

# Womanizer

THE ORIGINAL



## STARLET 3

MANUAL / MODE D'EMPLOI / BEDIENUNGSANLEITUNG /  
MANUAL DE INSTRUCCIONES / GEBRUIKSAANWIJZING /  
NÁVOD K OBSLUZE / ИНСТРУКЦИЯ ПО ЭКСПЛУАТАЦИИ /  
INSTRUKCJA OBSŁUGI / BRUKSANVISNING / MANUAL DE  
OPERAÇÃO / ISTRUZIONI PER L'USO / BRUGSANVISNING /  
BRUKSANVISNING / 操作说明 / 사용 설명서 / 快速入门用户指南 /  
取扱説明書

# Languages

ENGLISH

FRANCAIS

DEUTSCH

ESPAÑOL

NEDERLANDS

ČEŠTINA

РУССКИЙ

POLSKI

SVENSKA

PORTUGUÊS

ITALIANO

DANSK

NORSK

中文

한국어

繁體中文

にほんご

# Hi!

**Thank you for choosing Womanizer!**

Welcome to a world full of sensual experiences that will enrich your life. By choosing WOMANIZER, you are not only guaranteed orgasms that are beyond comparison – but also an entirely new lust for pleasure.

**Enjoy your WOMANIZER - one orgasm after another.**

Go, love yourself!



**PRODUCT DESCRIPTION**

**HOW TO USE**

**CHARGING**

**CLEANING**

**GENERAL INFORMATION**

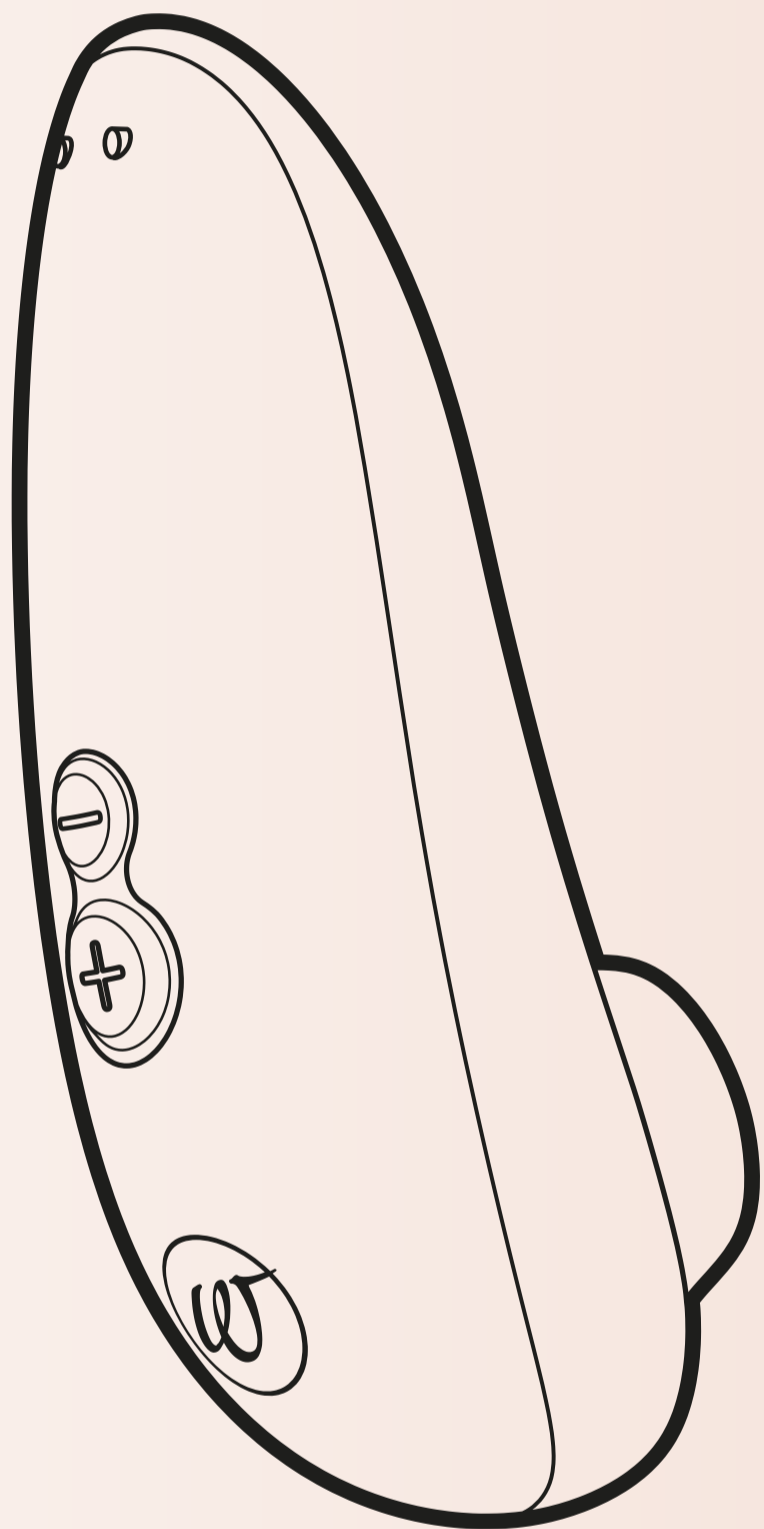

# PRODUCT DESCRIPTION

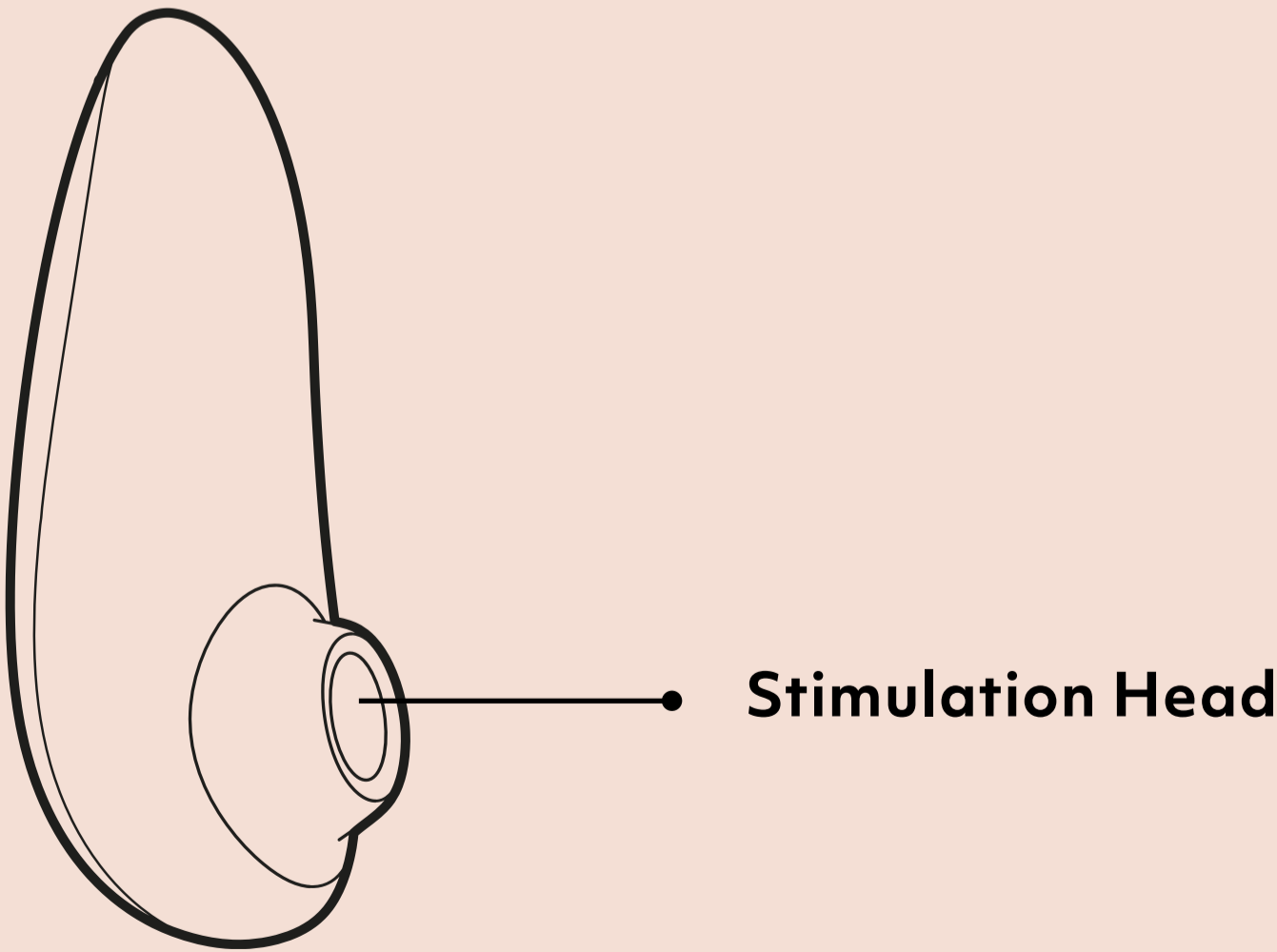
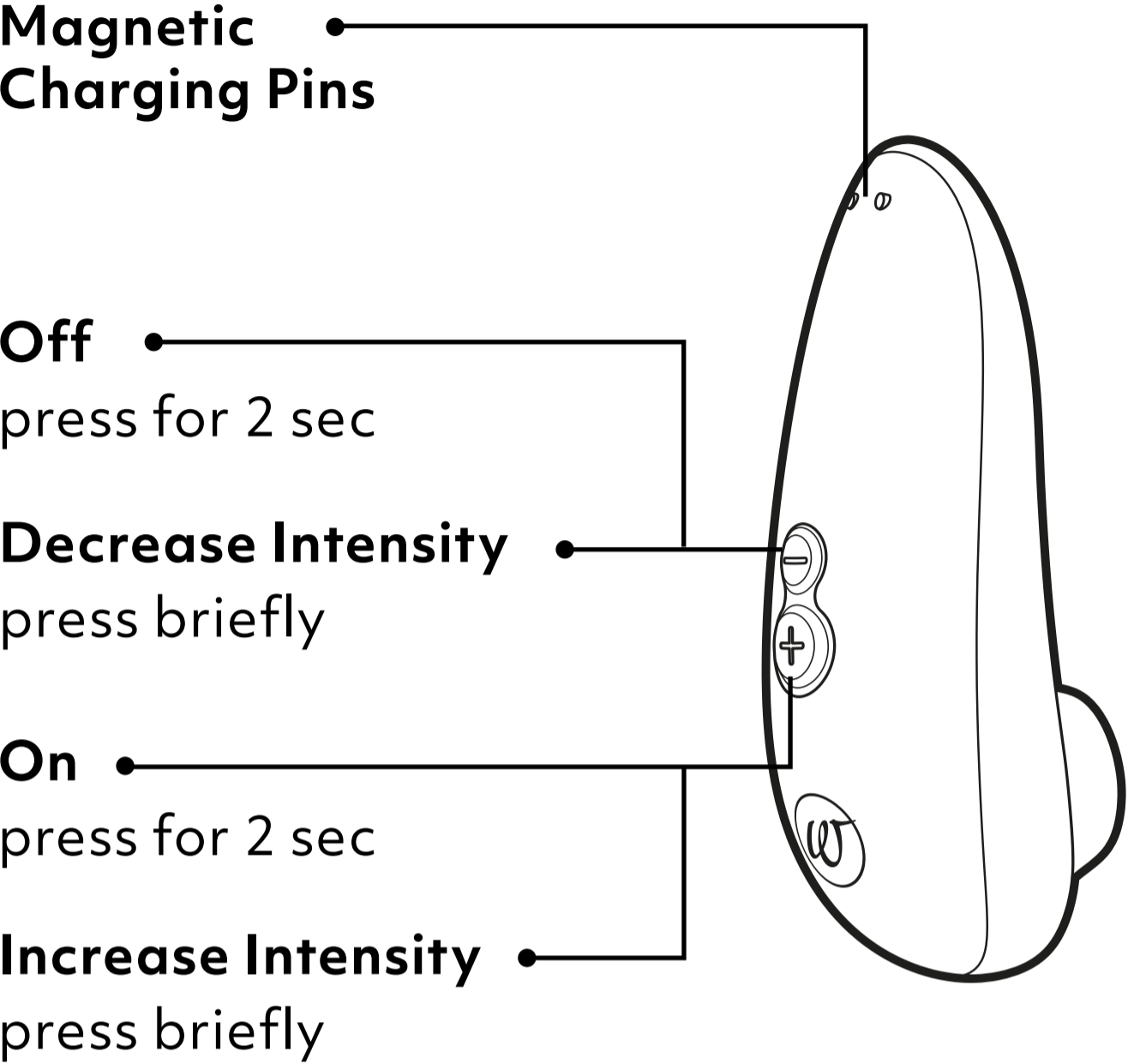

# HOW TO USE

## 1. Turn on

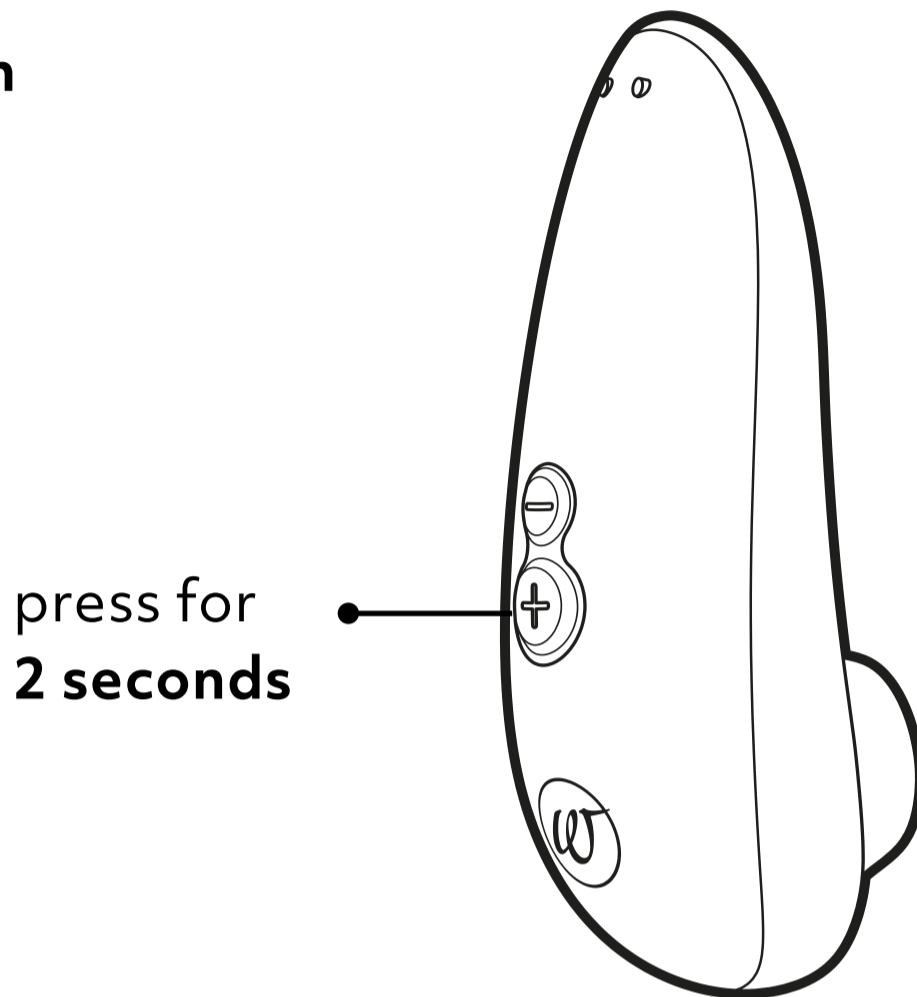

## 2. Usage

Surround your clitoris with the stimulation head and your journey begins.

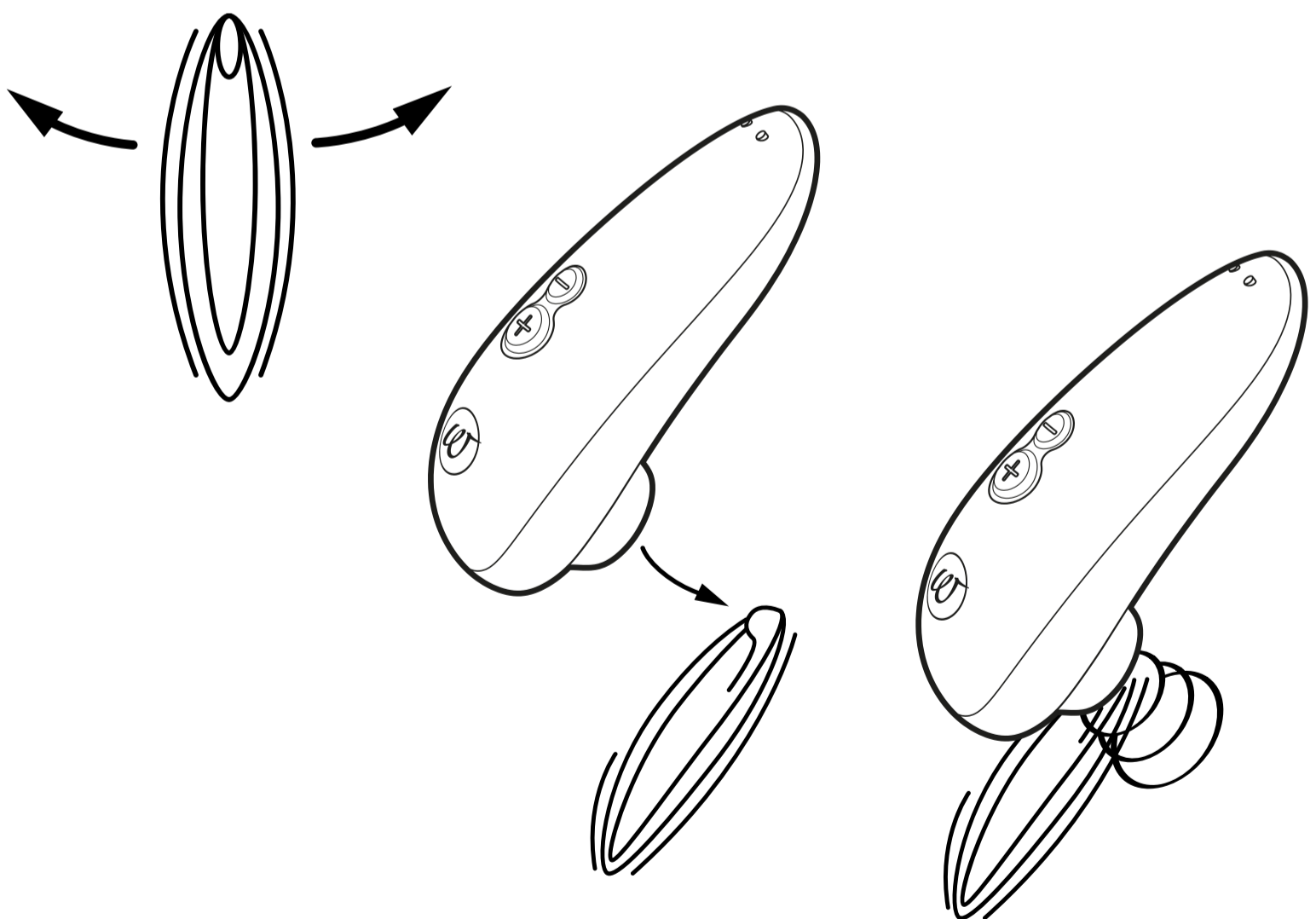

### 3. Change Intensity

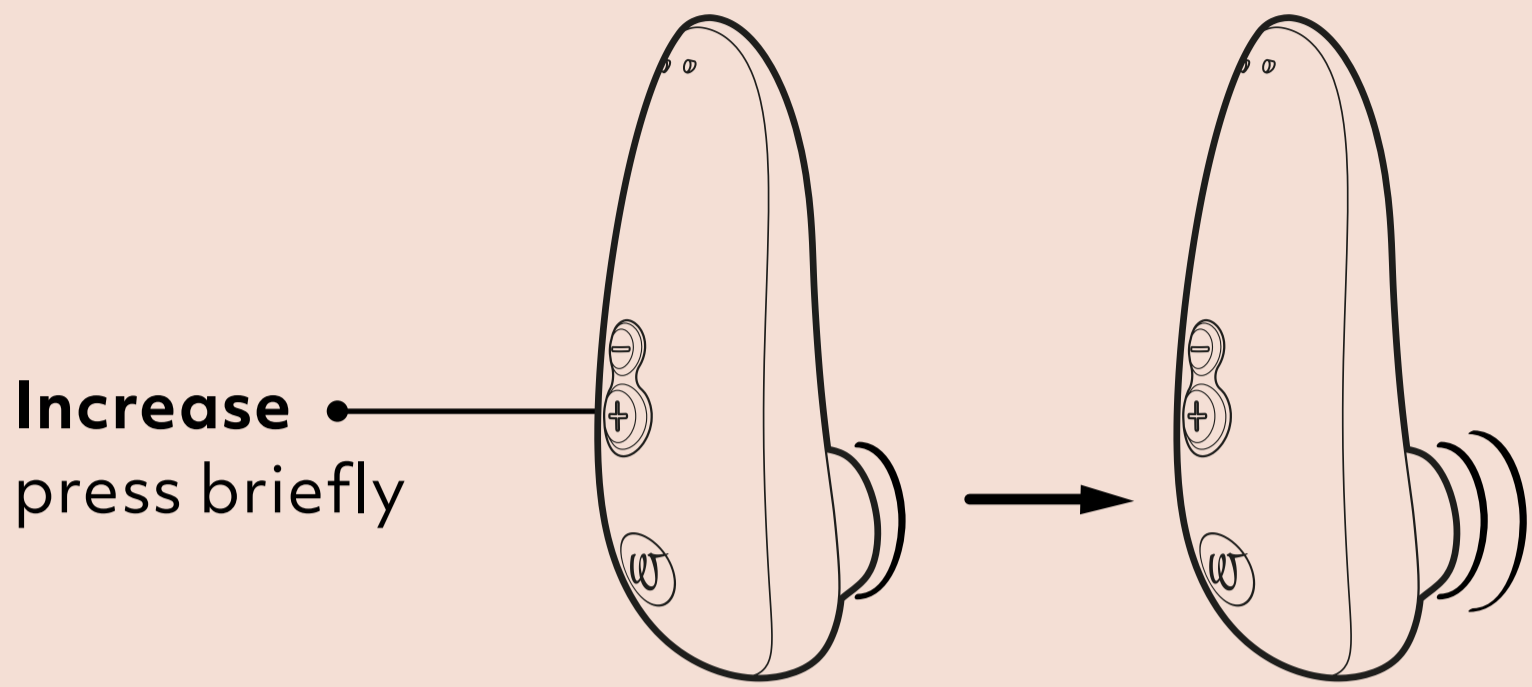

6  Intensity levels

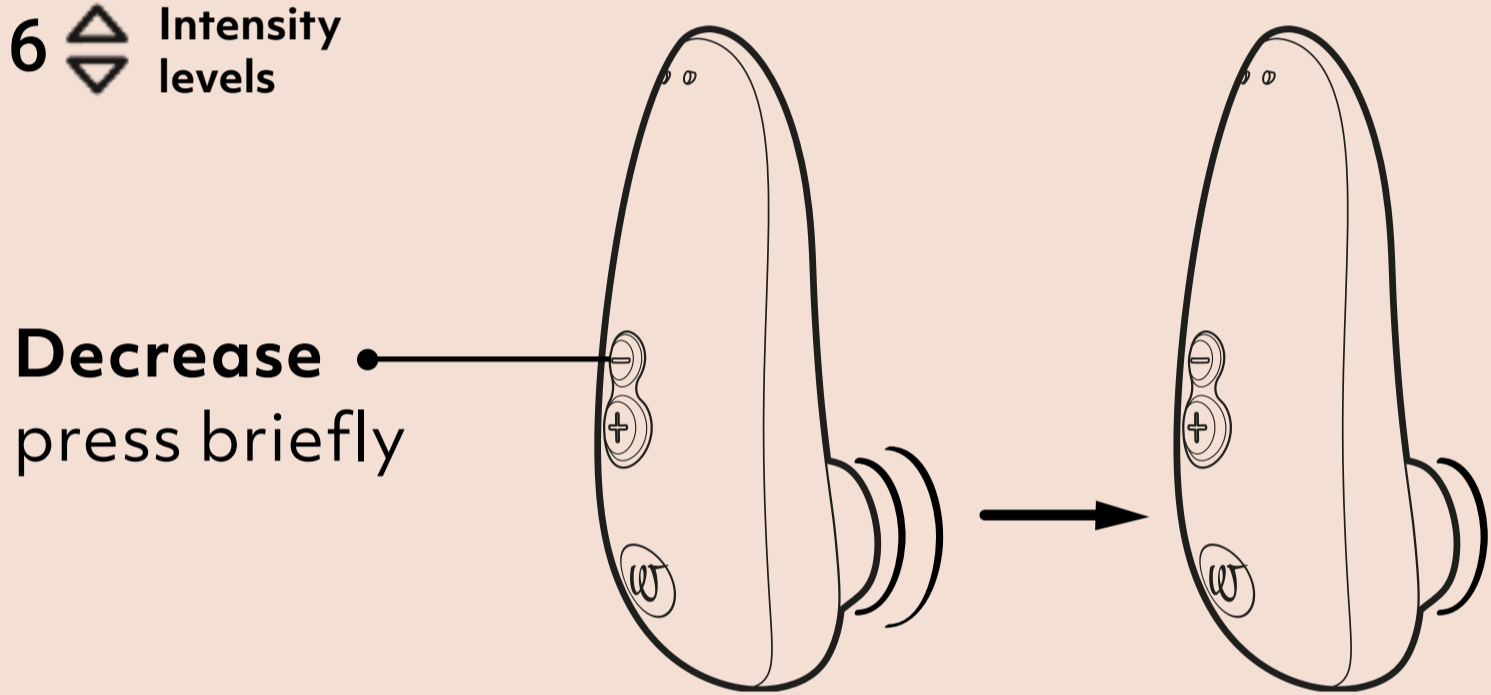

### 4. Turn off

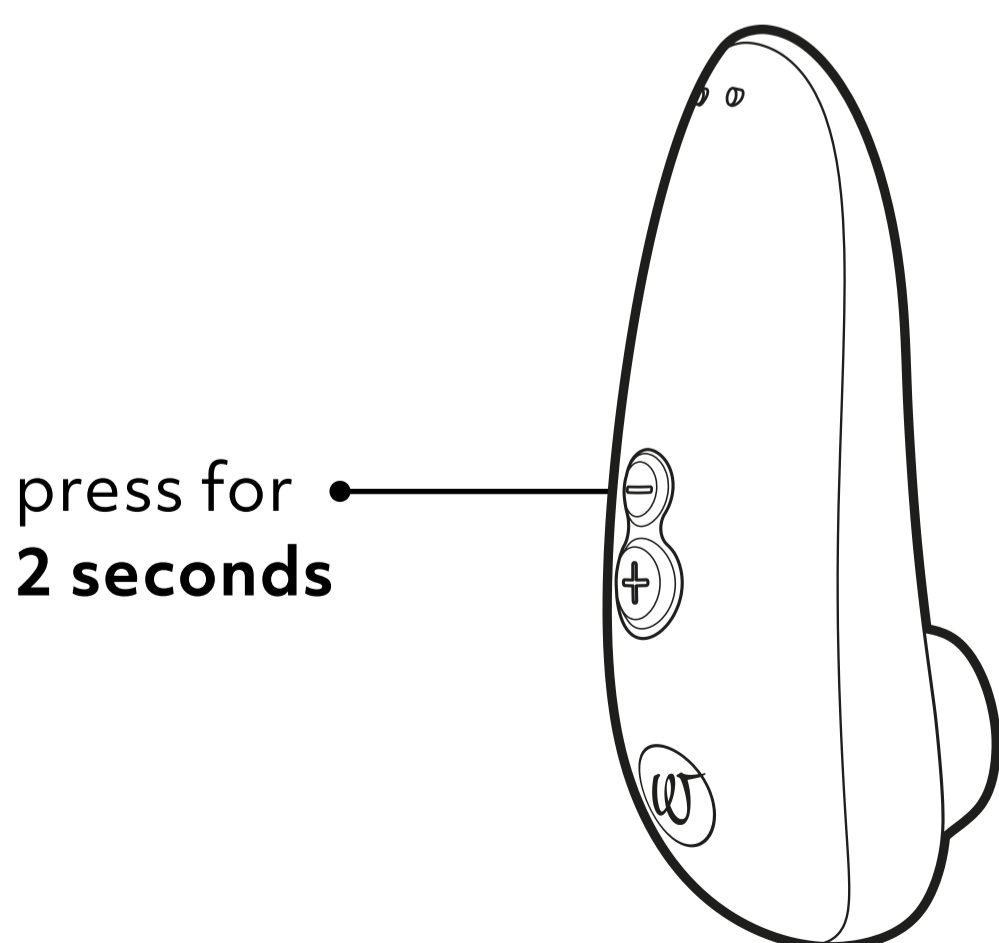



# CHARGING

Please charge your Womanizer before first use. Also keep in mind to recharge your Womanizer regularly, to ensure a long battery life.

## Charging

via USB port

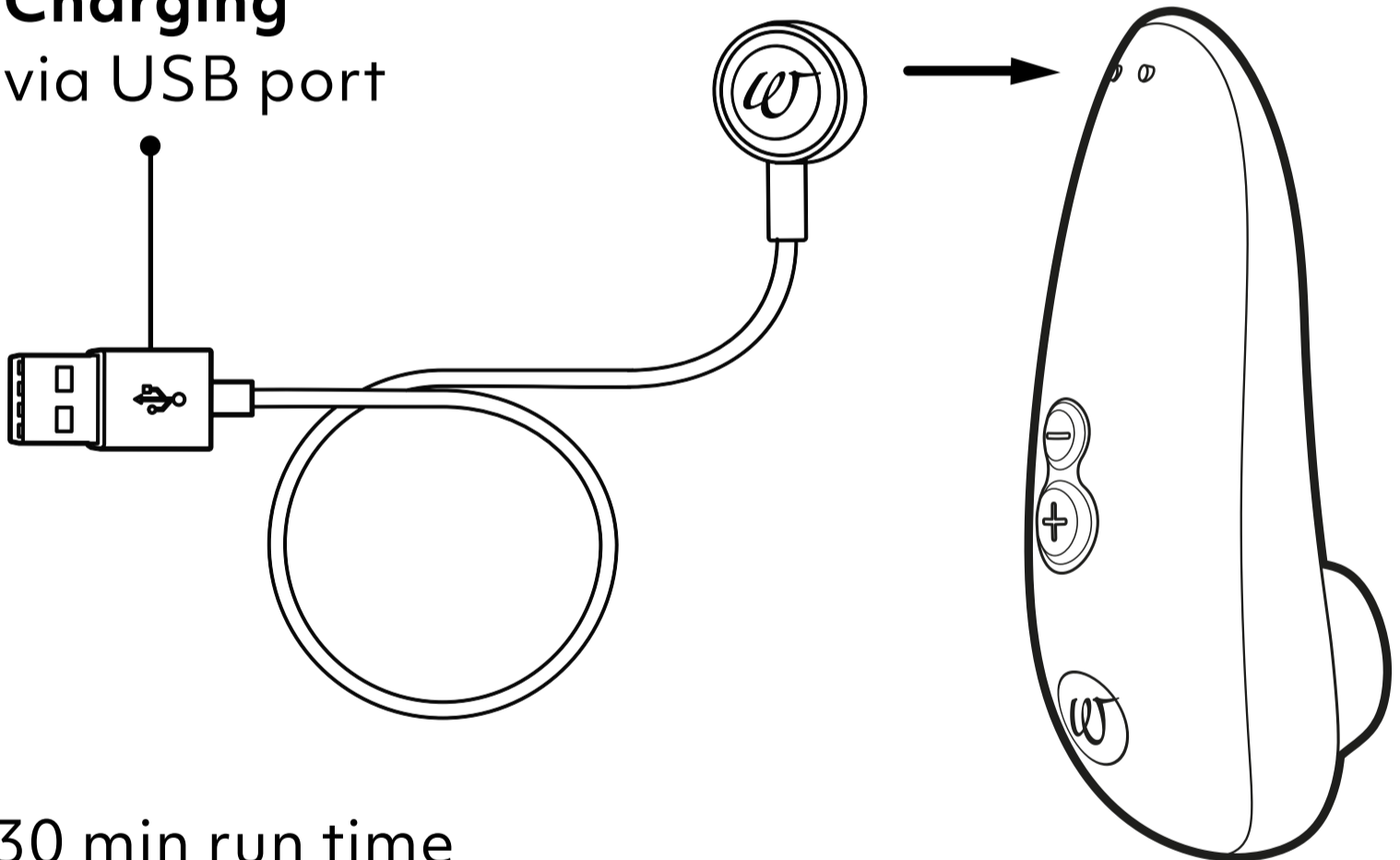

30 min run time

30 min for a full charge

# CLEANING

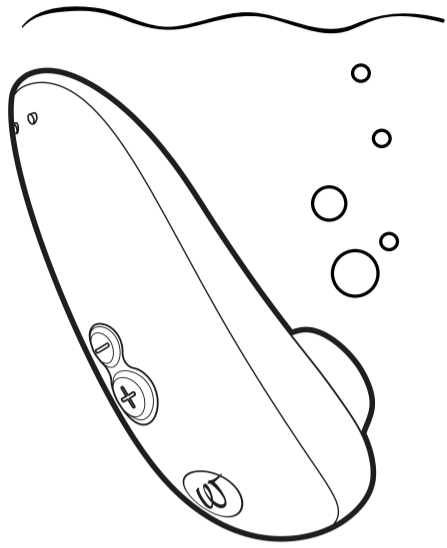

wash  
under water

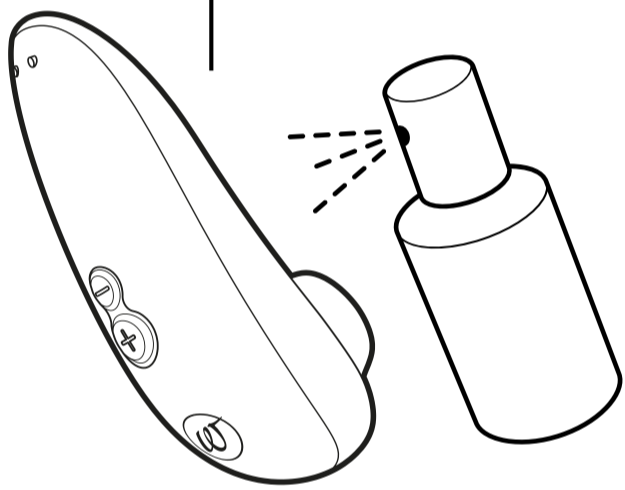

apply  
toy cleaner

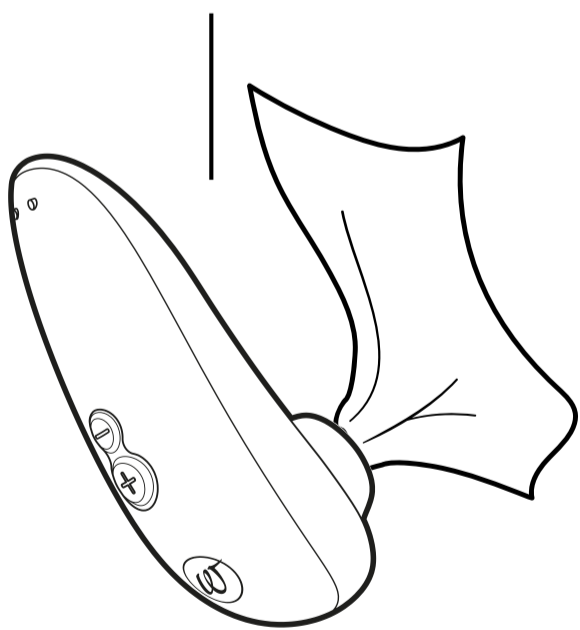

dry

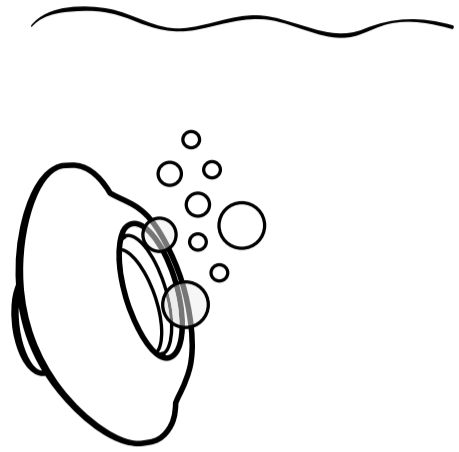

wash  
under water

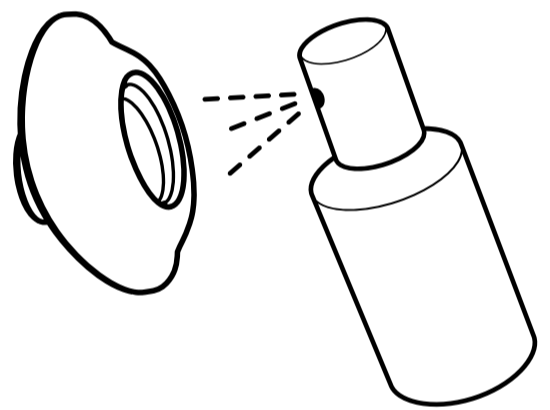

apply  
toy cleaner

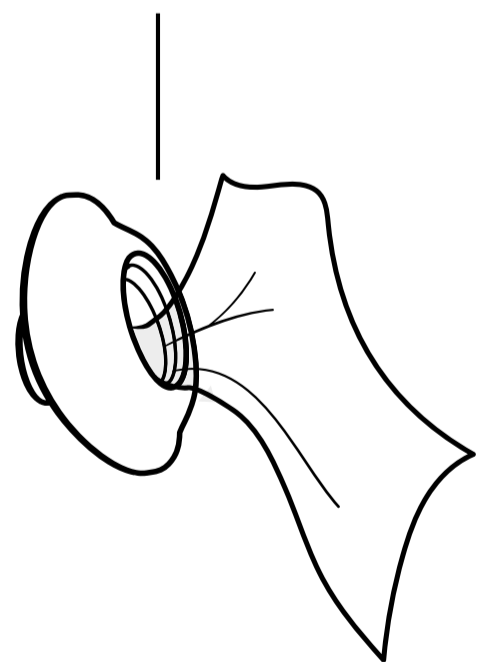

dry

+



Waterproof  
IPX7

# GENERAL INFORMATION

## WARNING

Do not use perfumed, alcohol- or silicone-based lube gels or massage oils while using your Womanizer to avoid damage. Thoroughly clean your Womanizer before using it to reduce the risk of infection.

## CUSTOMER CARE

For further information please visit our website [www.womanizer.com](http://www.womanizer.com) or contact [care@womanizer.com](mailto:care@womanizer.com).

## TECHNICAL SPECIFICATIONS

Model: WZ15B

Electrical rating: 3.7 V  $\approx$  0.135A :  
Built-in Lithium-Ion rechargeable battery. 5 V  $\approx$  0,75 A : When charged using USB.

Charging device:

USB AC adaptor (not included) with power output corresponding to product rating. Do not use fast-charging adaptor.

## CONTENT OF DELIVERY

Womanizer Starlet 3, USB charging cable, Quick start guide, Safety instructions.

## STORAGE

Store in a secure, dry place without exposure to direct sunlight.

## WARRANTY AND VOLUNTARY MANUFACTURER'S WARRANTY

WOW TECH EUROPE GMBH offers customers a voluntary manufacturer's warranty for this product in addition to the statutory warranty to which consumers are entitled with respect to sellers. The conditions with respect to the voluntary manufacturer's warranty are on our website, under „Warranty Conditions“.

## FULFILLMENT OF STANDARDS

This appliance complies with all standards regarding electromagnetic compatibility (EMC). The device is safe to use as long as it is used correctly and in accordance with the instructions given in this user manual. EAR registration number: DE 74619272

## ENVIRONMENTAL PROTECTION

As a distributor of electronic devices, we are legally obliged to accept the return of waste electrical and electronic devices free of charge. We expressly state that you as the user are legally obliged to return used batteries. Never throw away electronic devices or batteries in the household waste. The symbol shown below, which is also attached to our electronic items, is intended to expressly remind you of this.

## DISTRIBUTOR

WOW TECH EUROPE GMBH  
Friedenstrasse 91 / 91 A  
10249 Berlin, Germany

WOW TECH EUROPE GMBH reserves the right to make technical changes and changes to the design that serve to improve the device.

Distributed in North America by  
WOW TECH Canada Ltd.  
330-1130 Morrison Drive  
Ottawa, Ontario, Canada K2H 9N6

[www.wowtech.com](http://www.wowtech.com)

Date of issue: 05/2021. Version 1.

Designed in Germany. Made in China in 2021.

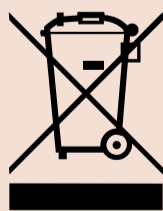

# STILL WANT MORE?

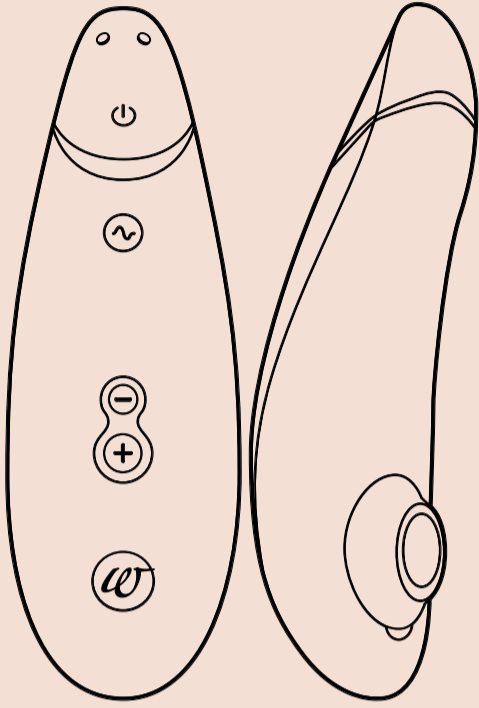

**Pleasure Air  
Technology**



**Smart Silence**

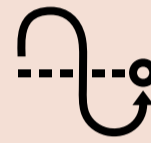

**Autopilot**

**Premium 2**  
Define your luxury

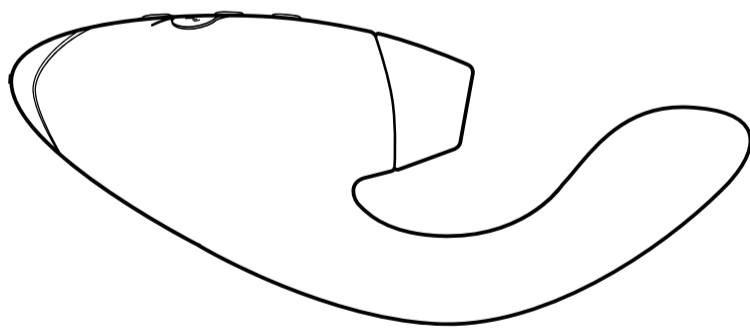

**Pleasure Air  
Technology**



**Vibrator**

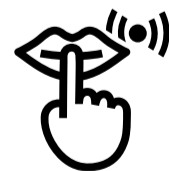

**Smart Silence**

**DUO**  
Double your Pleasure



**#IMASTURBATE**

# Bonjour !

**Nous vous remercions d'avoir choisi le Womanizer !**

Bienvenue dans un univers rempli d'expériences sensuelles qui vont enrichir votre vie. En choisissant le WOMANIZER, vous allez non seulement ressentir des orgasmes incomparables, mais aussi un désir de plaisir entièrement nouveau. Faites-vous plaisir !

**Profitez de votre WOMANIZER - un orgasme l'un après l'autre.**

Donnez-vous du plaisir !



**DESCRIPTION PRODUIT**

**COMMENT L'UTILISER**

**LA CHARGE**

**L'ENTRETIEN**

**DESCRIPTION PRODUIT**

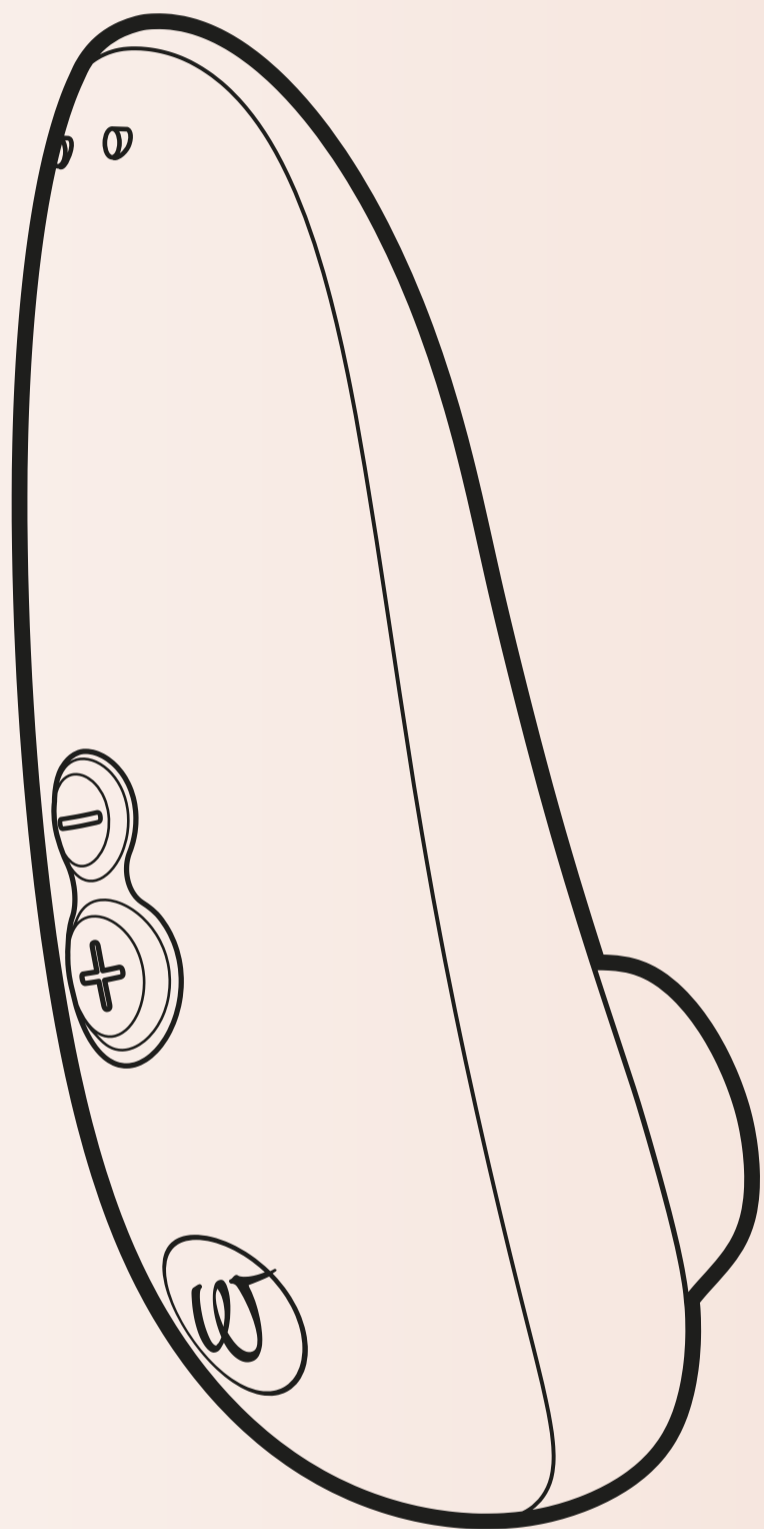



# DESCRIPTION PRODUIT

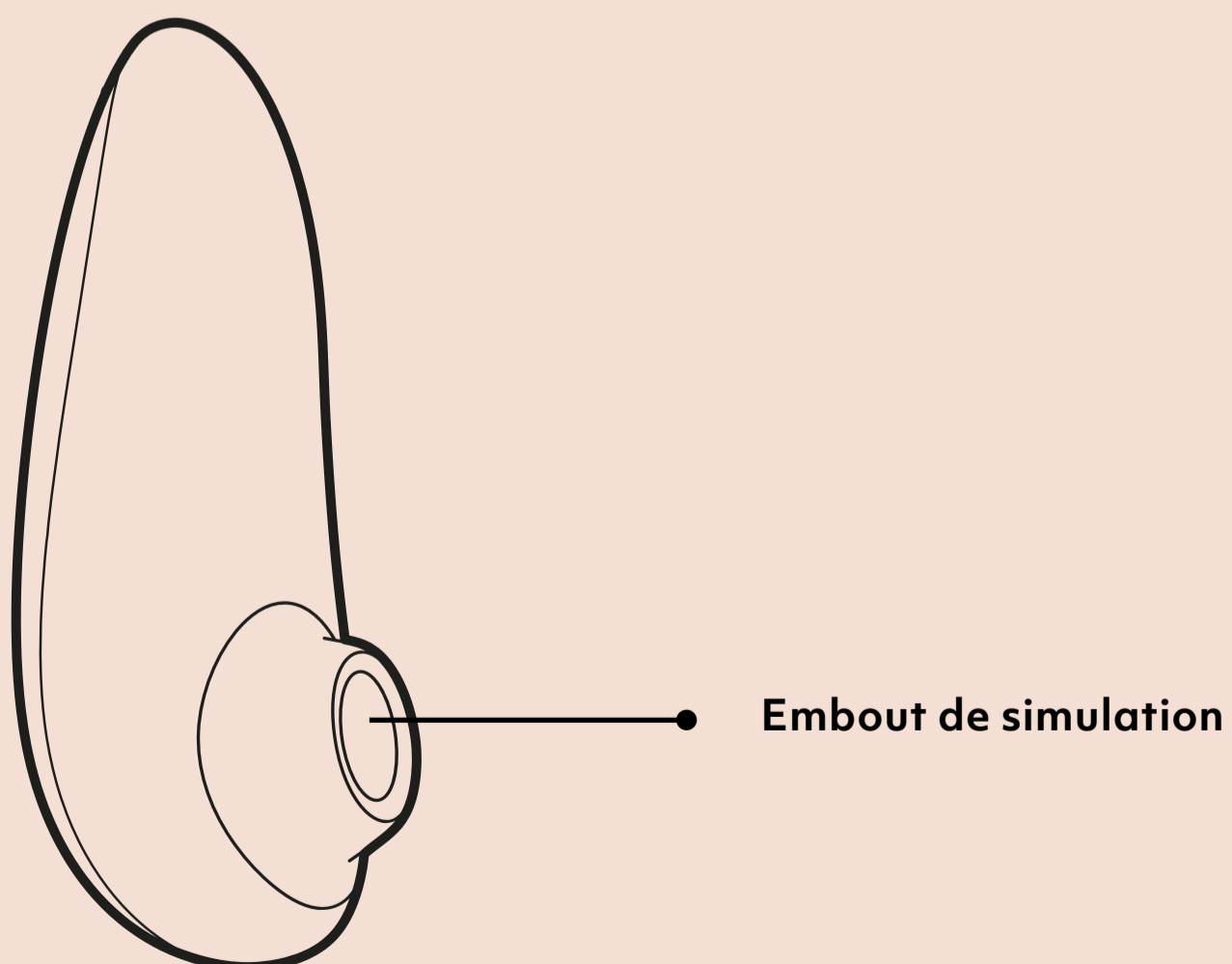
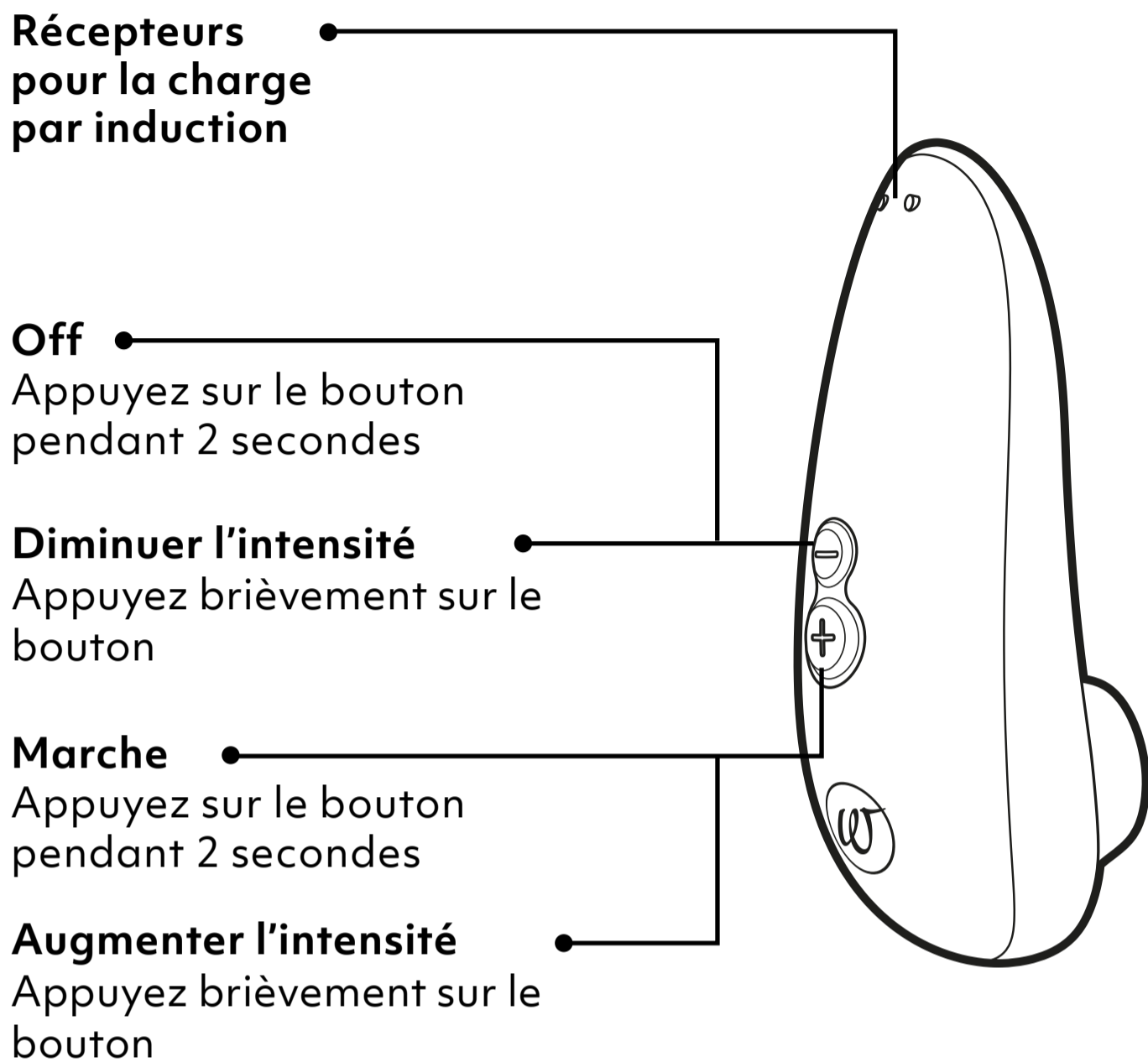

# COMMENT L'UTILISER

## 1. Allumer

Appuyez pendant  
2 secondes

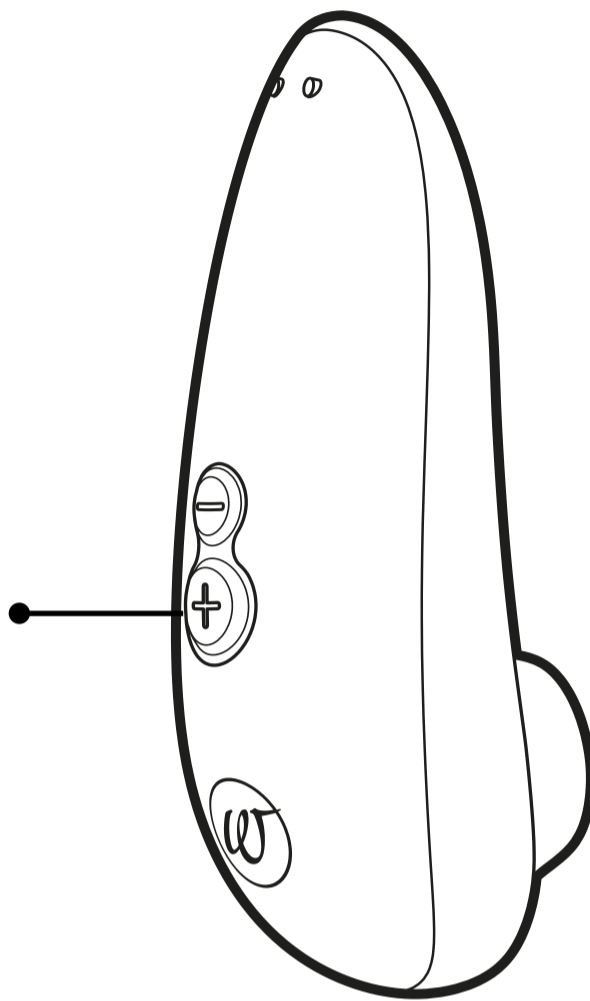

## 2. Utilisation

Enveloppez votre clitoris avec la tête de stimulation et débutez votre voyage.

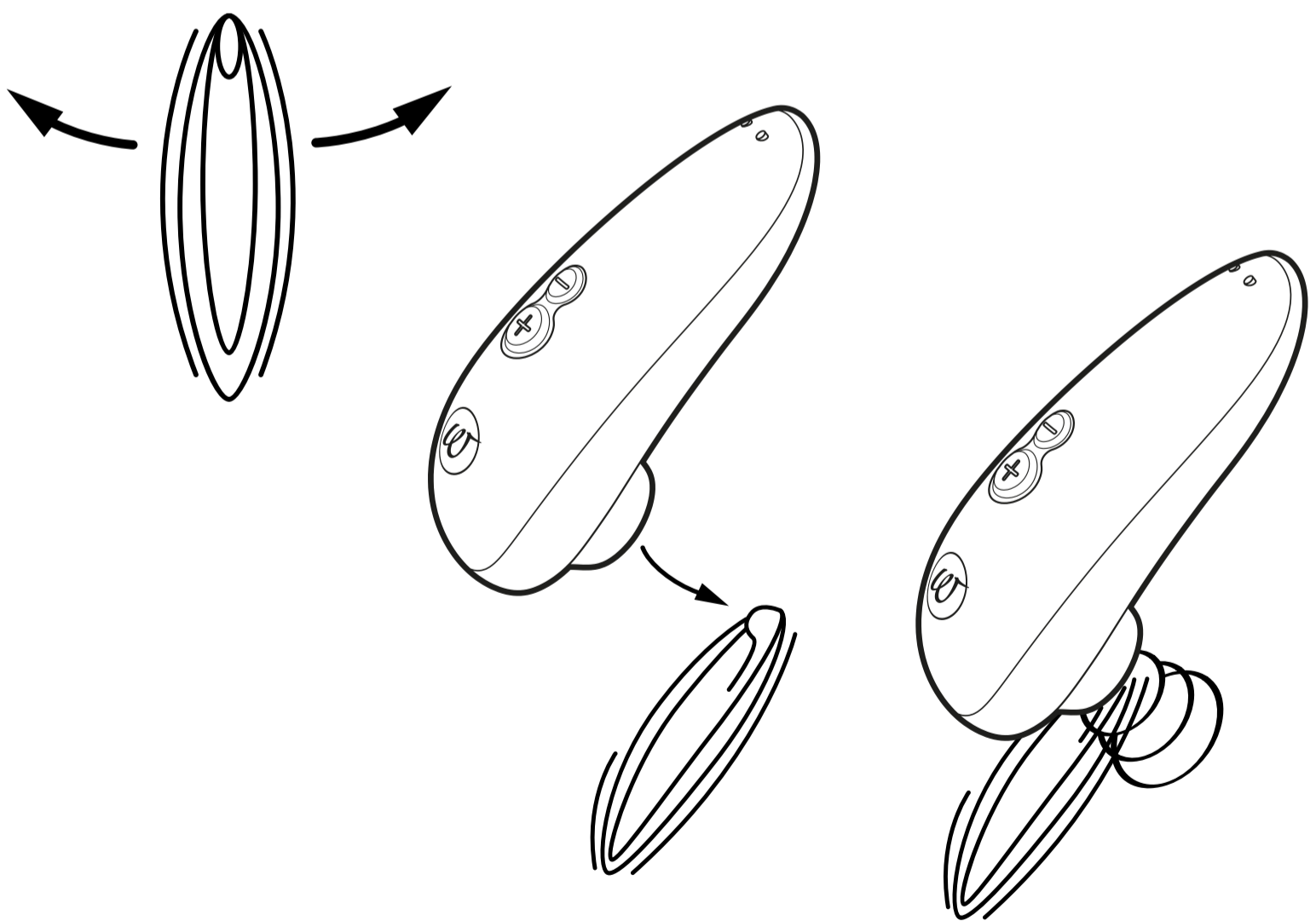

### 3. Régler l'intensité

**Augmenter**  
Appuyez brièvement sur le bouton

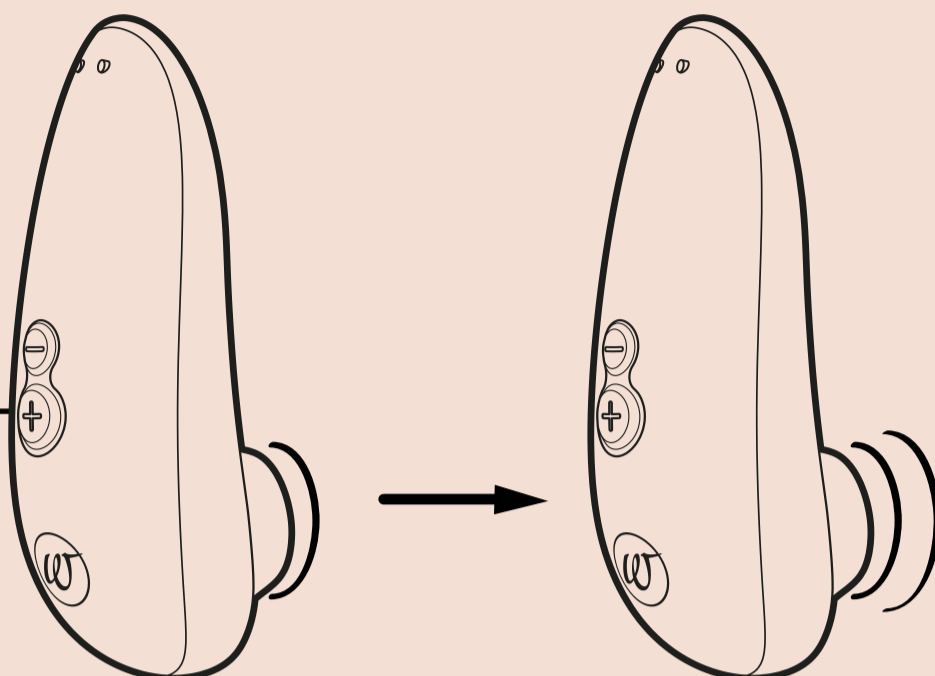

**6**  Niveaux d'intensité

**Diminuer**  
Appuyez brièvement sur le bouton

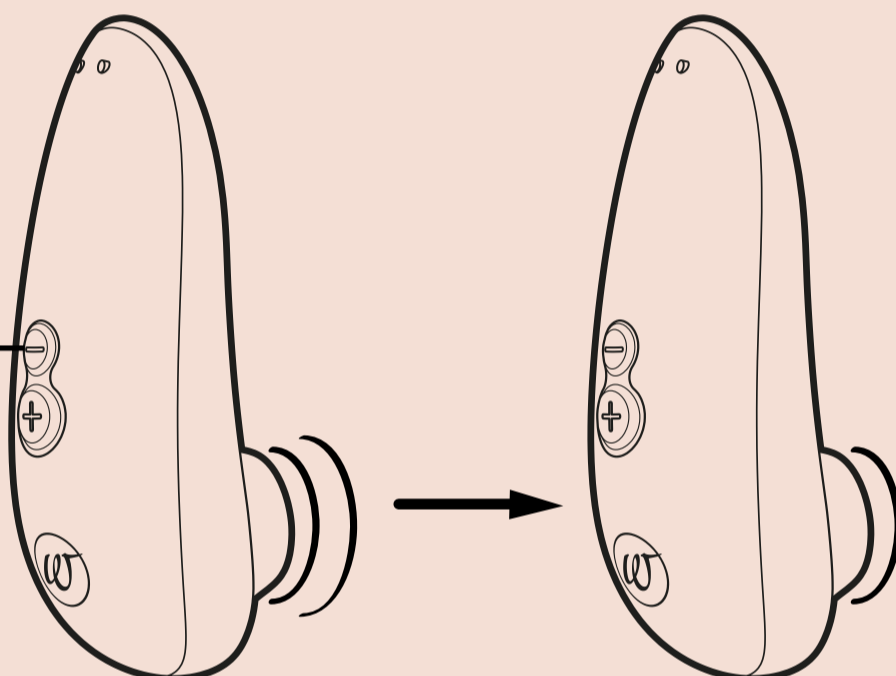

### 4. Éteindre

Appuyez sur le bouton pendant **2 secondes**

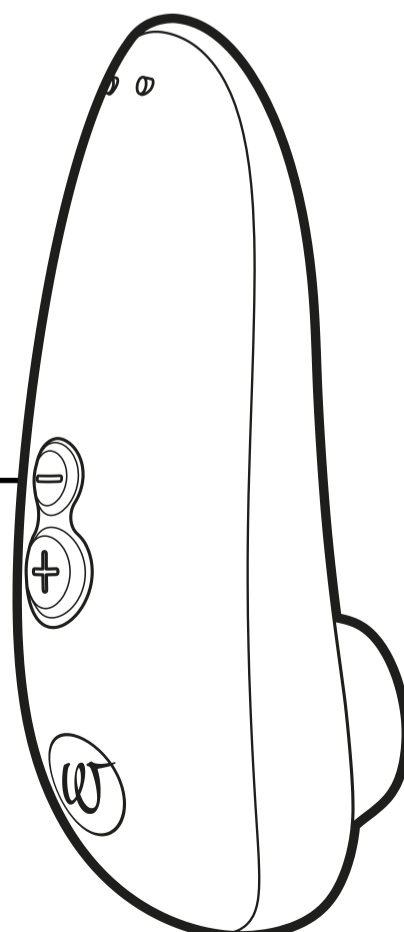

# LA RECHARGE

Veillez charger votre Womanizer avant la première utilisation.  
N'oubliez pas de recharger régulièrement votre Womanizer  
afin de garantir une longue autonomie de la batterie.

**La recharge**  
via le port USB

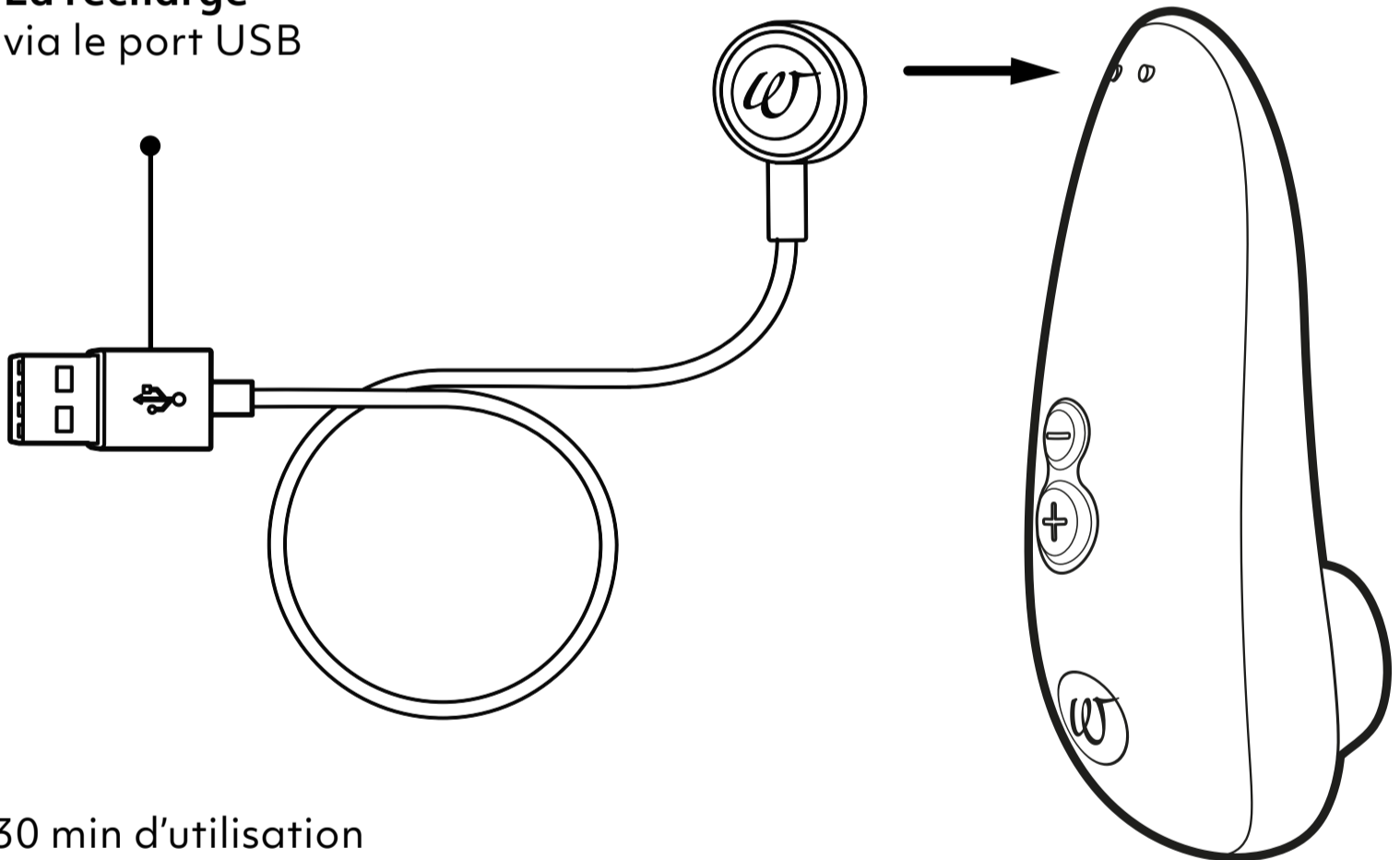

30 min d'utilisation  
30 min pour une charge complète

# L'ENTRETIEN

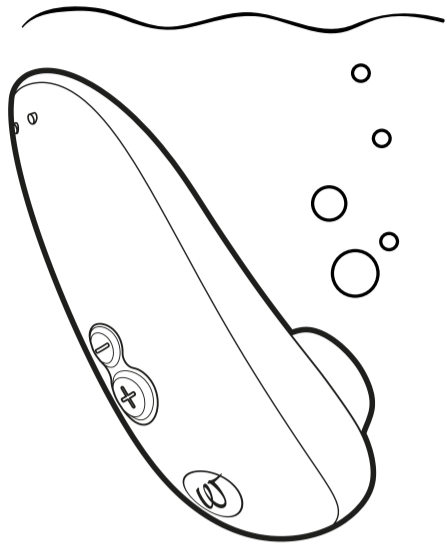

Lavez votre appareil  
sous l'eau

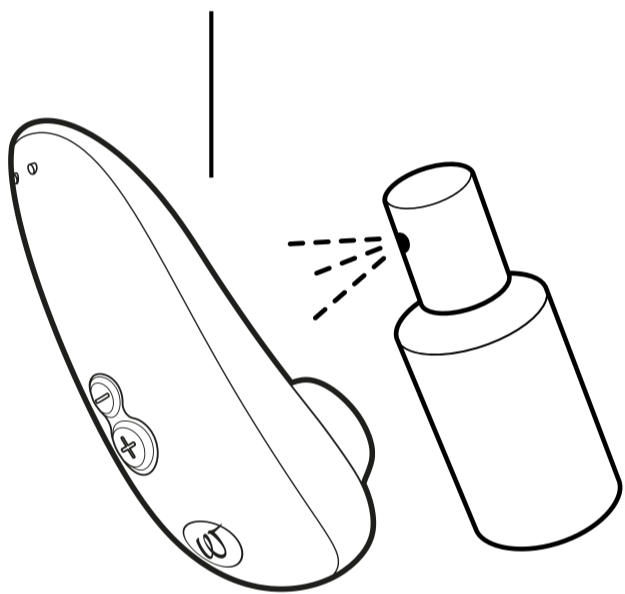

Utilisez un nettoyant  
pour sextoys

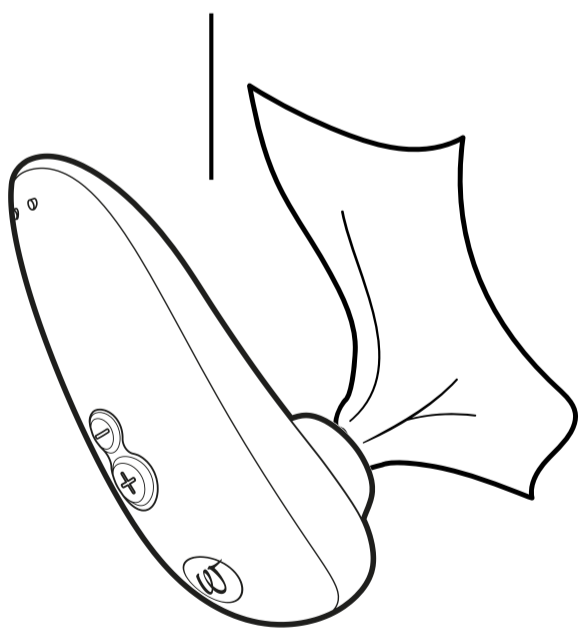

Séchage

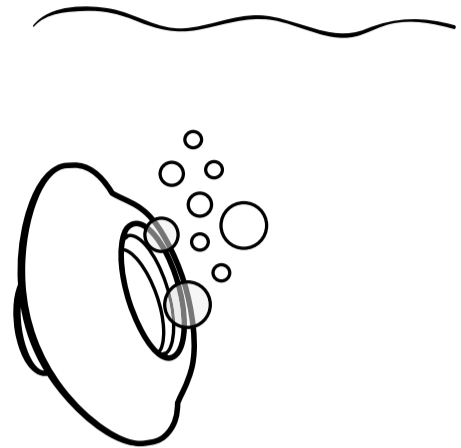

Lavez votre appareil  
sous l'eau

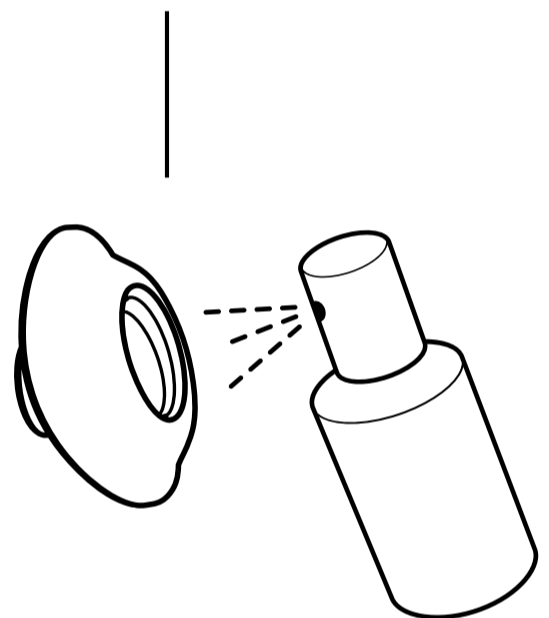

Utilisez un nettoyant  
pour sextoys

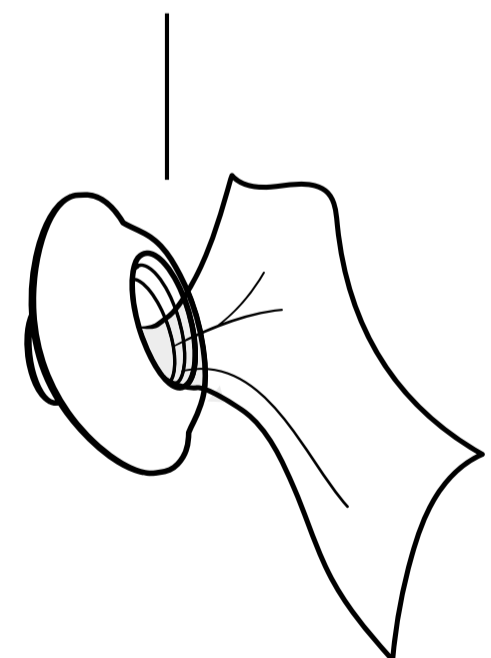

Séchage



Waterproof  
IPX7

# INFORMATIONS GÉNÉRALES

## AVERTISSEMENT

N'utilisez pas de gels lubrifiants parfumés ou à base d'alcool ou de silicone ou d'huiles de massage avec votre Womanizer pour éviter tout dommage. Nettoyez soigneusement votre Womanizer avant de l'utiliser pour la première fois et après chaque nouvel usage afin de minimiser le risque d'infection.

## SERVICE CLIENTÈLE

Pour de plus amples informations, rendez-vous sur notre site web [www.womanizer.com](http://www.womanizer.com) ou contactez [care@womanizer.com](mailto:care@womanizer.com).

## CARACTÉRISTIQUES TECHNIQUES

Modèle : WZ15B

Puissance nominale : 3.7  $\pm$  0.135 A :  
Batterie lithium-Ion rechargeable incluse.

5 V  $\pm$  0.75 A : Lorsque rechargée avec l'USB.

Chargeur :

adaptateur USB AC (non inclus) doté d'une puissance électrique correspondant à la puissance nominale. N'utilisez pas d'adaptateur de charge rapide.

## CONTENU DE L'EMBALLAGE

Womanizer Starlet 3, câble de charge USB, un guide de démarrage rapide, consignes de sécurité.

## RANGEMENT

À conserver dans un endroit sûr, et sec sans exposition directe aux rayons du soleil.

## GARANTIE ET GARANTIE DU FABRICANT

WOW TECH EUROPE GMBH offre à ses clients une garantie fabricant pour ce produit en supplément de la garantie obligatoire accordée aux consommateurs.

Vous pouvez consulter les conditions relatives à notre garantie fabricant sur notre site Internet dans la rubrique « Conditions de garantie ».

## RESPECT DES NORMES

Cet appareil répond à toutes les normes relatives à la compatibilité élec-

tromagnétique (CEM). Cet appareil ne présente aucun danger dans la mesure où il est utilisé correctement dans le respect des instructions fournies dans le manuel d'utilisateur.

## PROTECTION ENVIRONNEMENTALE

En tant que distributeur d'appareils électroniques, nous sommes légalement tenus par la loi d'accepter gratuitement le retour des déchets des équipements électriques et électroniques. Nous vous informons explicitement qu'en tant qu'utilisateur, vous êtes légalement tenu de retourner les batteries utilisées. Ne jetez jamais des appareils électroniques ou des batteries avec les déchets ménagers. Le symbole présenté ci-dessous et également présent sur nos appareils électroniques sert à vous rappeler expressément cette obligation.

## DISTRIBUTEUR

WOW Tech Europe GmbH,  
Friedenstrasse 91 / 91 a, 10249 Berlin, Allemagne

WOW Tech Europe GmbH se réserve le droit de procéder à des modifications techniques ou de la conception de ce produit afin de l'optimiser.

Distribué en Amérique du Nord par WOW TECH Canada Ltd. 1545 Carling Avenue, Suite 401, Ottawa ON, Canada K1Z 8P9

[www.wowtech.com](http://www.wowtech.com) Conçu en Allemagne. Produit en Chine en 2021. Manuel publié en 02/2021. Version 1.

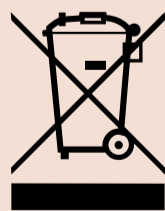

# ENVIE DE PLUS ?

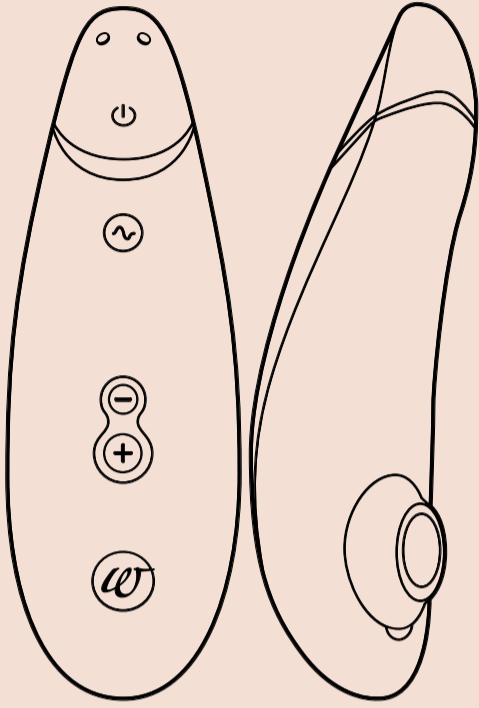

**Pleasure Air  
Technology**



**Smart Silence**

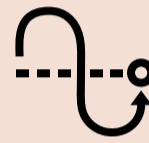

**Autopilot**

## **Premium 2**

Define your luxury

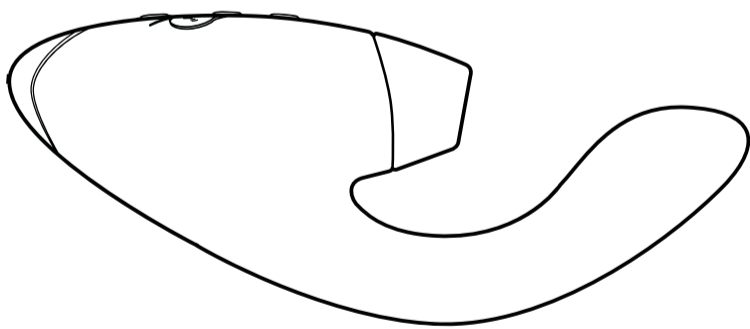

**Pleasure Air  
Technology**



**Vibrator**



**Smart Silence**

## **DUO**

Double your Pleasure

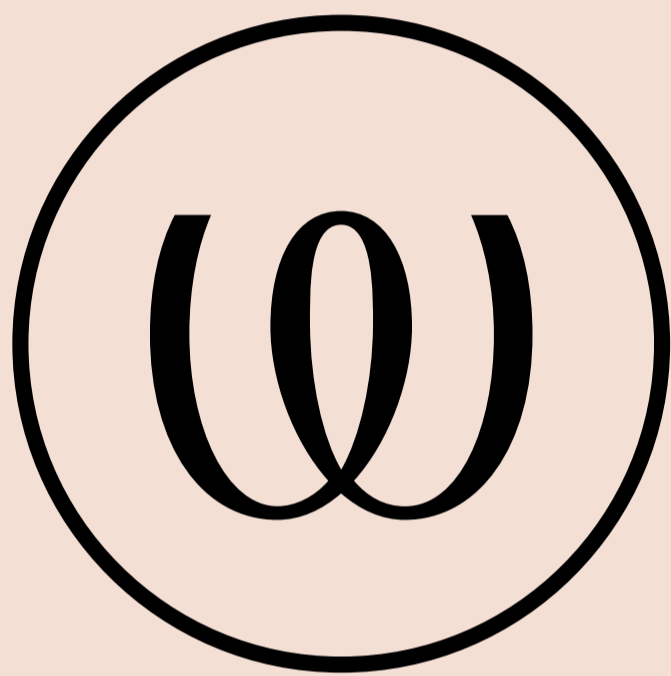

**#IMASTURBATE**



# Hi!

**Schön, dass Du Dich für den Womanizer entschieden hast!**

Wir heißen Dich willkommen in einer Welt voll sinnlicher Erlebnisse, die Dein Leben bereichern werden. Mit der Entscheidung für den WOMANIZER sind Dir nicht nur unvergleichliche Orgasmen sicher – sondern auch ein vollkommen neues Lustgefühl.

**Hab viel Freude mit Deinem WOMANIZER – und einen Orgasmus nach dem anderen.**

Liebe Dich selbst!



**PRODUKTBESCHREIBUNG**

**BENUTZUNG**

**LADEN**

**REINIGUNG**

**ALLGEMEINE INFORMATIONEN**

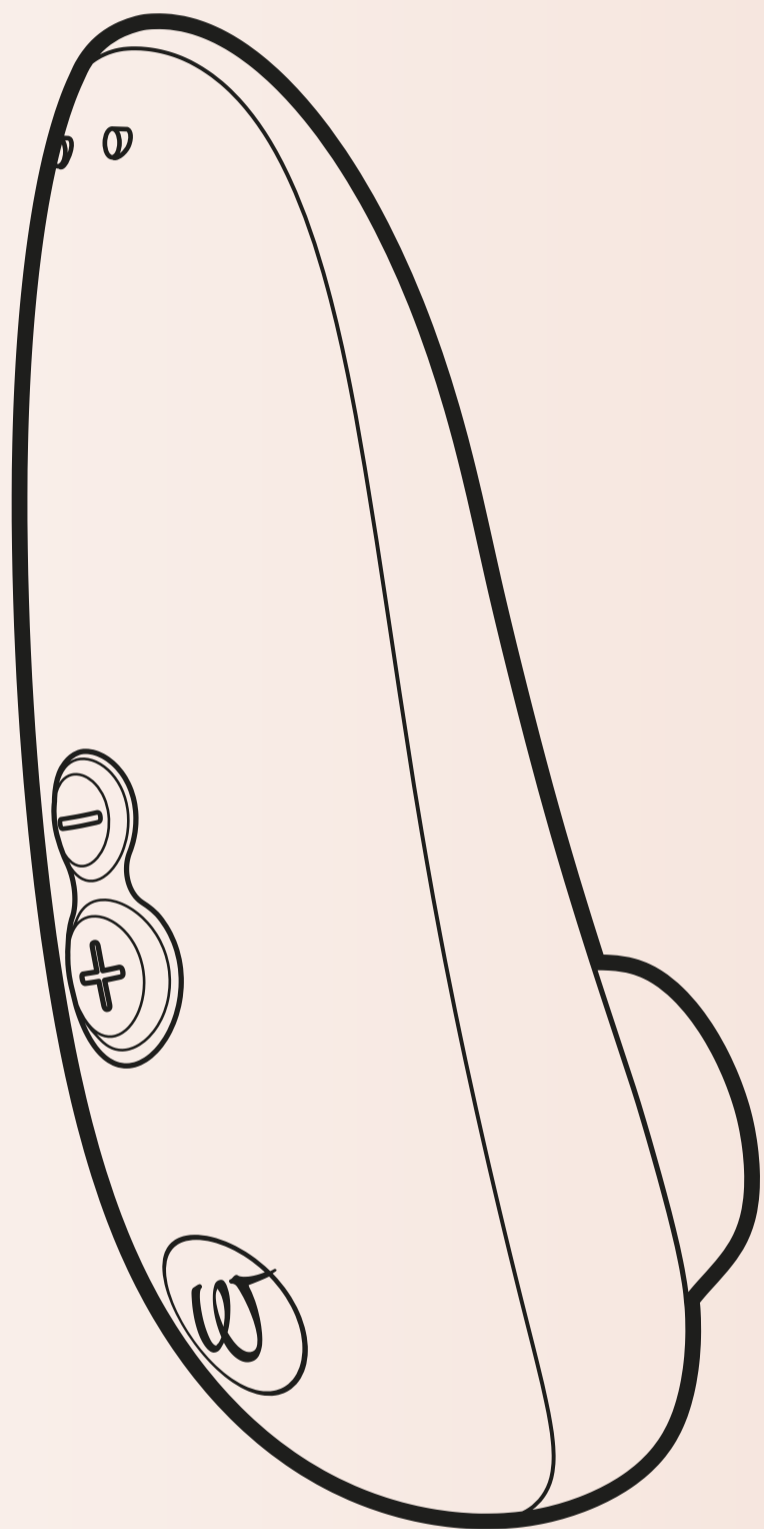

# PRODUKTBESCHREIBUNG

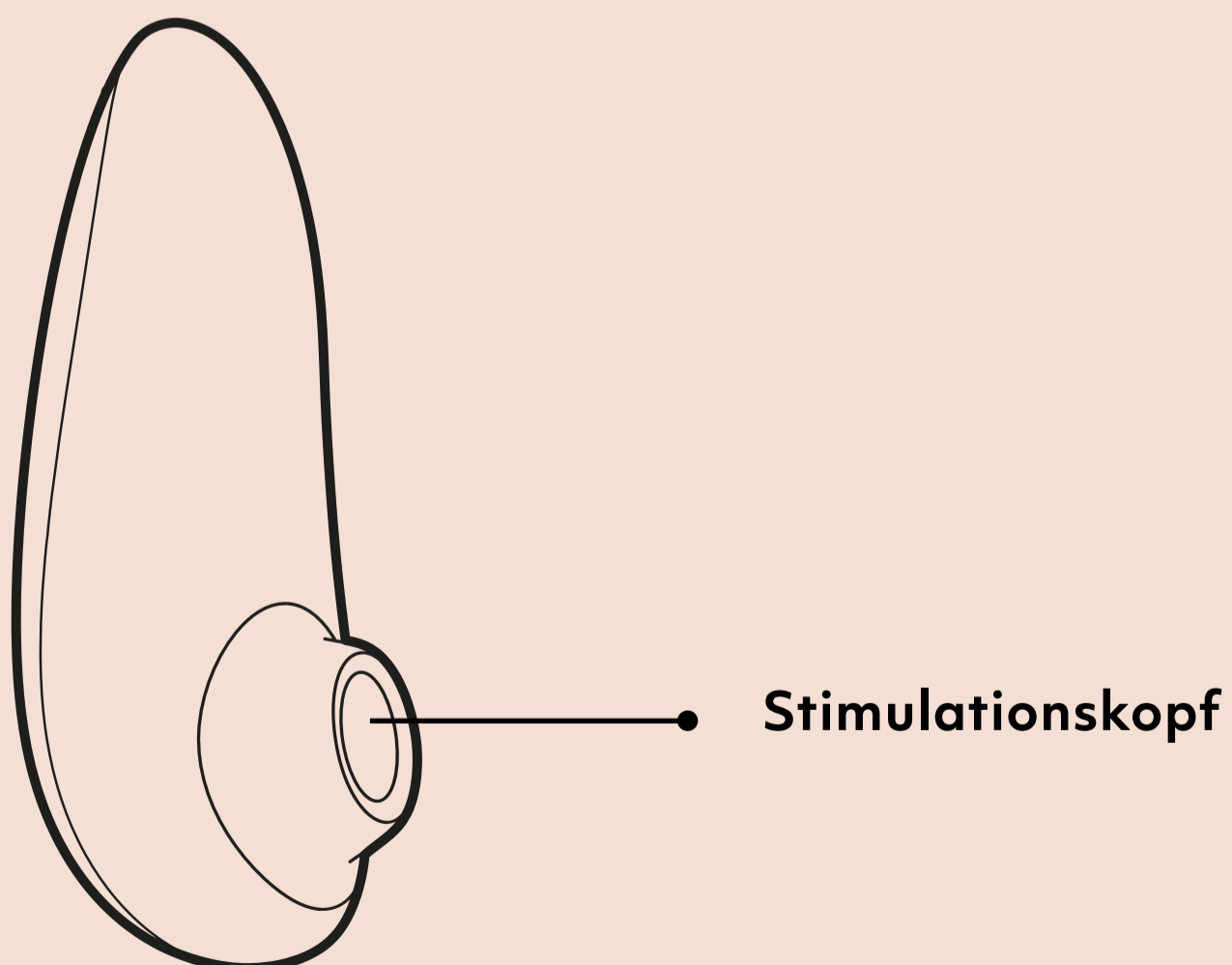
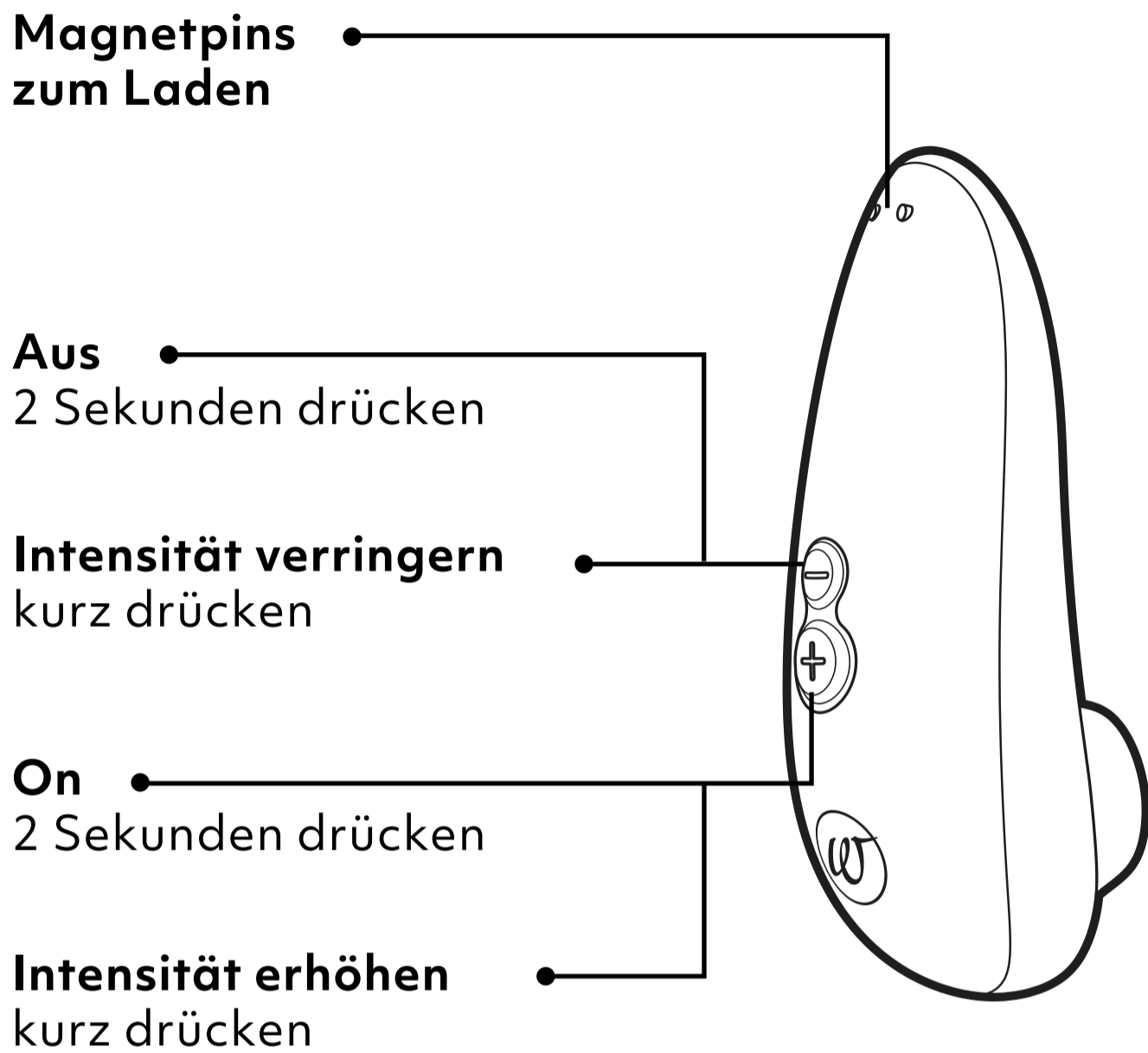

# BENUTZUNG

## 1. Einschalten

2 Sekunden  
drücken

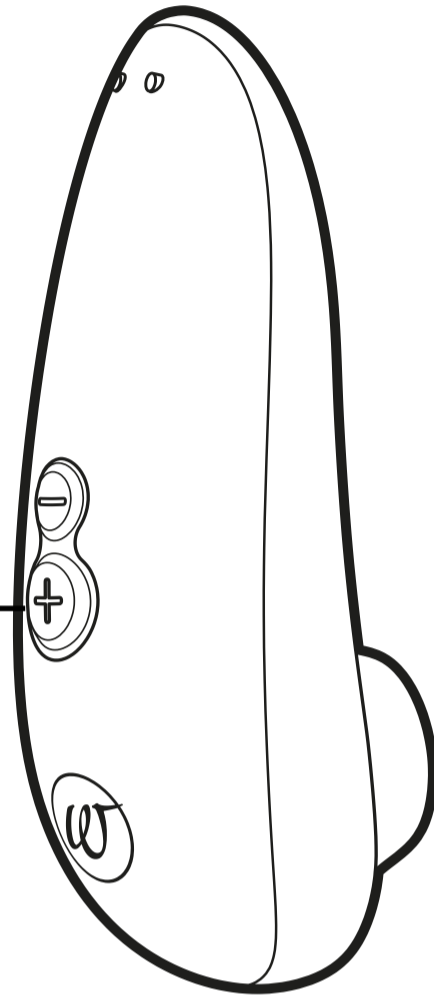

## 2. Benutzung

Lege den Stimulationskopf auf die Klitoris und lass Dich verwöhnen.

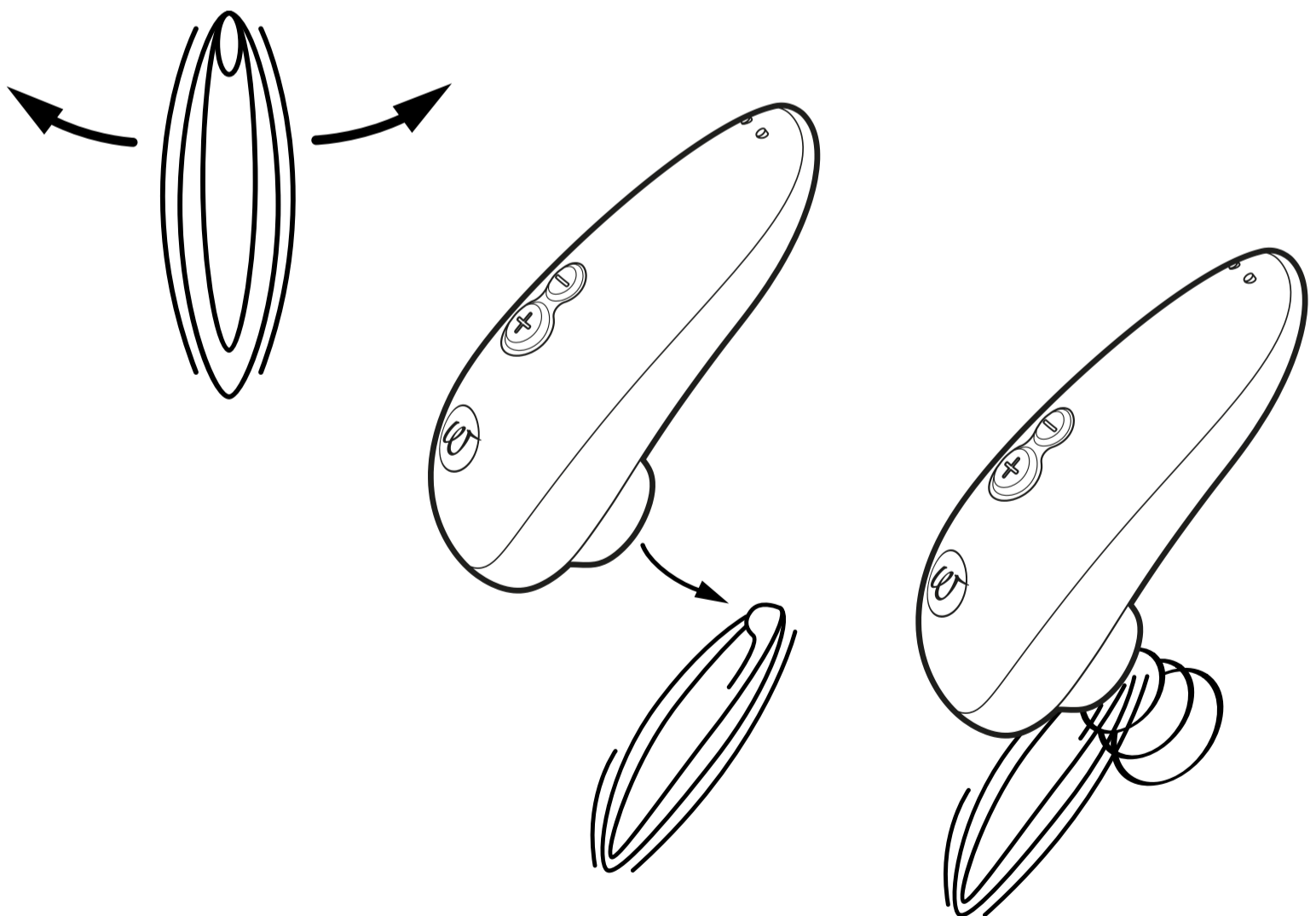

### 3. Intensität ändern

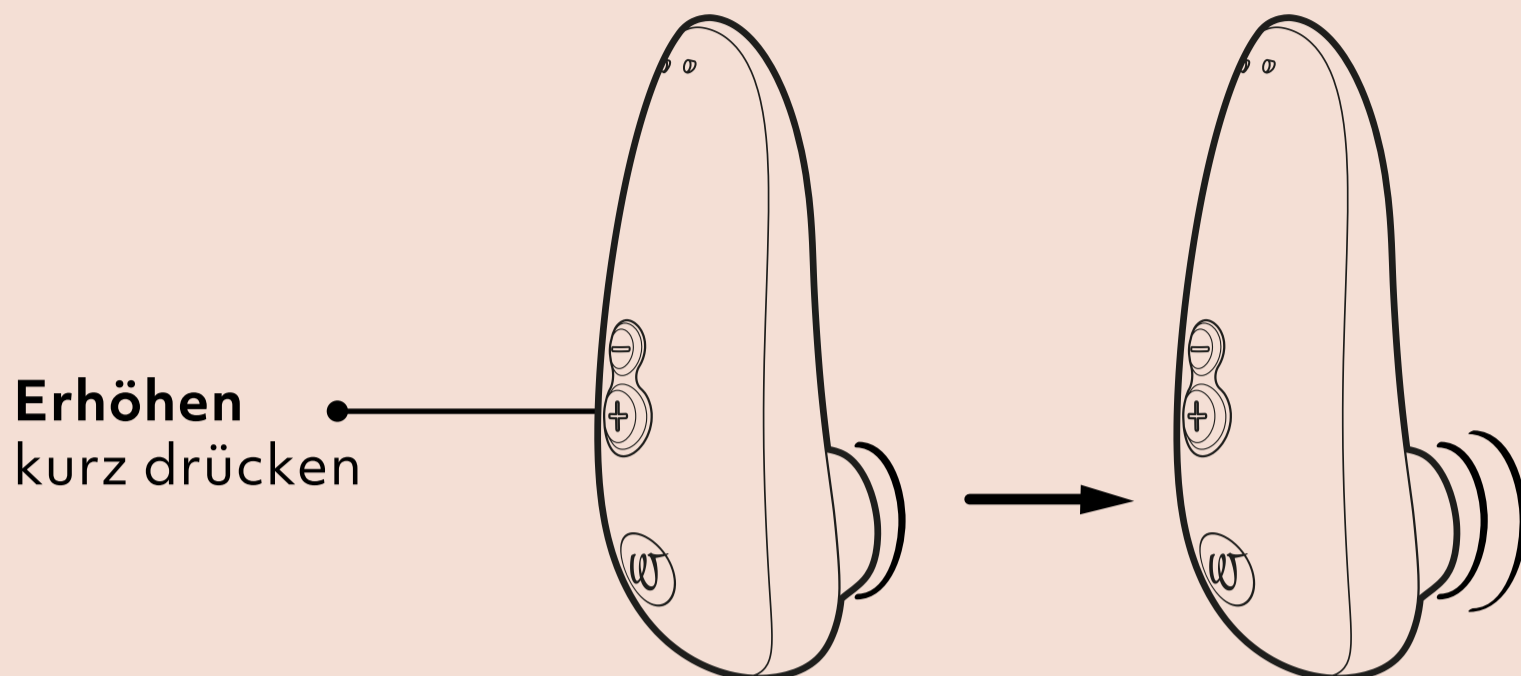

6  Intensity levels

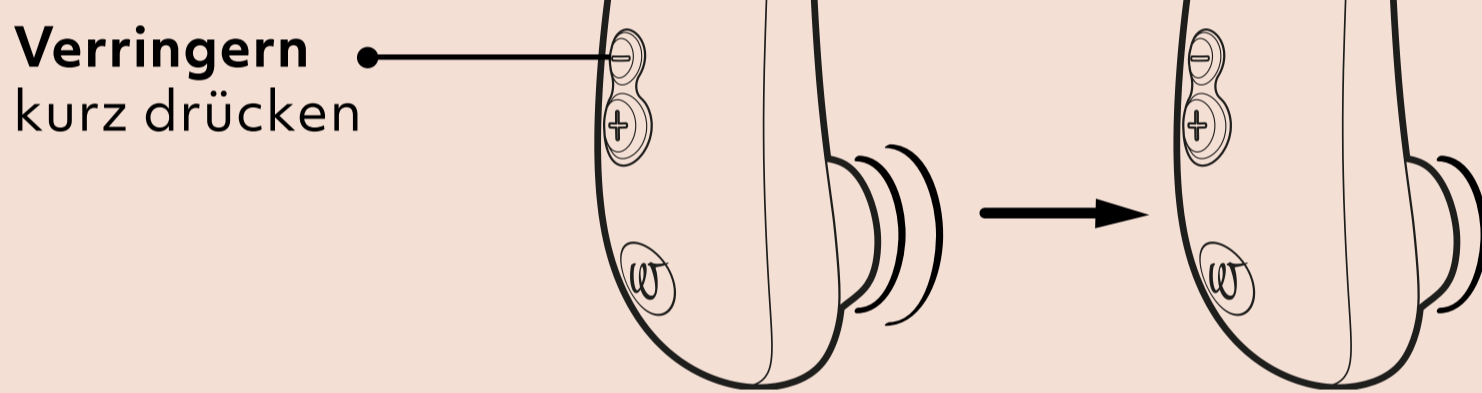

### 4. Ausschalten

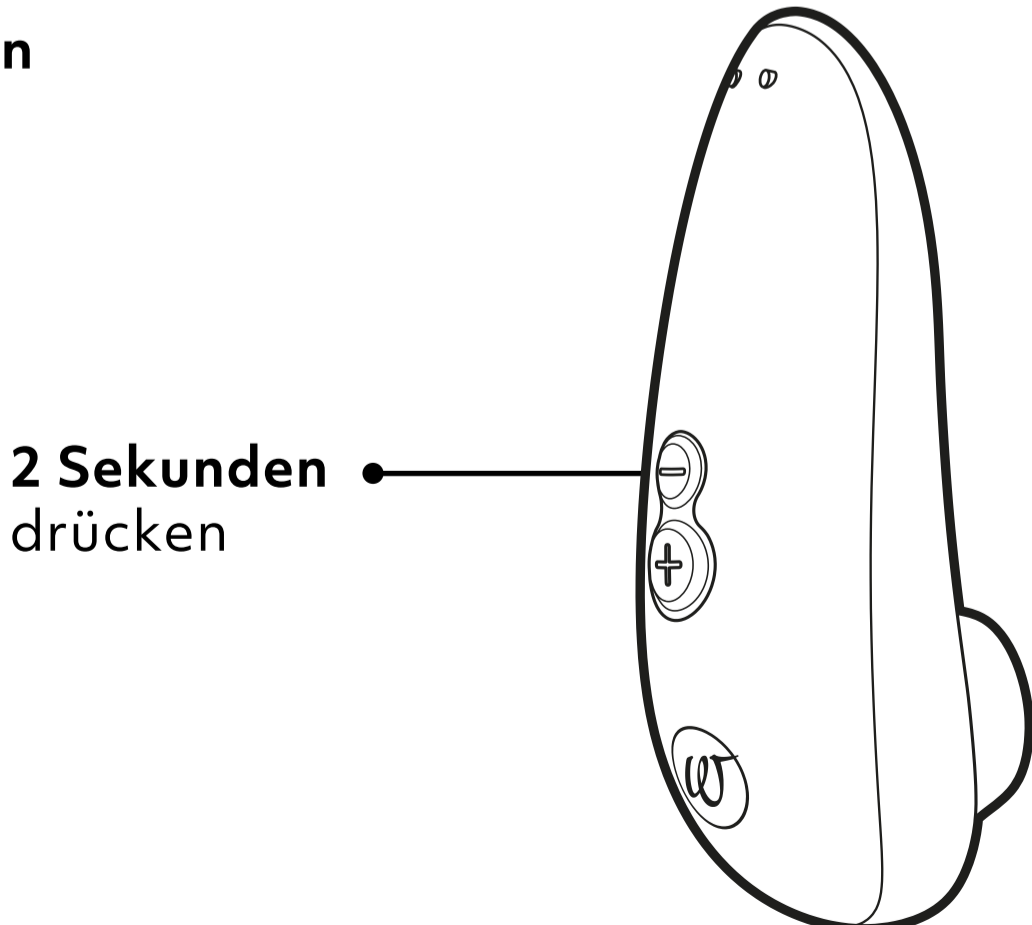

# LADEN

Bitte lade Deinen Womanizer vor dem ersten Benutzen auf. Achte außerdem darauf, Deinen Womanizer regelmäßig aufzuladen, um eine lange Akkulaufzeit zu gewährleisten.

## Laden

über USB-Anschluss

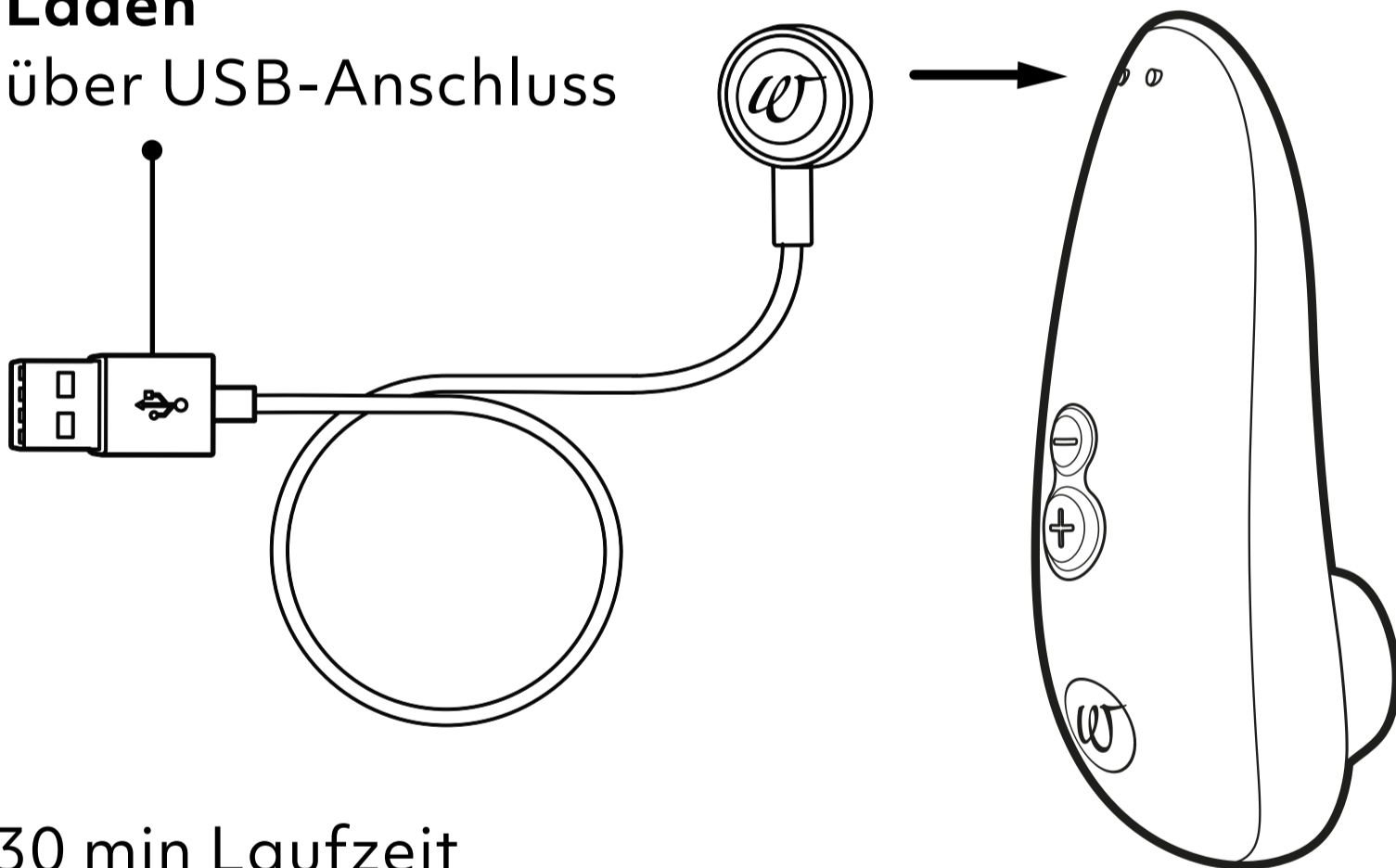

30 min Laufzeit

30 min zum vollständigen Aufladen

# REINIGUNG

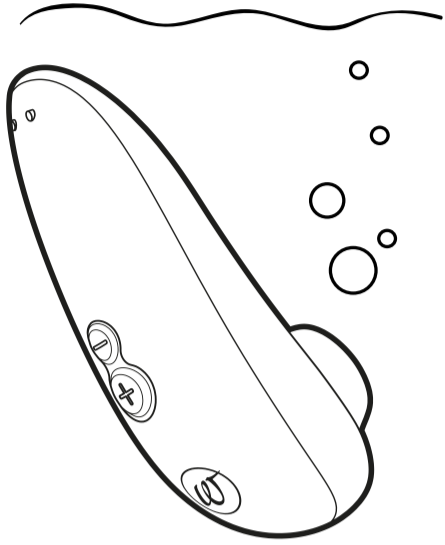

unter Wasser  
waschen

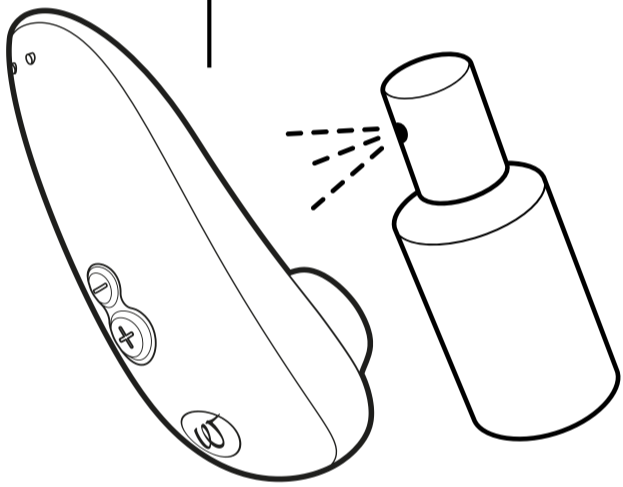

Sextoy-Reiniger  
auftragen.

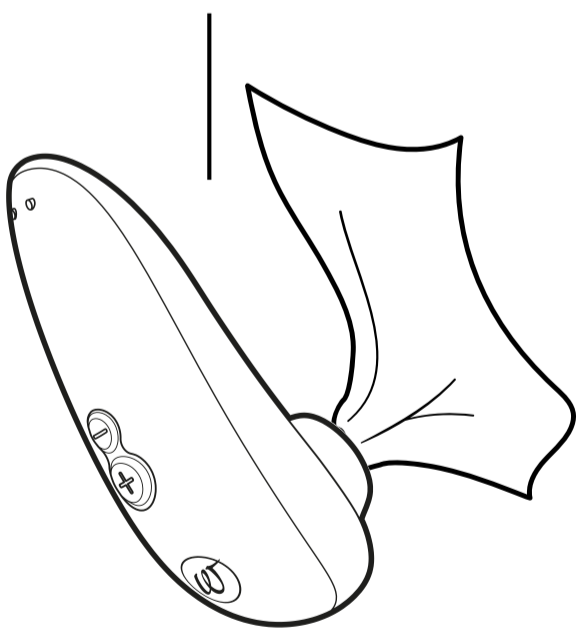

Abtrocknen

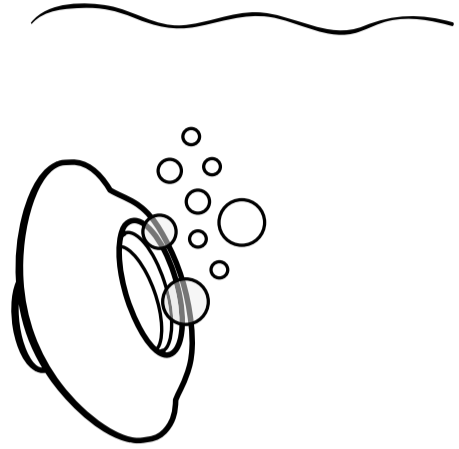

unter Wasser  
waschen

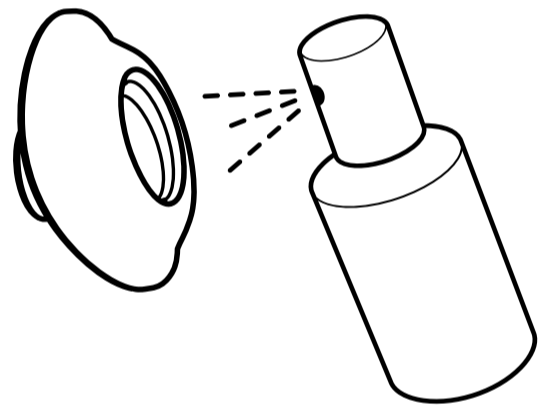

Sextoy-Reiniger  
auftragen.

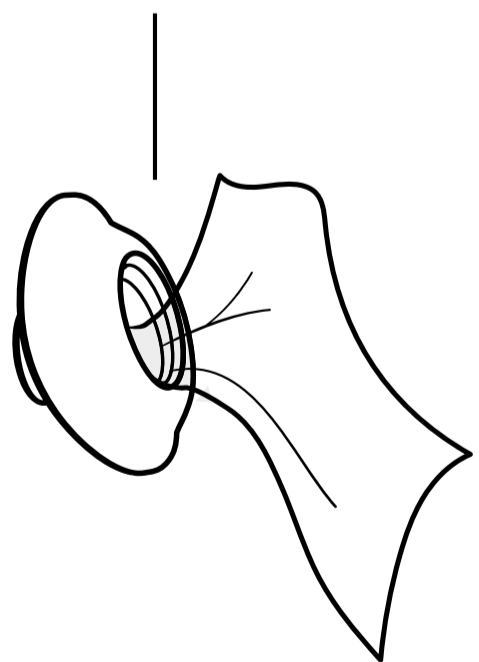

Abtrocknen



Waterproof  
IPX7



# ALLGEMEINE INFORMATIONEN

## WARNHINWEIS

Verwende bei der Nutzung Deines Womanizer keine parfümierten, alkoholhaltigen oder silikonbasierten Gleitgele oder Massageöle, um Schäden am Gerät zu vermeiden.

Reinige Deinen Womanizer vor dem ersten Gebrauch sowie nach jedem Gebrauch gründlich, um das Infektionsrisiko zu verringern.

## KUNDENSERVICE

Weitere Informationen findest Du auf unserer Website [www.womanizer.com](http://www.womanizer.com), oder Du wendest Dich an [care@womanizer.com](mailto:care@womanizer.com).

## TECHNISCHE DATEN

Modell: WZ15B

Elektrische Leistung: 3,7 V  $\approx$  0,135 A: integrierter Lithium-Ionen-Akku.

5 V  $\approx$  0,75 A: bei Aufladen über USB.

Ladegerät:

USB-Netzadapter (nicht im Lieferumfang enthalten) mit der Nennleistung des Geräts entsprechender Ausgangsleistung. Kein Schnellladegerät verwenden.

## LIEFERUMFANG

Womanizer Starlet 3, USB-Ladekabel, Kurzanleitung, Sicherheitshinweise.

## AUFBEWAHRUNG

An einem sicheren, trockenen Ort ohne direkte Sonneneinstrahlung aufbewahren.

## GEWÄHRLEISTUNG UND FREIWILLIGE HERSTELLERGARANTIE

Die WOW TECH EUROPE GMBH bietet ihren Kunden für dieses Produkt zusätzlich zur gesetzlichen Gewährleistung, die dem Verbraucher gegenüber seinem Verkäufer zusteht, eine freiwillige Herstellergarantie.

Die Bedingungen der freiwilligen Herstellergarantie findest Du auf unserer Website im Abschnitt „Garantiebedingungen“.

## ERFÜLLUNG VON NORMEN

Dieses Gerät entspricht allen Normen zur elektromagnetischen Verträglichkeit (EMV). Die Anwendung dieses Produkts ist sicher, sofern es ordnungsgemäß und entsprechend den Anweisungen in dieser Bedienungsanleitung verwendet wird.

## UMWELTSCHUTZ

Als Vertreiber von Elektronikgeräten sind wir gesetzlich verpflichtet, Elektrogeräte und Elektronikaltgeräte unentgeltlich zurückzunehmen. Wir machen Dich zudem darauf aufmerksam, dass Du als Verbraucher gesetzlich dazu verpflichtet bist, gebrauchte Batterien zurückzugeben. Wirf Elektrogeräte und Batterien niemals in den Hausmüll.

Das nachfolgende Symbol, das auch auf unseren Elektronikartikeln angebracht ist, soll Dich hierauf noch einmal ausdrücklich hinweisen.

## DISTRIBUTOR

WOW Tech Europe GmbH,  
Friedenstraße 91 / 91 a, 10249 Berlin, Deutschland

WOW Tech Europe GmbH behält sich das Recht vor, technische und gestalterische Änderungen vorzunehmen, die der Verbesserung des Geräts dienen.

Vertrieb in Nordamerika durch WOW TECH Canada Ltd. 1545 Carling Avenue, Suite 401, Ottawa ON, Kanada K1Z 8P9

[www.wowtech.com](http://www.wowtech.com) Designed in Deutschland. Hergestellt in China 2021. Bedienungsanleitung Ausgabe 02.2021. Version 1.

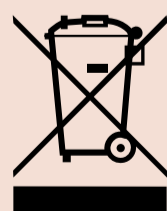

# DU MÖCHTEST NOCH MEHR?

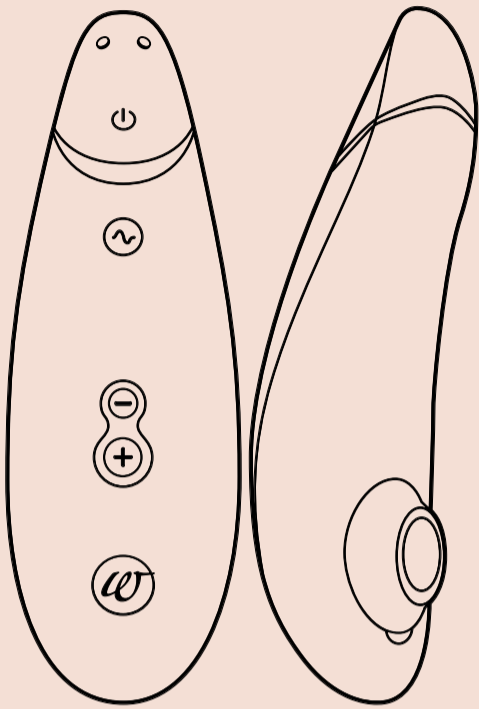

**Pleasure Air  
Technology**



**Smart Silence**

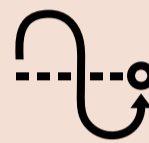

**Autopilot**

**Premium 2**  
Define your luxury

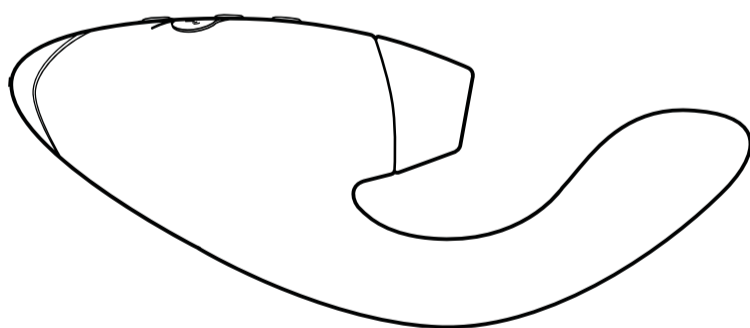

**Pleasure Air  
Technology**



**Vibrator**



**Smart Silence**

**DUO**  
Double your Pleasure



**#IMASTURBATE**

# ¡Hola!

**Gracias por elegir Womanizer!**

Te damos la bienvenida a un mundo de sensualidad que llenará tu vida de placer. Al elegir WOMANIZER, no solo te aseguras orgasmos incomparables, sino también un deseo de placer completamente nuevo.

**Disfruta de tu WOMANIZER, un orgasmo después de otro.**

¡Vamos! ¡Quiérete!



**DESCRIPCIÓN DEL PRODUCTO**

**INDICACIONES DE USO**

**CARGA**

**LIMPIEZA**

**INFORMACIÓN GENERAL**

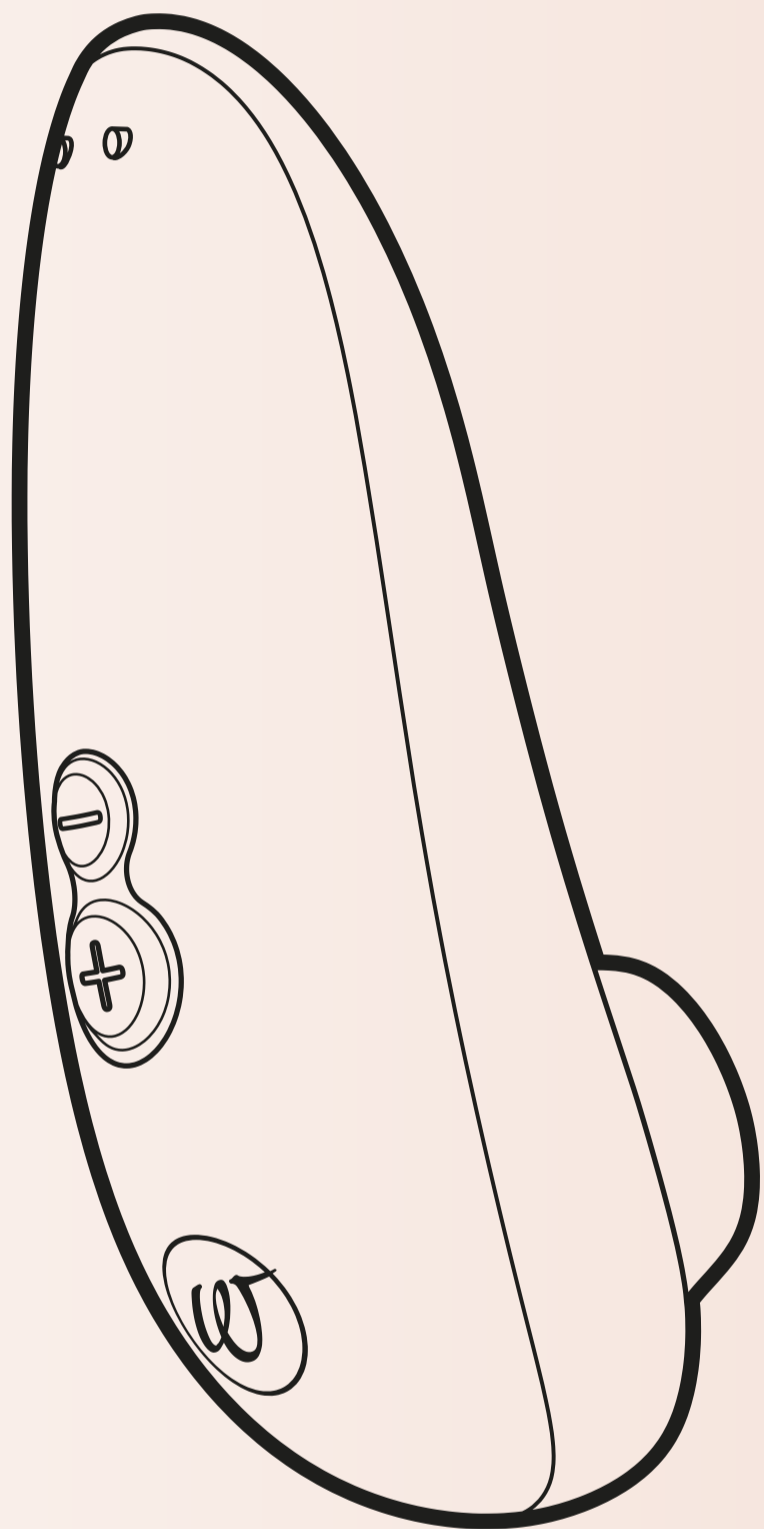

# DESCRIPCIÓN DEL PRODUCTO

**Pines de carga magnéticos**

**Apagado** pulsa durante 2 segundos

**Disminución de la intensidad** pulsa brevemente

**On** pulsa durante 2 segundos

**Aumento de la intensidad** pulsa brevemente

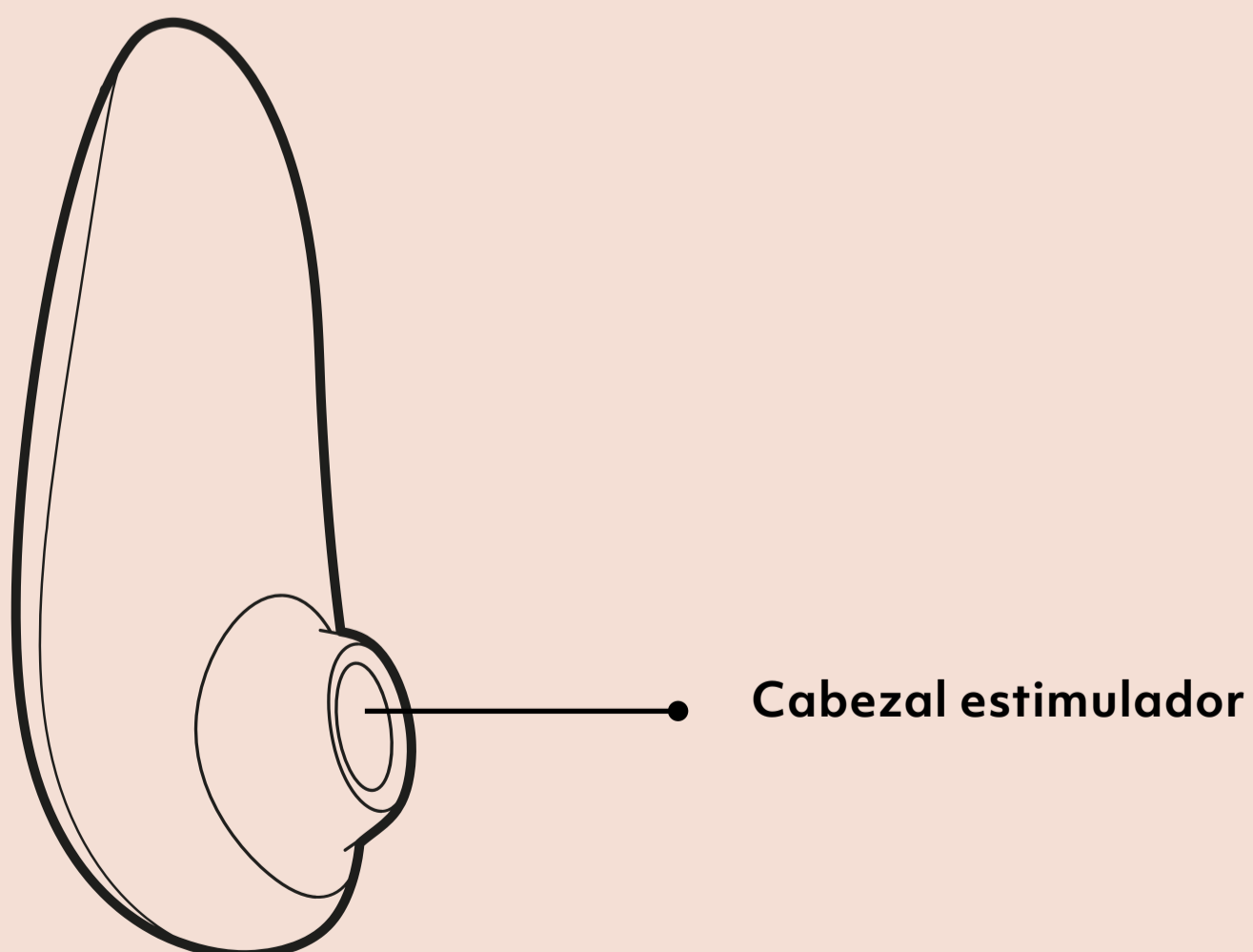
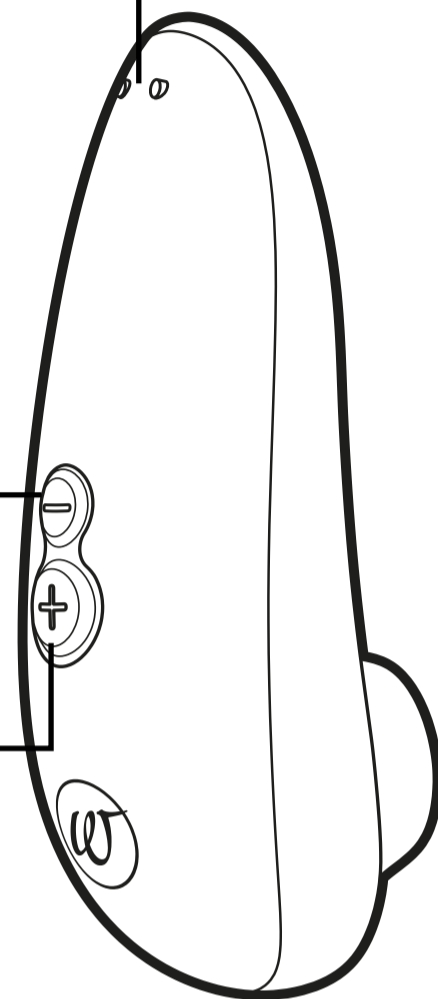

# INDICACIONES DE USO

## 1. Encender

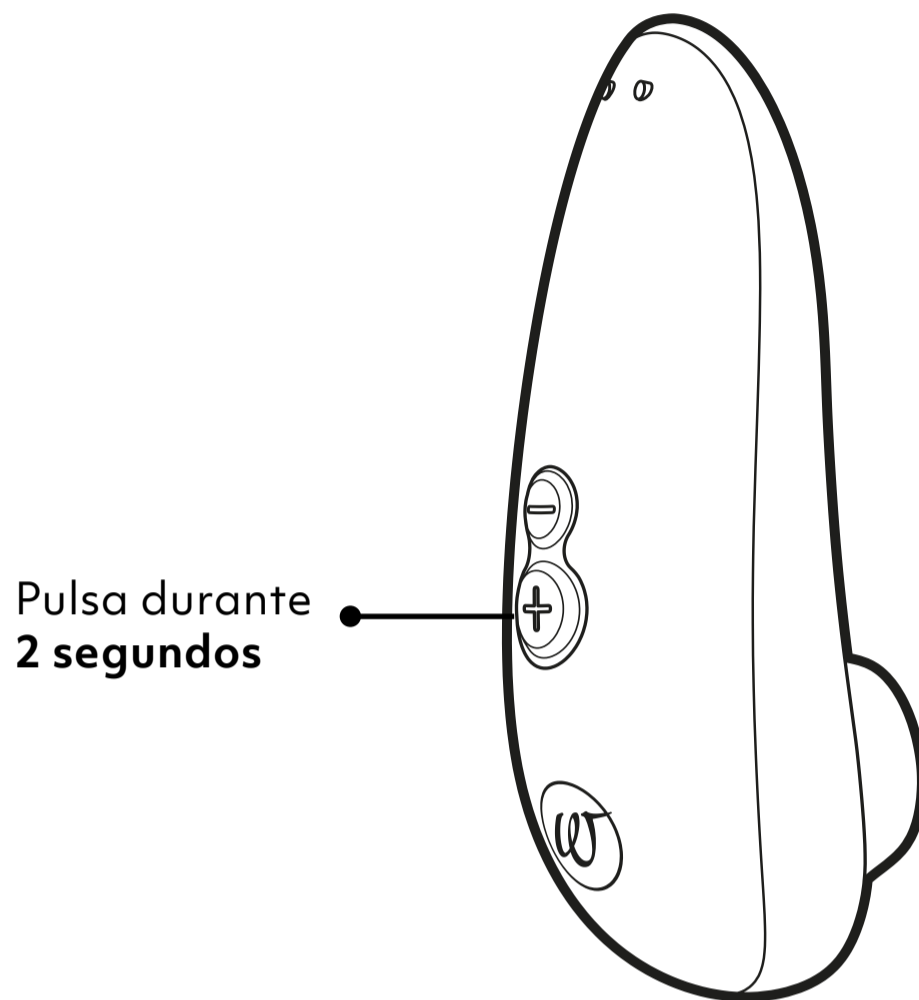

## 2. Uso

Rodea tu clítoris con el cabezal de estimulación y déjate llevar.

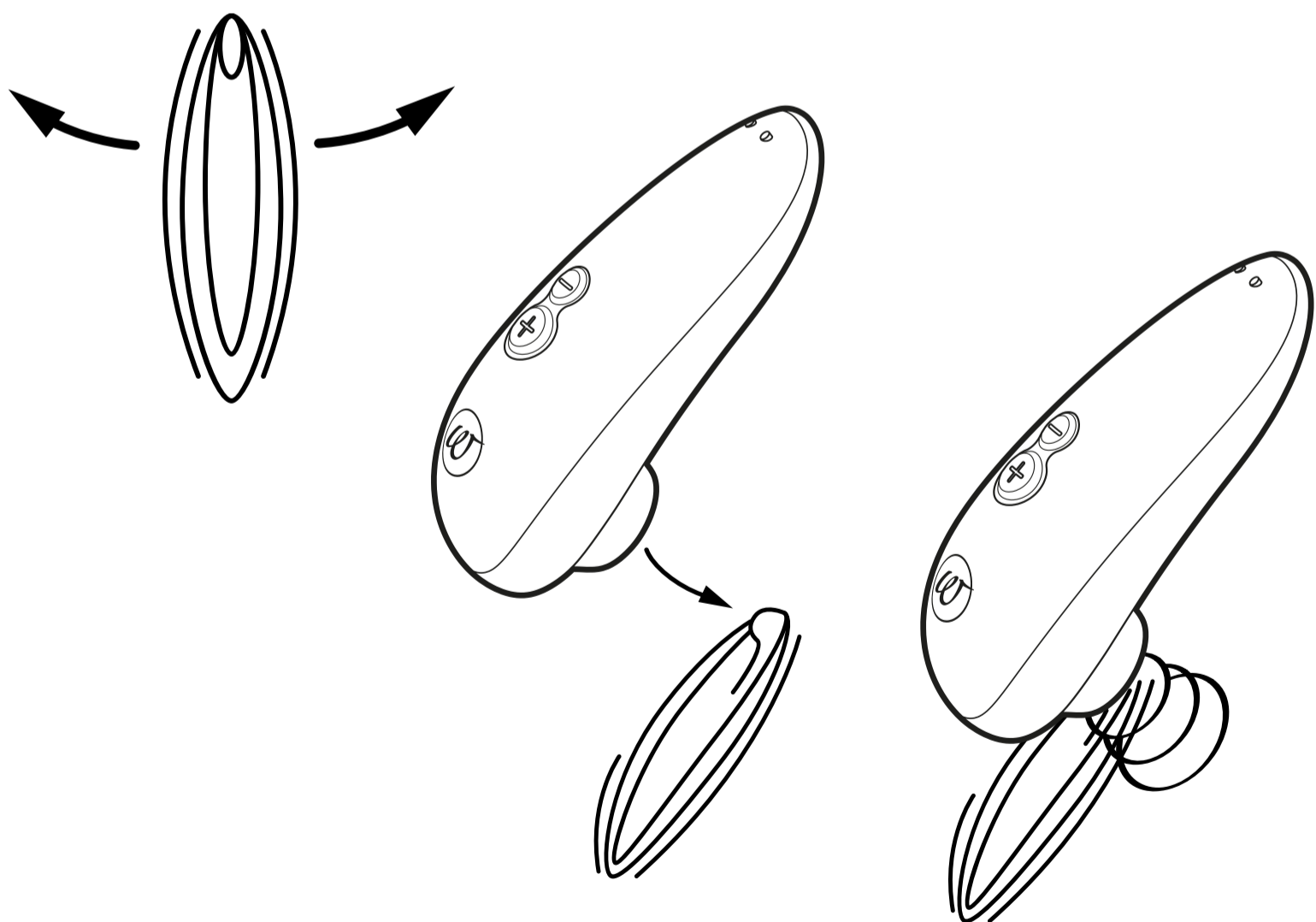



### 3. Cambiar intensidad

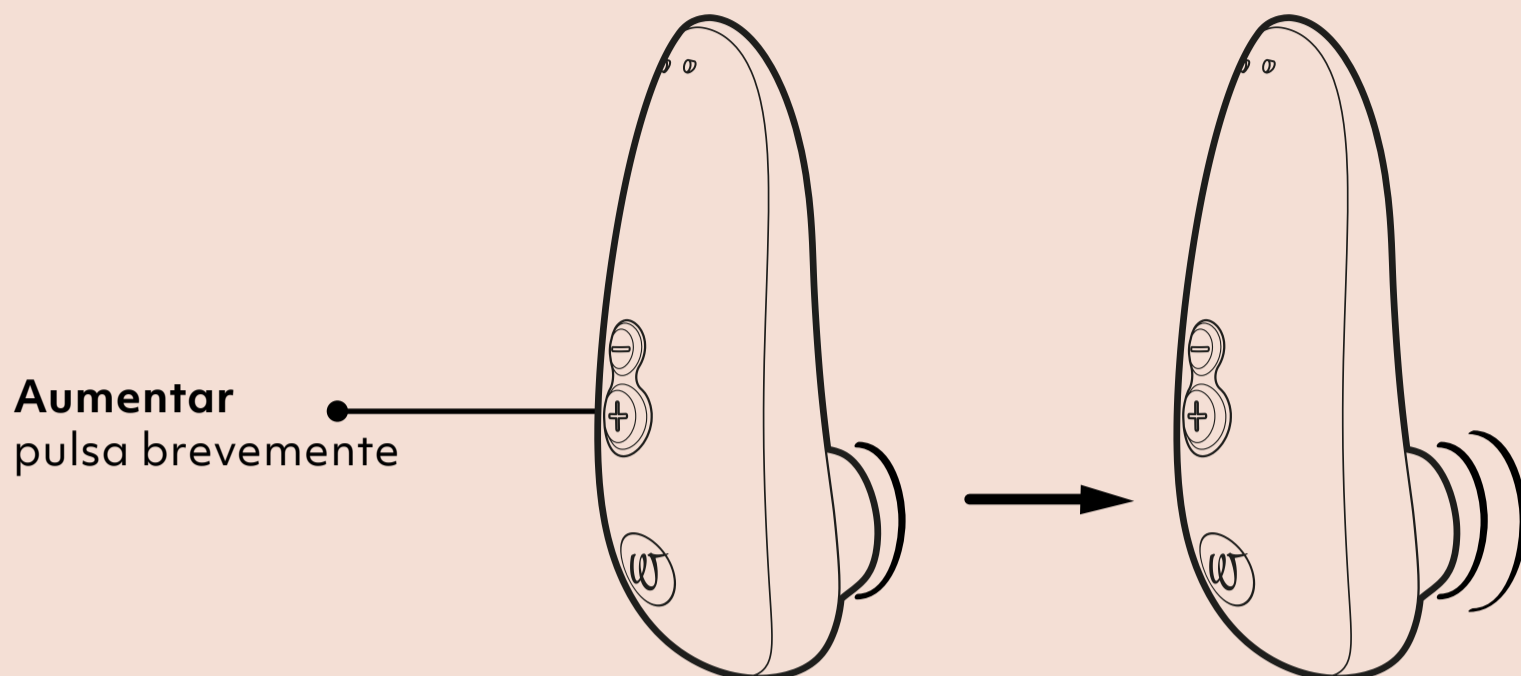

### 6 Niveles de intensidad

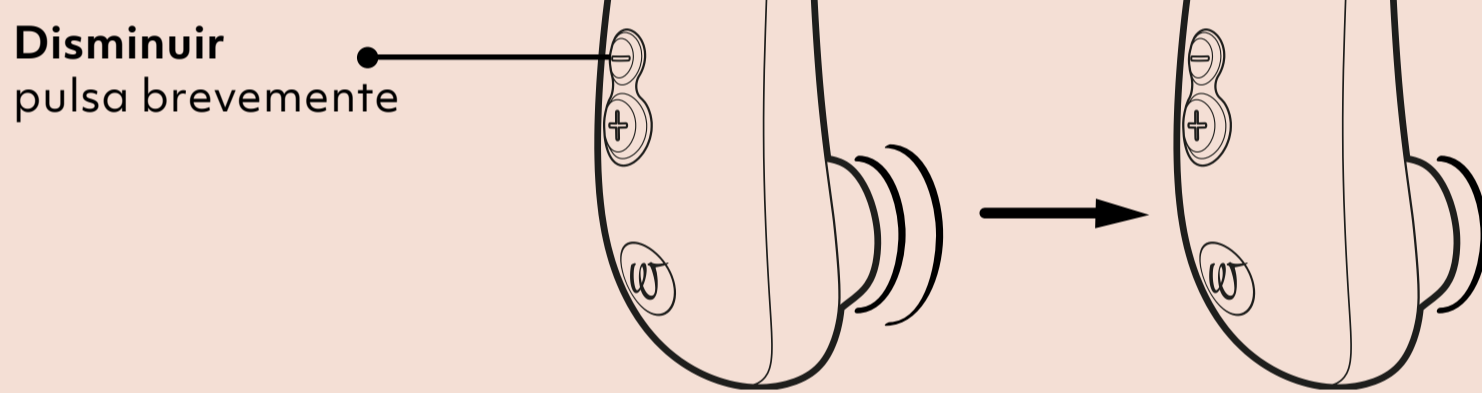

### 4. Apagar

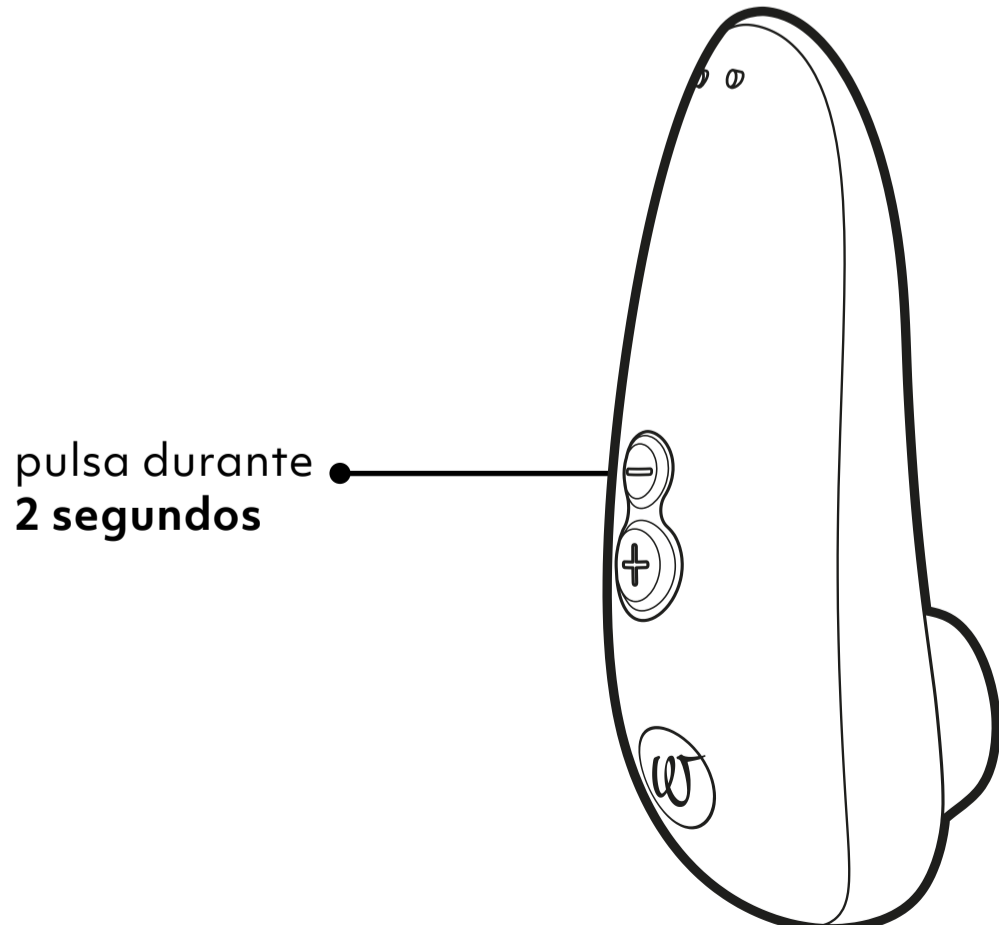

# CARGA

Carga el Womanizer antes de usarlo por primera vez. Recuerda cargar tu Womanizer con regularidad, para asegurar una larga duración de la batería.

**Carga**  
a través del puerto USB

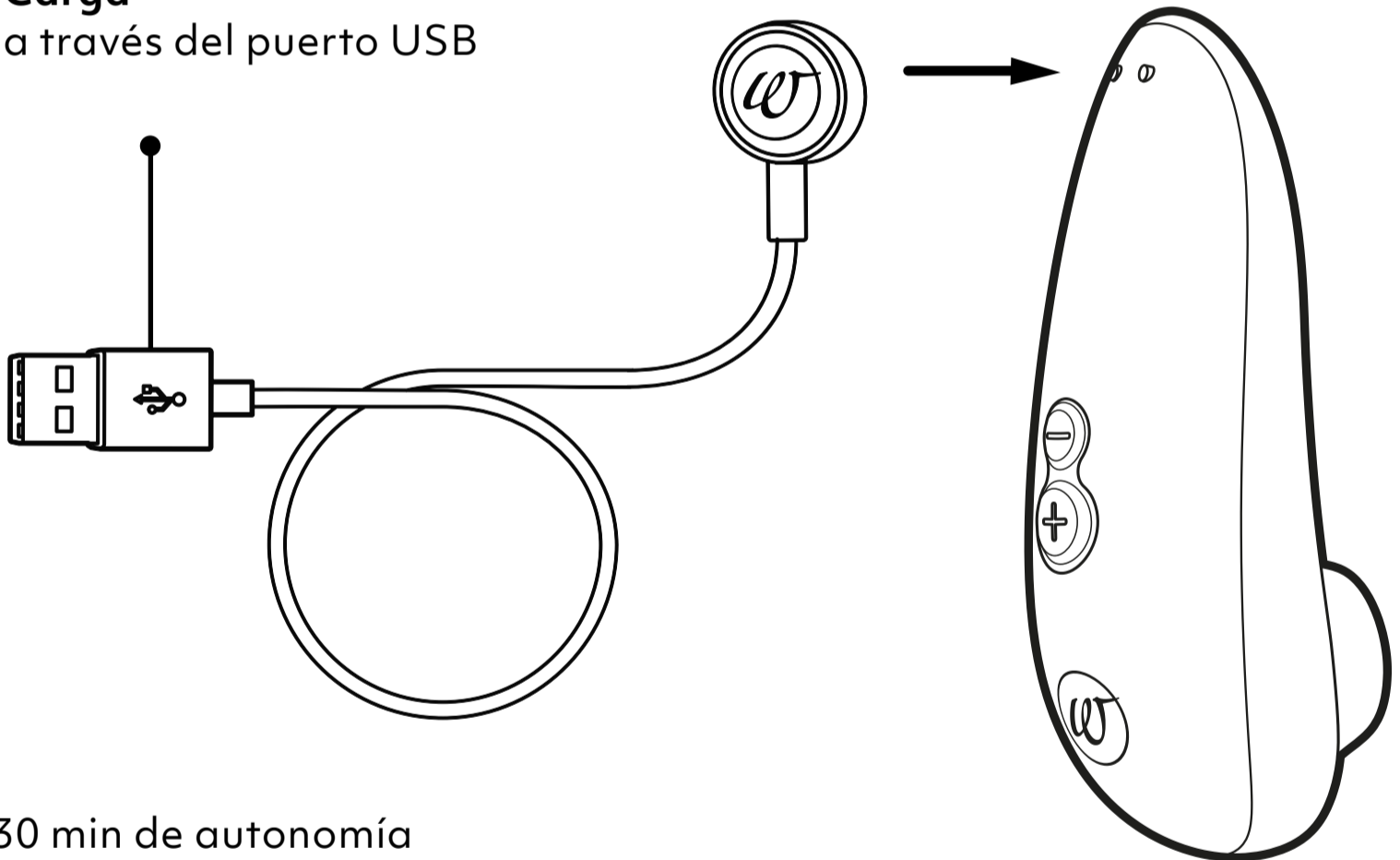

30 min de autonomía  
30 min para carga completa

# LIMPIEZA

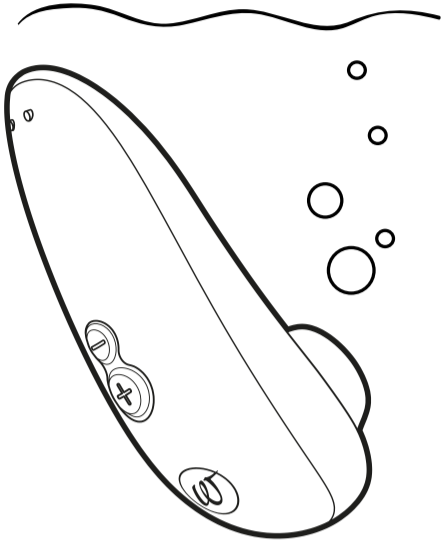

lavar bajo el agua

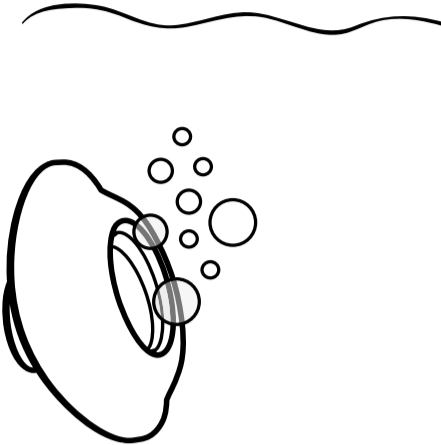

lavar bajo el agua

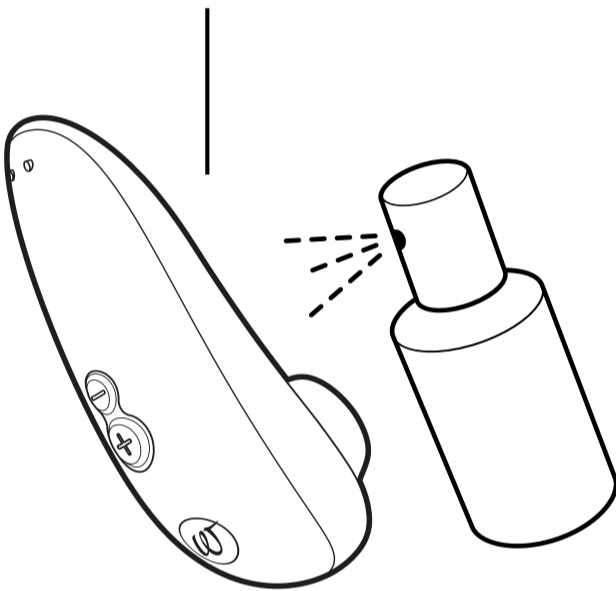

Aplicar un limpiador de juguetes

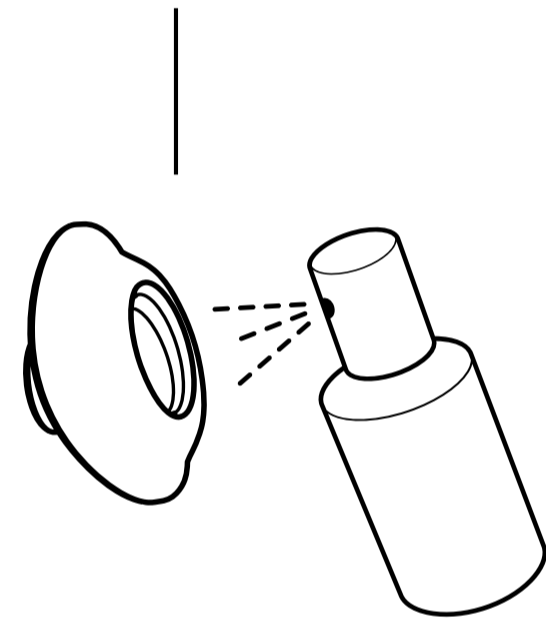

Aplicar un limpiador de juguetes

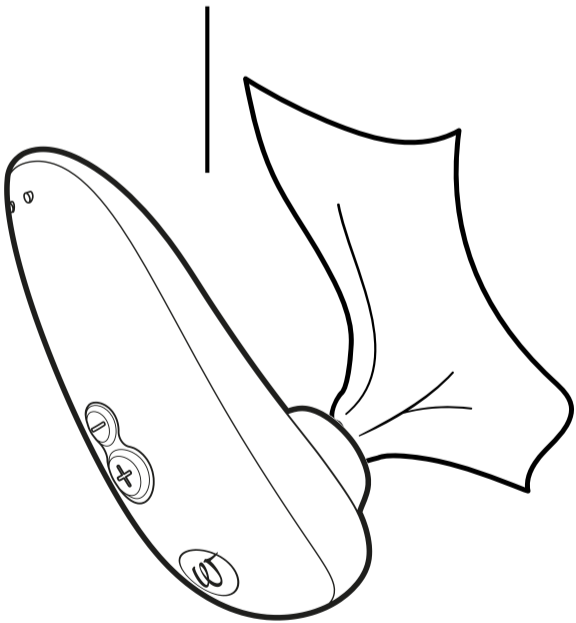

Secar

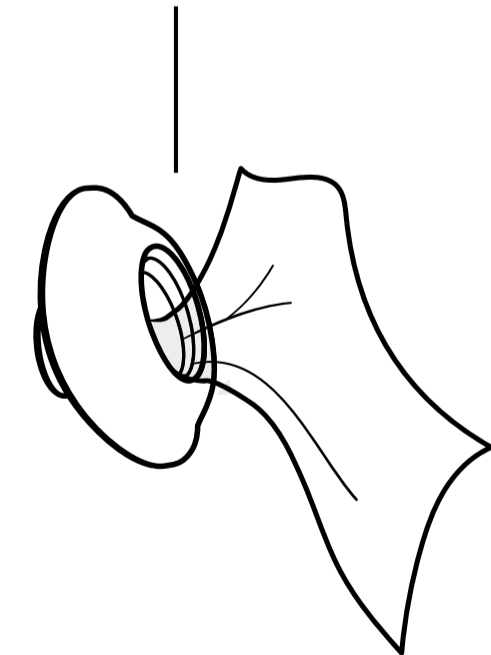

Secar



Waterproof  
IPX7

# INFORMACIÓN GENERAL

## ADVERTENCIA

Para evitar que se dañe, no utilices lubricantes perfumados, a base de alcohol o silicona, geles o aceite de masaje mientras utilice el Womanizer.

Limpia a fondo tu Womanizer antes de utilizarlo por primera vez y después de cada uso para reducir el riesgo de infección.

## ATENCIÓN AL CLIENTE

Visita nuestro sitio web [www.womanizer.com](http://www.womanizer.com) o contacta con nosotros a través de [care@womanizer.com](mailto:care@womanizer.com) para obtener más información.

## ESPECIFICACIONES TÉCNICAS

Modelo: WZ15B

Potencia: 3,7 W = 0,135 A:

Batería integrada Lithium-Ion

5 V = 0,75 A: Cuando se carga usando USB.

Dispositivo de carga:

Adaptador USB/AC (no incluido) con salida de potencia correspondiente a la potencia del producto. No usar un adaptador de carga rápida.

## CONTENIDO DEL PAQUETE

Womanizer Starlet 3, cable de carga USB, guía de inicio rápido, instrucciones de seguridad.

## ALMACENAMIENTO

Guárdalo en un lugar seguro y seco, sin exposición a la luz solar directa.

## GARANTÍA Y GARANTÍA

### VOLUNTARIA

### GARANTÍA DEL FABRICANTE

WOW TECH EUROPE GMBH ofrece a los clientes una garantía voluntaria del cliente para este producto además de la garantía legal a la que tienen derecho los consumidores con respecto a los vendedores.

Las condiciones relativas a la garantía voluntaria del fabricante se encuentran en nuestro sitio web, en el apartado «Condiciones de la garantía».

## CUMPLIMIENTO DE LAS NORMAS

Este dispositivo cumple todas las normas relativas a la compatibilidad electromagnética (CEM). El dispositivo es seguro siempre que se utilice correctamente y de acuerdo con las instrucciones de este manual de usuario.

## PROTECCIÓN DEL MEDIOAMBIENTE

En calidad de distribuidor de dispositivos electrónicos, estamos obligados por ley a aceptar la devolución de residuos de dispositivos eléctricos y electrónicos de forma gratuita. Declaramos expresamente que como usuario estás legalmente obligado a devolver las baterías usadas. No tires nunca los dispositivos electrónicos ni las baterías a los residuos domésticos. El símbolo que se muestra a continuación y que también aparece en nuestros artículos electrónicos tiene por objeto recordártelo expresamente.

## DISTRIBUIDOR

WOW Tech Europe GmbH,  
Friedenstrasse 91 / 91 a, 10249 Berlín, Alemania

WOW Tech Europe GmbH se reserva el derecho a realizar cambios técnicos y cambios de diseño que sirvan para mejorar el dispositivo.

Distribuido en Norteamérica por WOW TECH Canada Ltd. 1545 Carling Avenue, Suite 401, Ottawa ON, Canadá K1Z 8P9

[www.wowtech.com](http://www.wowtech.com) Diseñado en Alemania. Fabricado en China en 2021. Manual publicado en febrero de 2021. Versión 1.

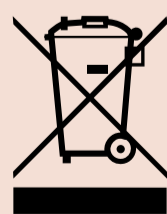

# ¿AÚN QUIERES MÁS?

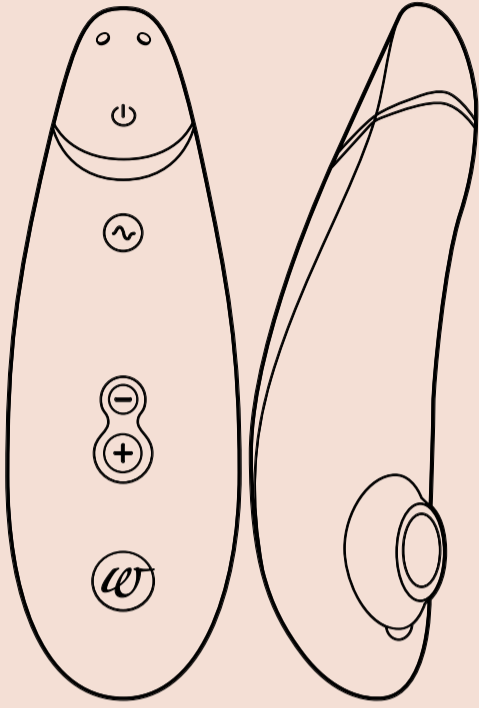

**Pleasure Air  
Technology**



**Smart Silence**

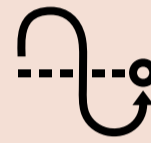

**Autopilot**

**Premium 2**  
Define your luxury

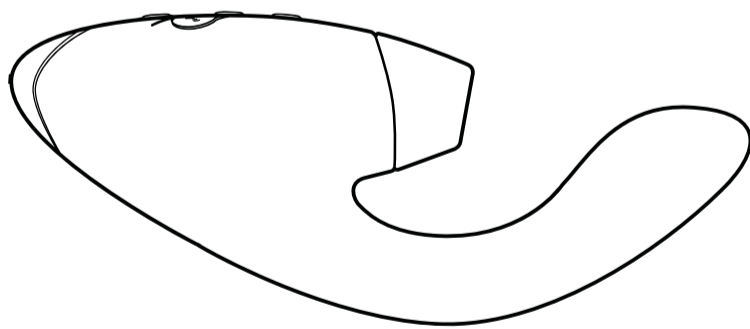

**Pleasure Air  
Technology**



**Vibrator**

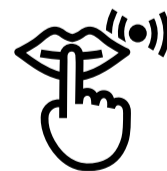

**Smart Silence**

**DUO**  
Double your Pleasure



**#IMASTURBATE**

# Hallo!

**Hartelijk dank dat je voor de Womanizer hebt gekozen!**

Welkom in een wereld vol sensuele ervaringen die je leven zullen verrijken. Door je keuze van de WOMANIZER zul je niet alleen ongeëvenaarde orgasmen beleven, maar gaat er een heel nieuwe wereld van genot voor je open.

**Geniet van je WOMANIZER - orgasme na orgasme.**

Ga lekker met jezelf aan de slag!



**PRODUCTOMSCHRIJVING**

**GEBRUIK**

**OPLADEN**

**REINIGEN**

**ALGEMENE INFORMATIE**



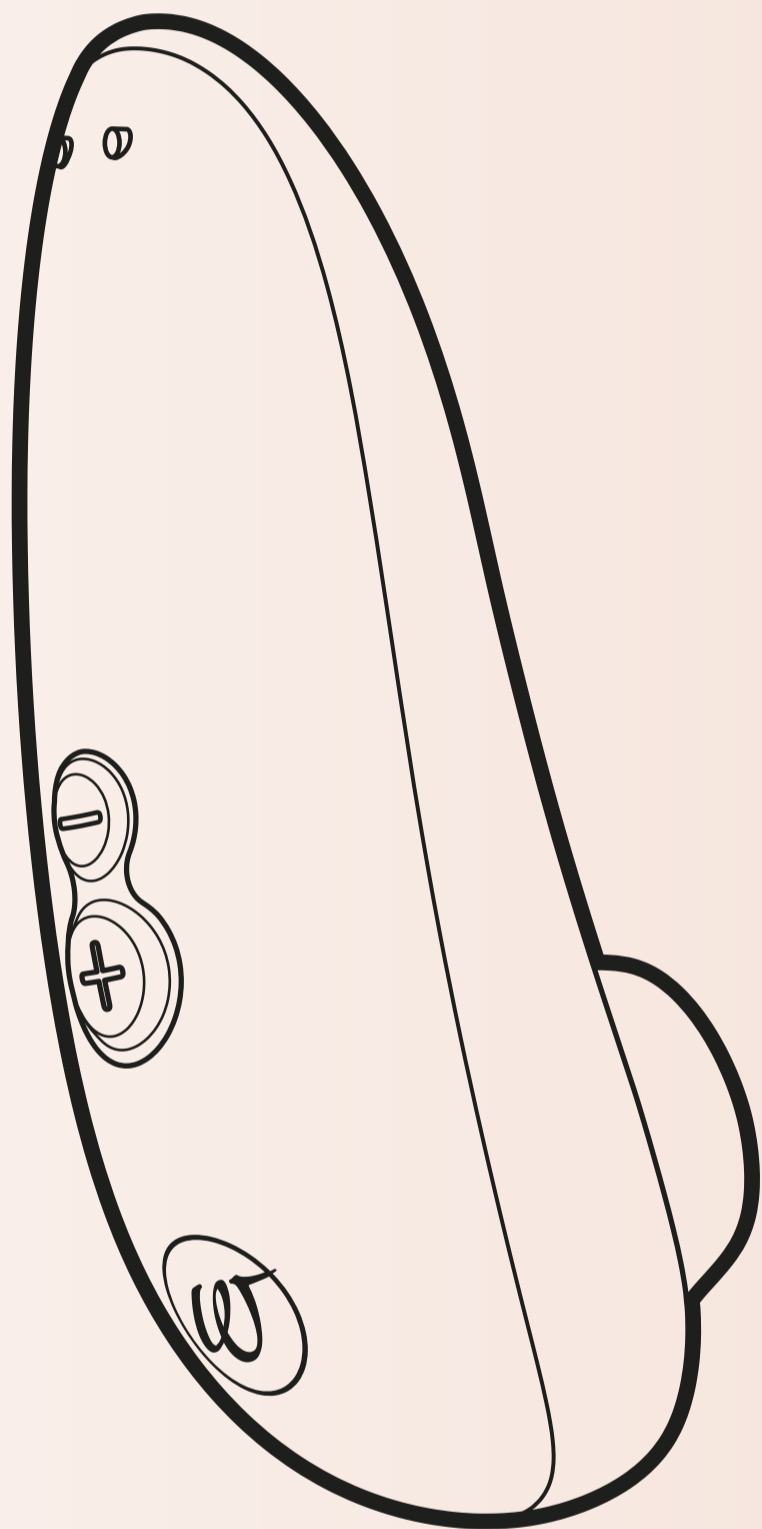

# PRODUCTOMSCHRIJVING

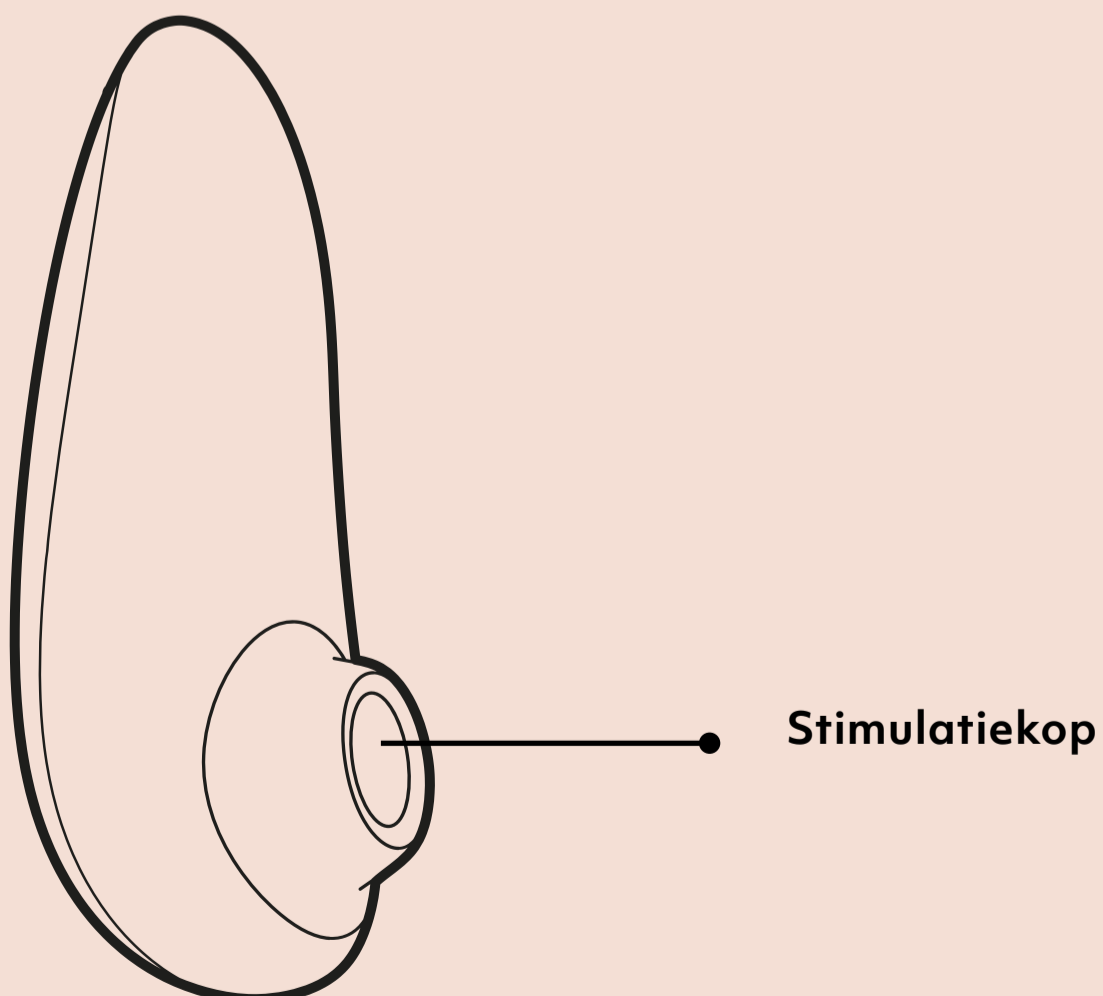
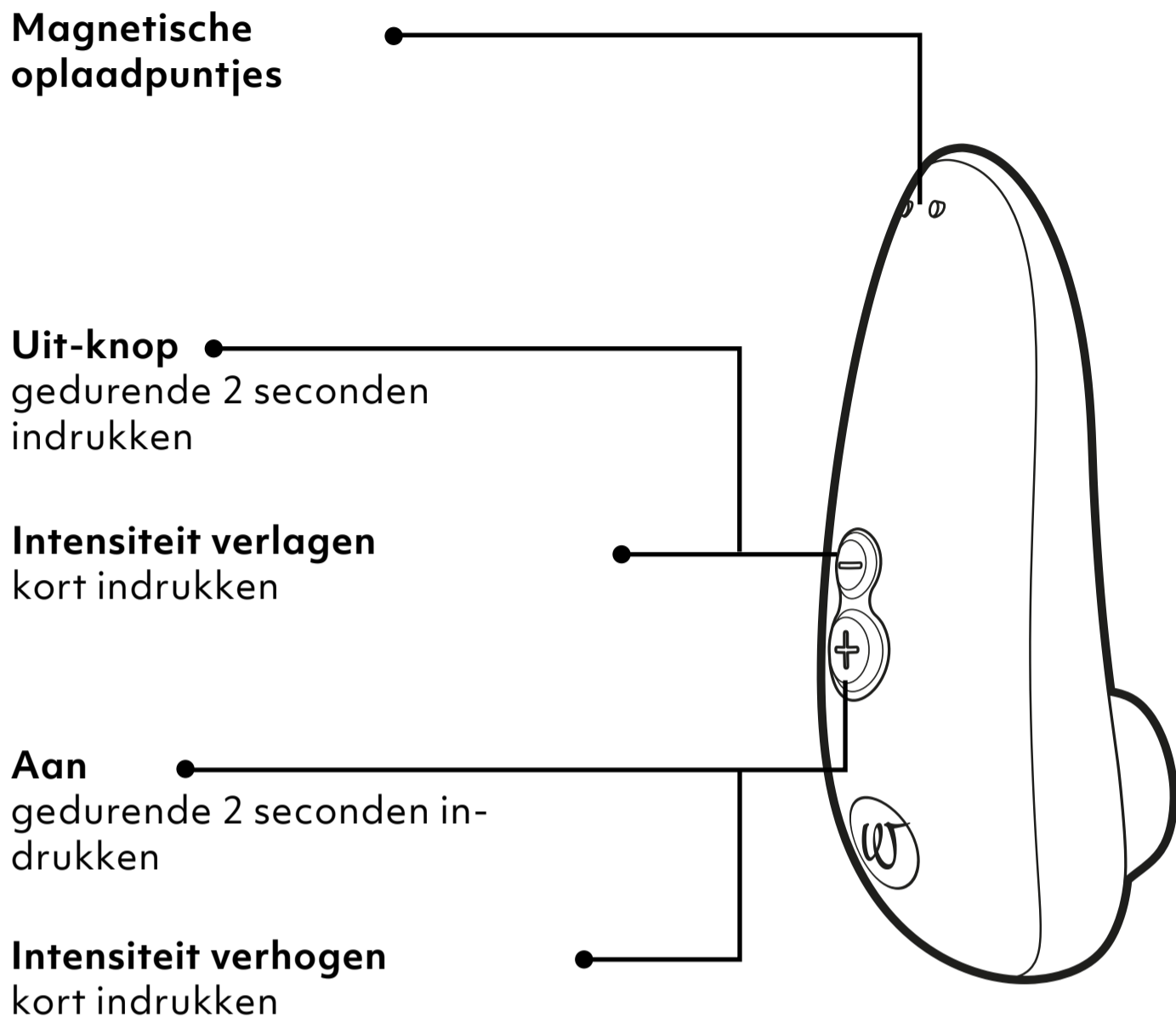

# GEBRUIK

## 1. Inschakelen

Indrukken  
gedurende  
**2 seconden**

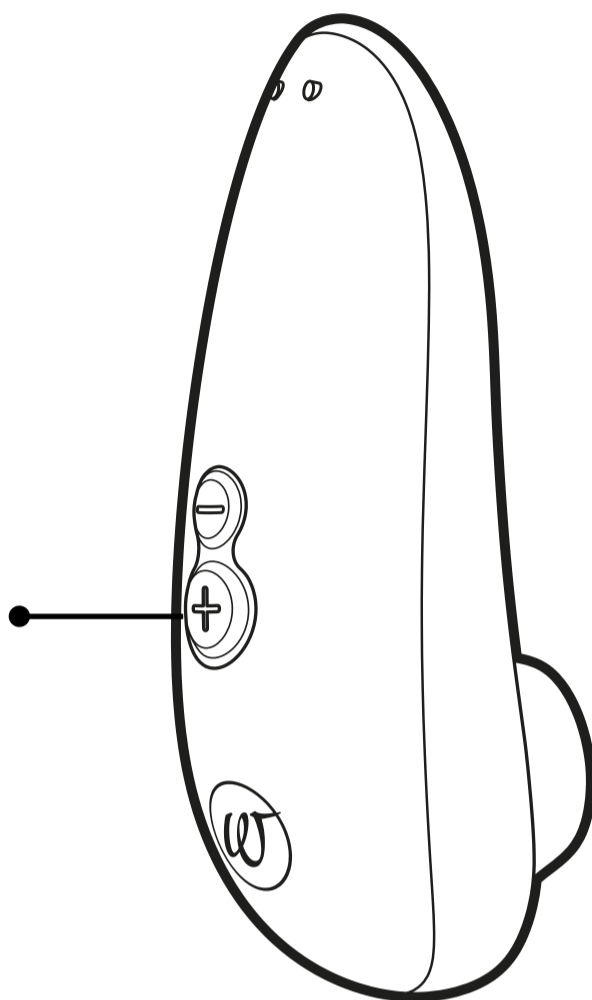

## 2. Gebruik

Plaats de stimulatiekop rondom je clitoris en je reis begint..

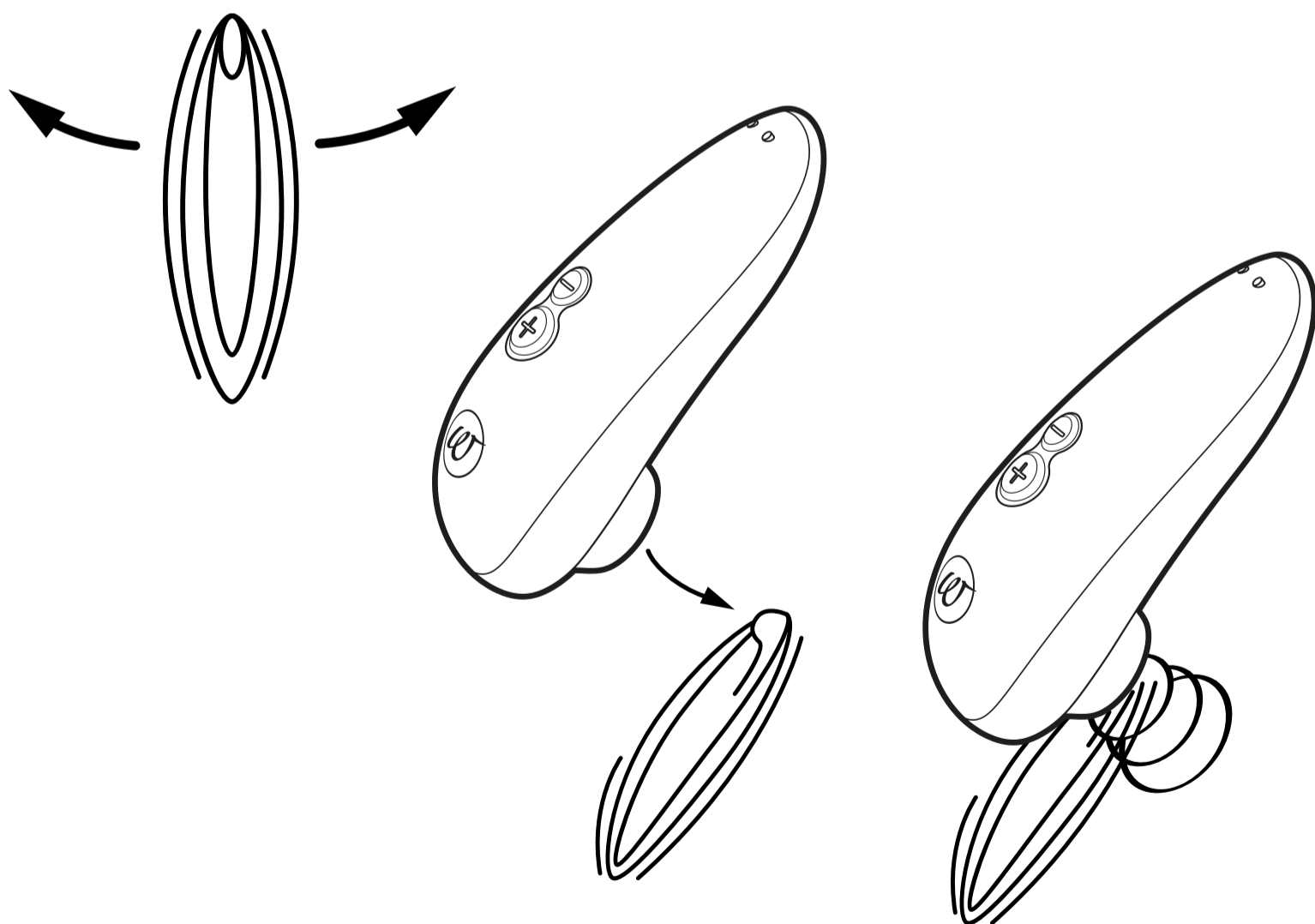

### 3. Intensiteit veranderen

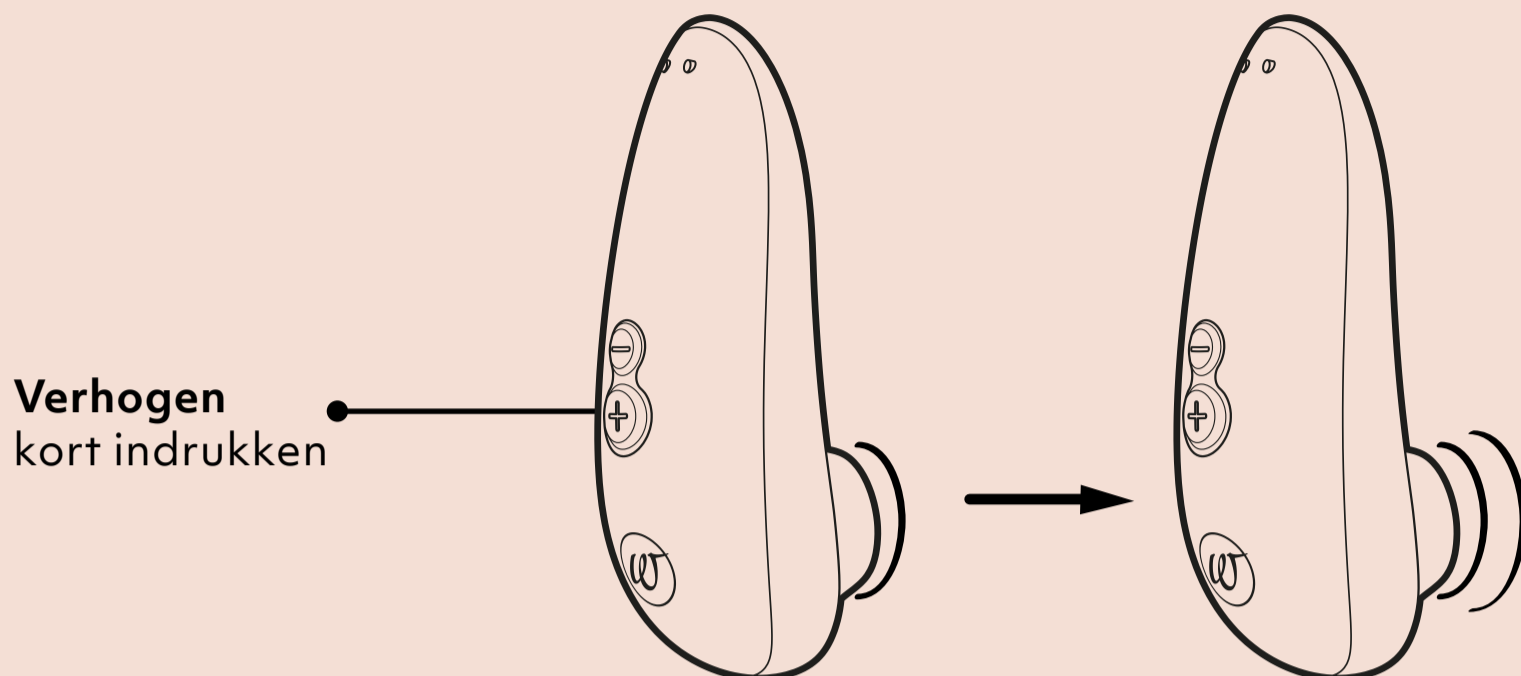

### 6 Intensiteits-niveaus

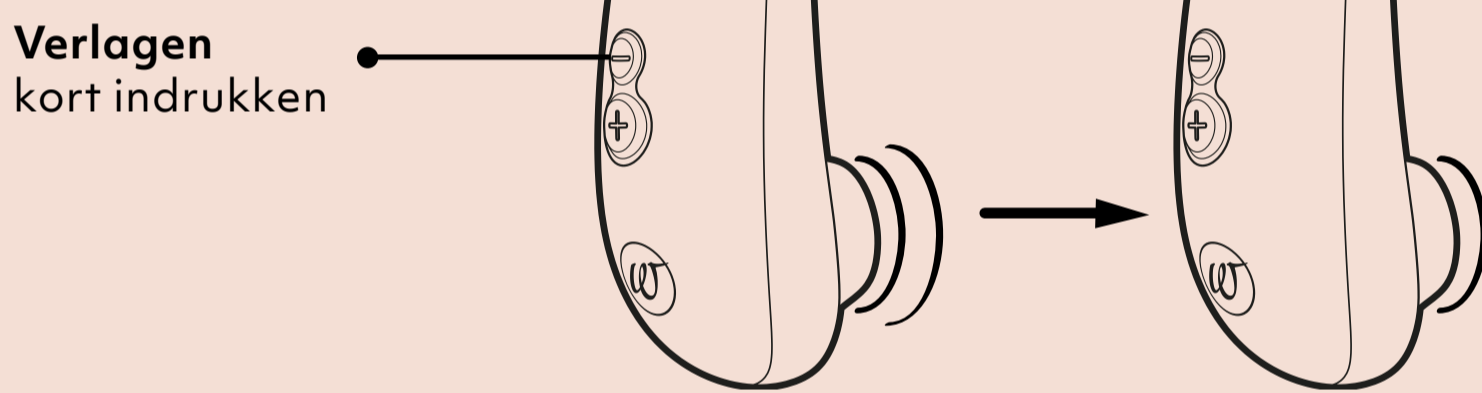

### 4. Uitschakelen

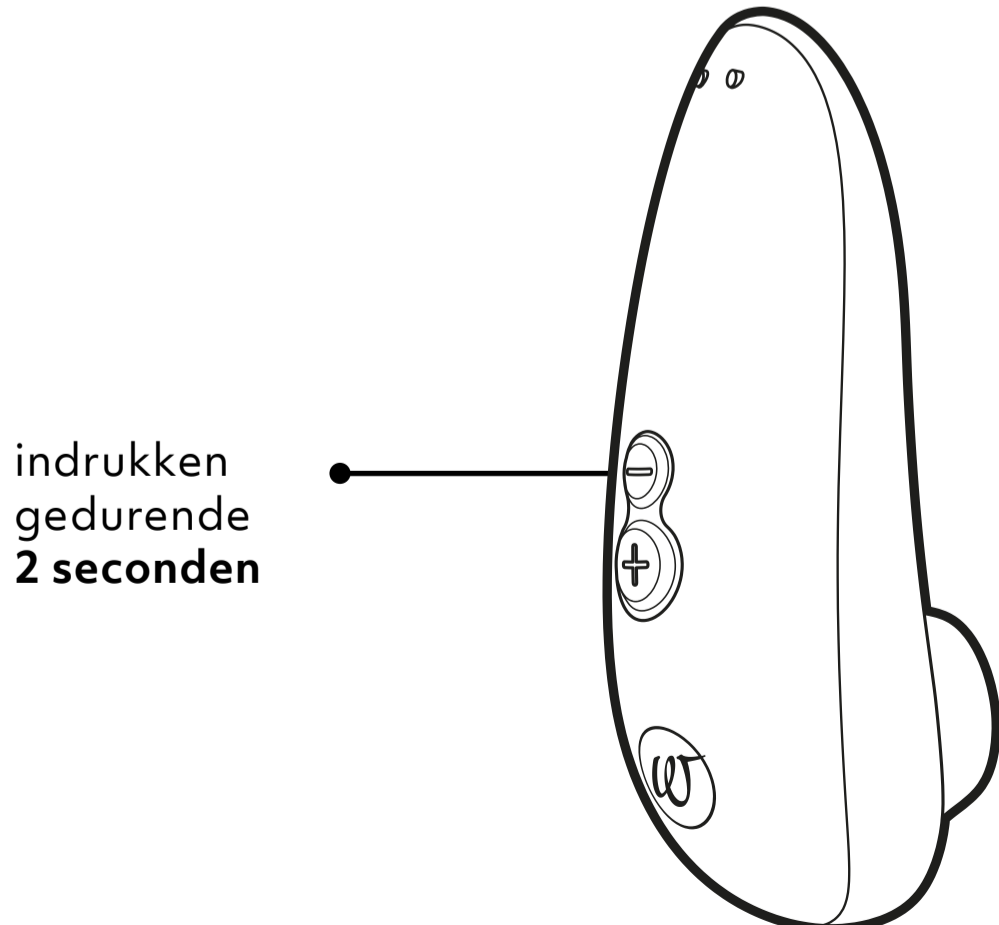

# OPLADEN

Laad je Womanizer voor het eerste gebruik op. Vergeet niet de Womanizer regelmatig op te laden, zodat de batterij lang meegaat.

**Opladen**  
via USB-poort

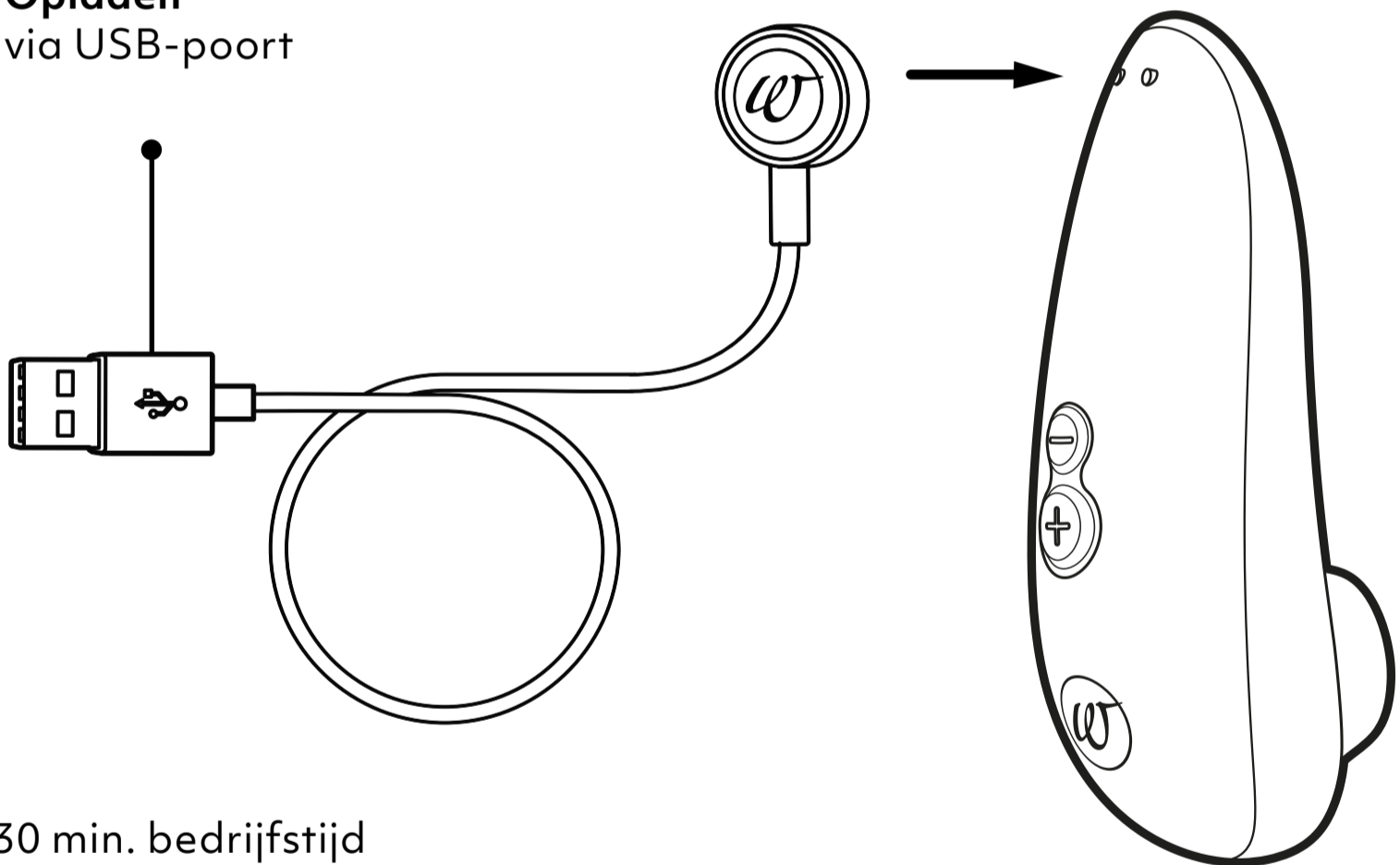

30 min. bedrijfstijd  
30 min. voor volledig opladen

# REINIGEN

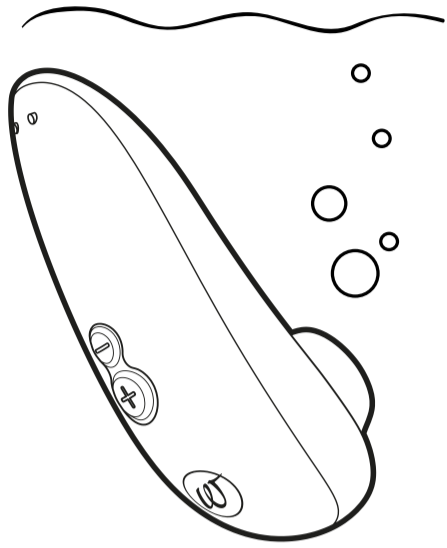

met water  
afspoelen

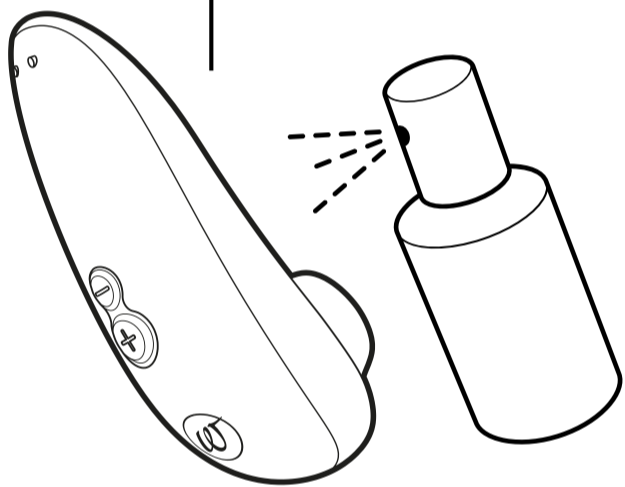

Toy cleaner  
aanbrengen

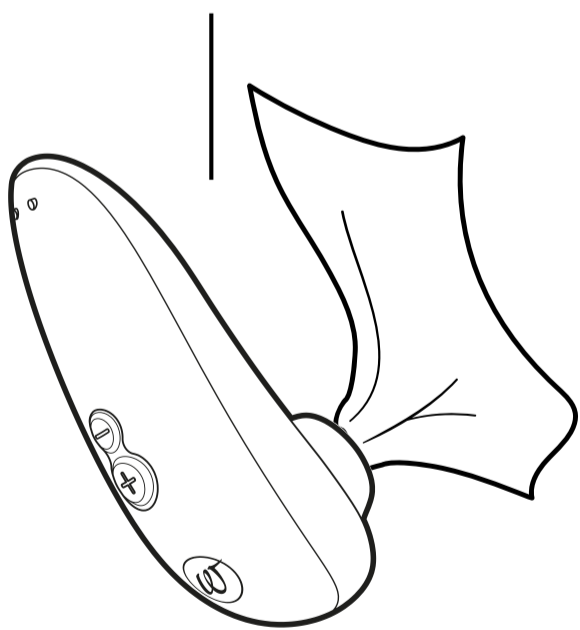

Drogen

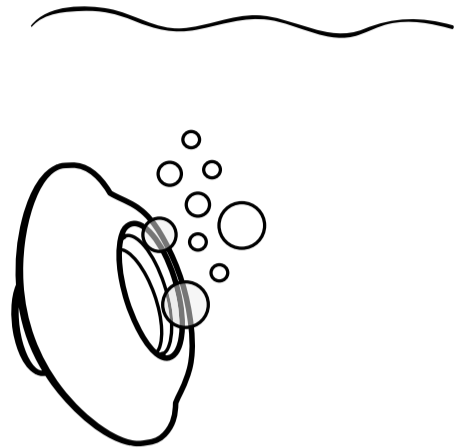

met water  
afspoelen

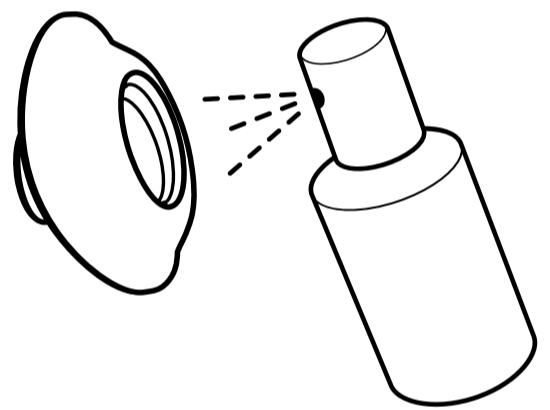

Toy cleaner  
aanbrengen

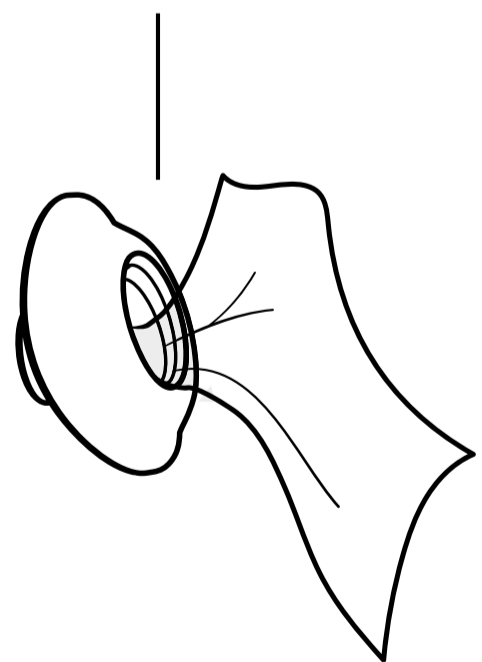

Drogen

+



Waterproof  
IPX7

# ALGEMENE INFORMATIE

## WAARSCHUWING

Gebruik samen met de Womanizer geen glijmiddel of massageolie met parfum of op alcohol- of siliconebasis om beschadiging te voorkomen. Reinig de Womanizer voor het eerste gebruik grondig. Doe dat ook na elk gebruik om de kans op infectie te verminderen.

## KLANTENSERVICE

Kijk voor meer informatie op onze website [www.womanizer.com](http://www.womanizer.com) of neem contact op via [care@womanizer.com](mailto:care@womanizer.com).

## TECHNISCHE SPECIFICATIES

Model: WZ15B

Vermogen: 3,7 W = 0,135 A:

Geïntegreerde heroplaadbare lithium-ion batterij.

5 V = 0,75 A: Bij opladen via USB.

Oplader:

USB AC-adapter (niet meegeleverd) met uitgangsvermogen overeenkomend met productclassificatie. Gebruik niet de snellaadadapter.

## LEVERINGSOMVANG

Womanizer Starlet 3, USB-laadkabel, beknopte handleiding, veiligheidsinstructies.

## OPBERGEN

Bewaar het product op een veilige, droge plaats zonder blootstelling aan direct zonlicht.

## GARANTIE EN VRIJWILLIGE

### FABRIEKSGARANTIE

WOW TECH EUROPE GMBH biedt klanten een vrijwillige fabrieksgarantie voor dit product naast de wettelijke garantie door verkopers waar consumenten recht op hebben.

De voorwaarden met betrekking tot deze vrijwillige fabrieksgarantie vind je op onze website onder „Garantievoorwaarden“.

## COMPLIANCY MET DE NORMEN

Dit apparaat voldoet aan alle normen met betrekking tot elektromagnetische compatibiliteit (EMC). Het apparaat is veilig te gebruiken zolang het correct

wordt gebruikt en volgens de instructies die in deze handleiding worden gegeven.

## BESCHERMING VAN HET MILIEU

Als verkoper van elektronische apparatuur zijn wij er wettelijk toe verplicht om de teruggave van afgedankte elektrische en elektronische apparaten kosteloos te accepteren. Wij wijzen je er uitdrukkelijk op dat jij als gebruiker wettelijk verplicht bent om gebruikte batterijen in te leveren. Gooi elektronische apparaten of batterijen nooit weg via het huishoudelijk afval.

Het onderstaande symbool, dat ook op onze elektronische producten staat aangegeven, is uitdrukkelijk bedoeld om je hieraan te herinneren.

## DISTRIBUTEUR

WOW Tech Europe GmbH,  
Friedenstrasse 91 / 91 a, 10249 Berlin, Duitsland

WOW Tech Europe GmbH behoudt het recht technische wijzigingen en wijzigingen aan het design aan te brengen met als doel het apparaat te verbeteren.

Verkocht in Noord-Amerika door WOW TECH Canada Ltd. 1545 Carling Avenue, Suite 401, Ottawa ON, Canada K1Z 8P9

[www.wowtech.com](http://www.wowtech.com) Ontworpen in Duitsland. Geproduceerd in China in 2021. Handleiding gepubliceerd in 02/2021. Versie 1.

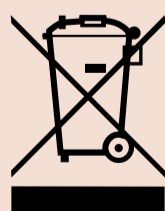

# ZIN IN MEER?

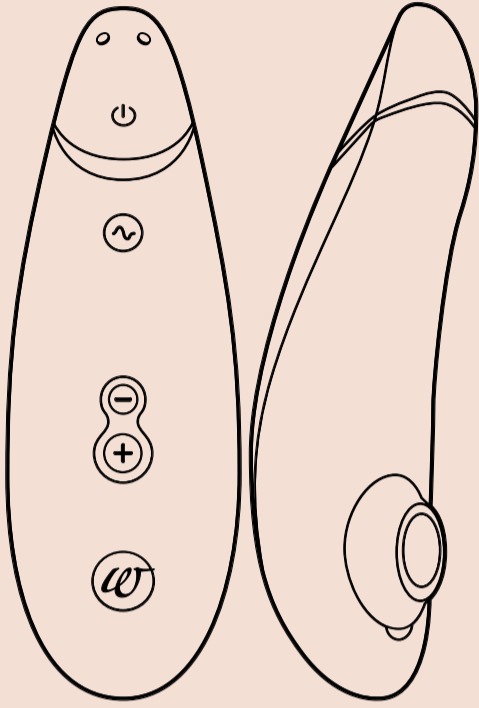

**Pleasure Air  
Technology**



**Smart Silence**

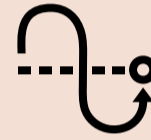

**Autopilot**

**Premium 2**  
Define your luxury

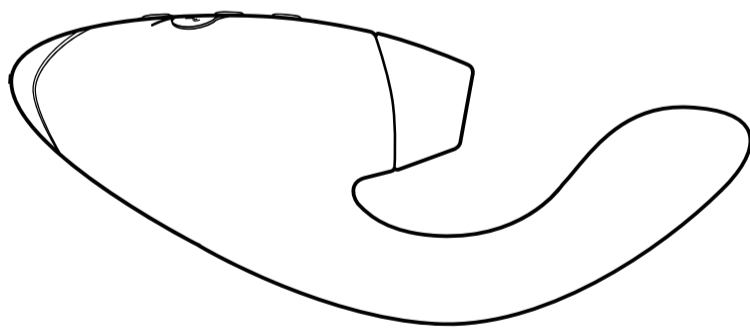

**Pleasure Air  
Technology**



**Vibrator**

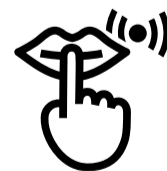

**Smart Silence**

**DUO**  
Double your Pleasure





**#IMASTURBATE**

# Ahoj!

**Děkujeme Vám, že jste si vybrali Womanizer!**

Vítejte ve světě plném smyslových zážitků, které obohatí Váš život. Výběrem produktu WOMANIZER získáte nejen záruku nepřekonatelného orgasmu, ale také zcela nový zážitek z uspokojení.

**Potěšte se s WOMANIZERem – jeden orgasmus za druhým.**

Pomilujte se!



**POPIS PRODUKTU**

**JAK PRODUKT POUŽÍVAT**

**NABÍJENÍ**

**ČIŠTĚNÍ**

**OBECNÉ INFORMACE**

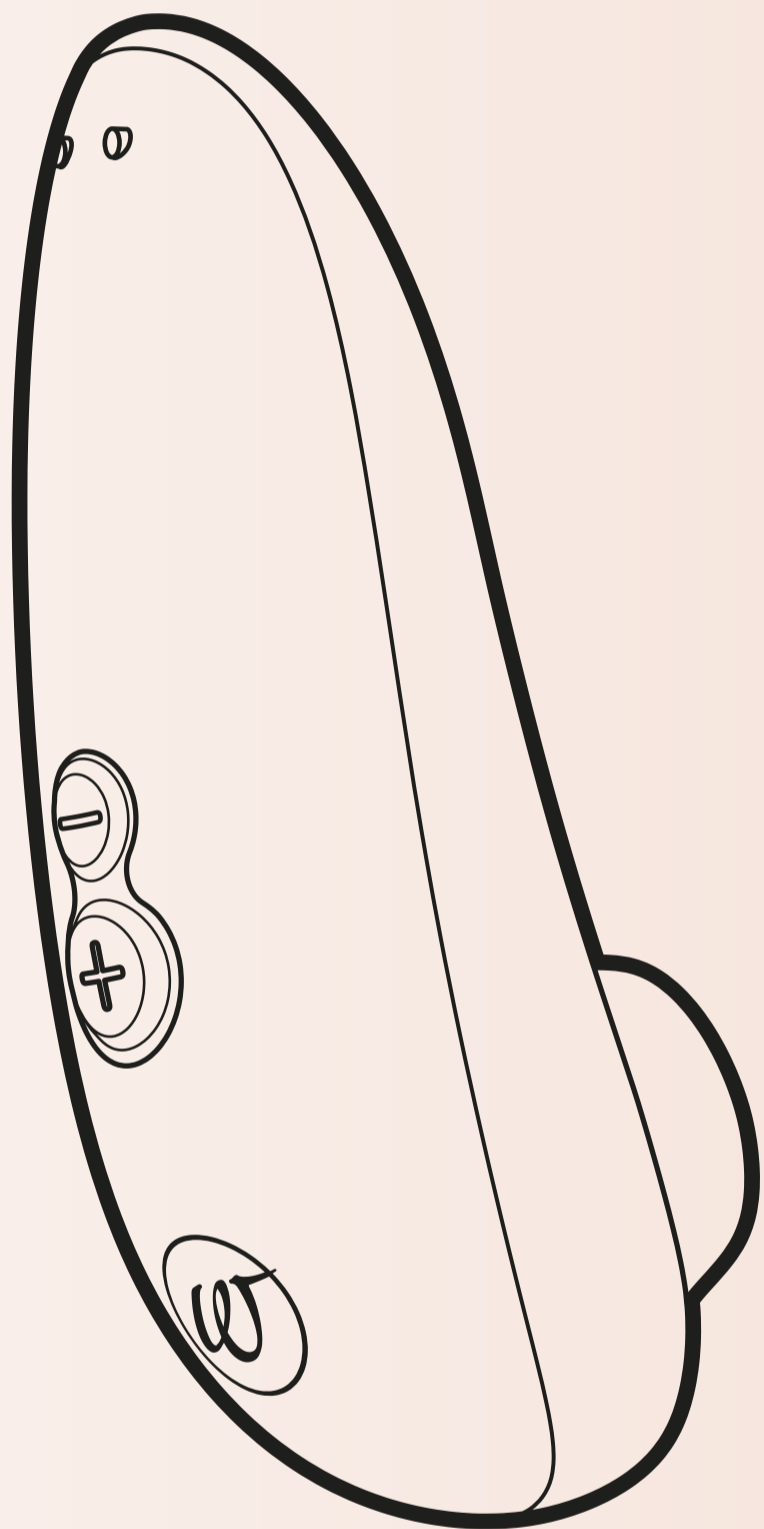

# POPIS PRODUKTU

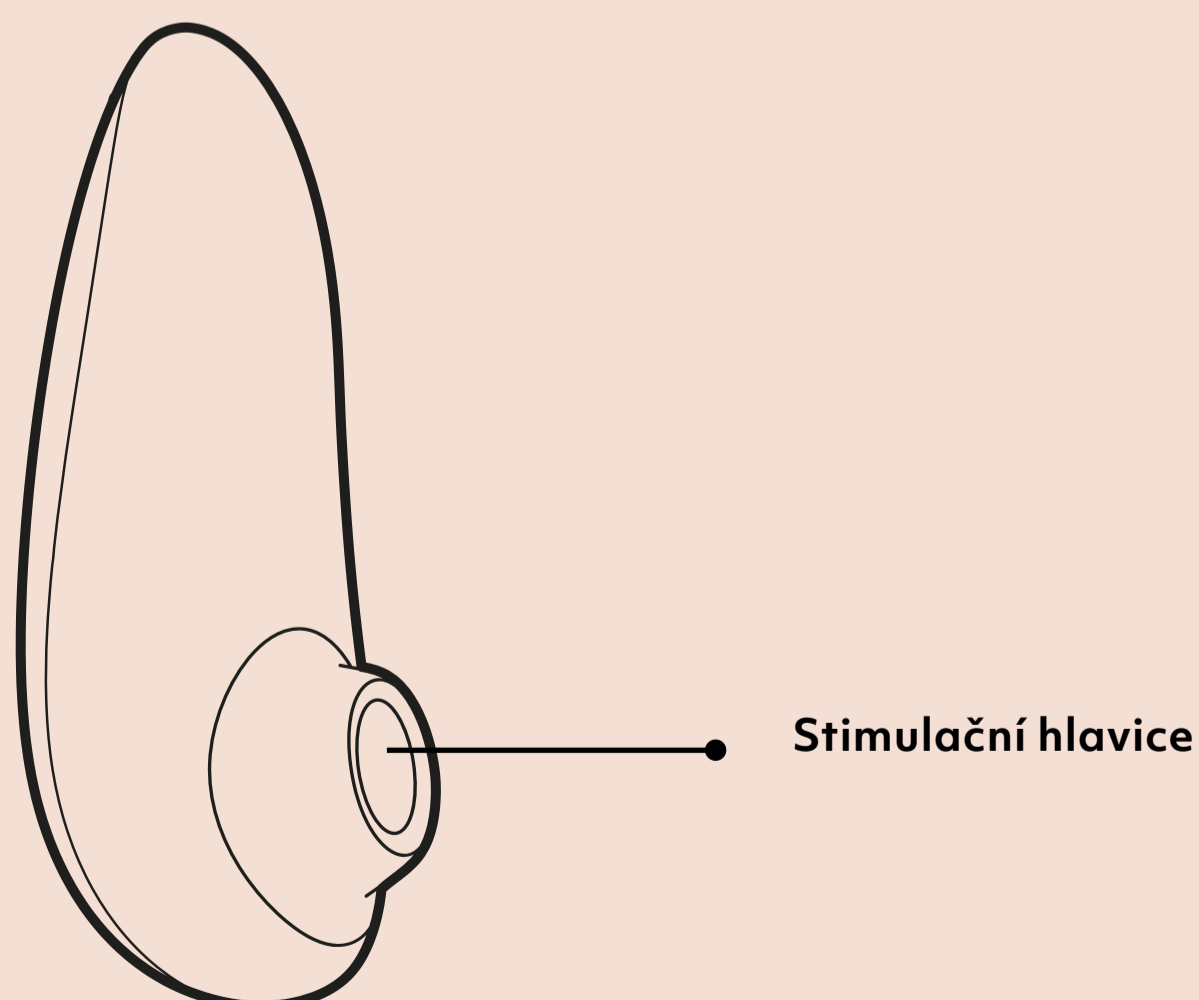
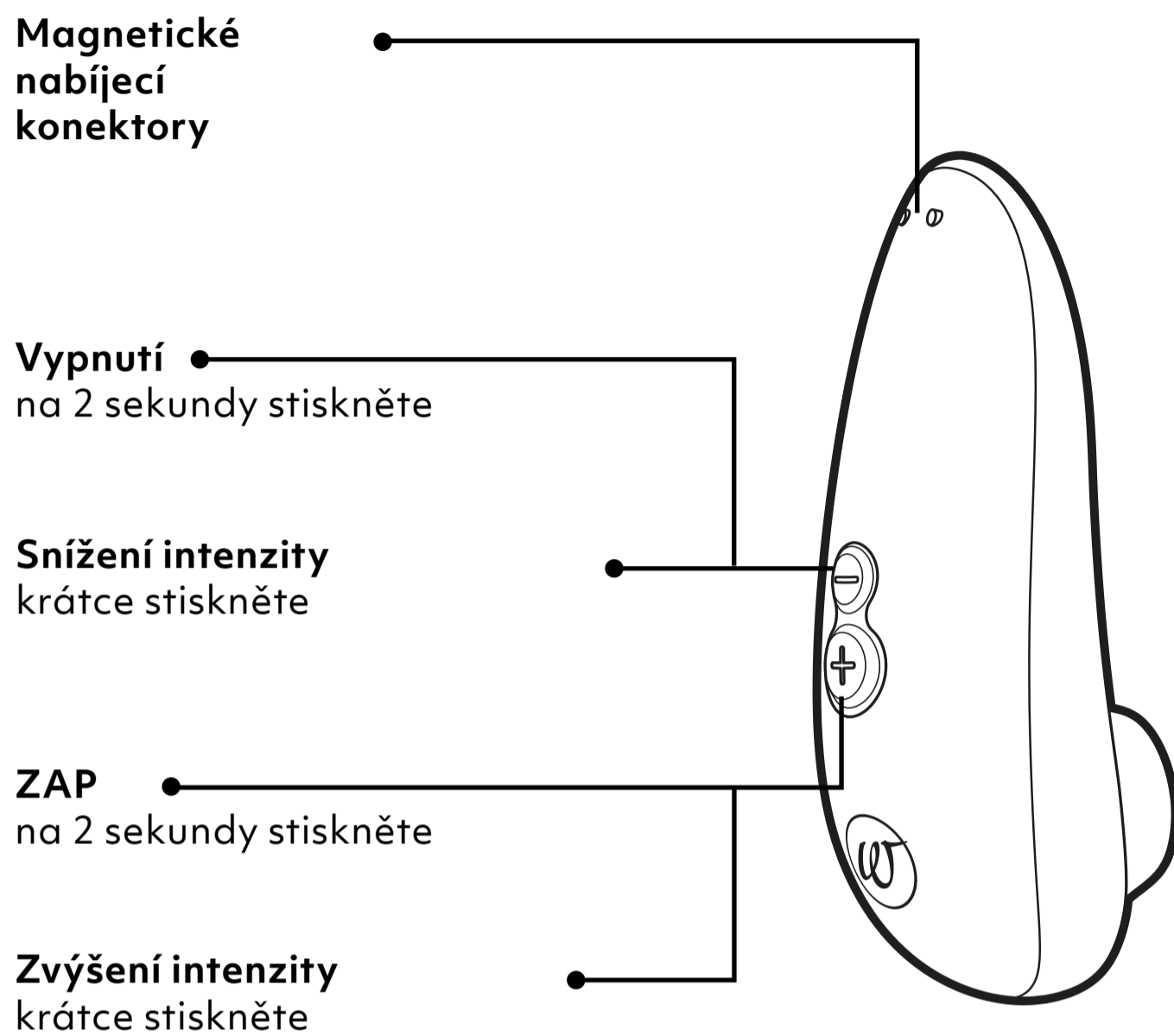

# JAK PRODUKT POUŽÍVAT

## 1. Zapněte

Stiskněte  
a podržte  
stisknuté  
**2 sekundy**

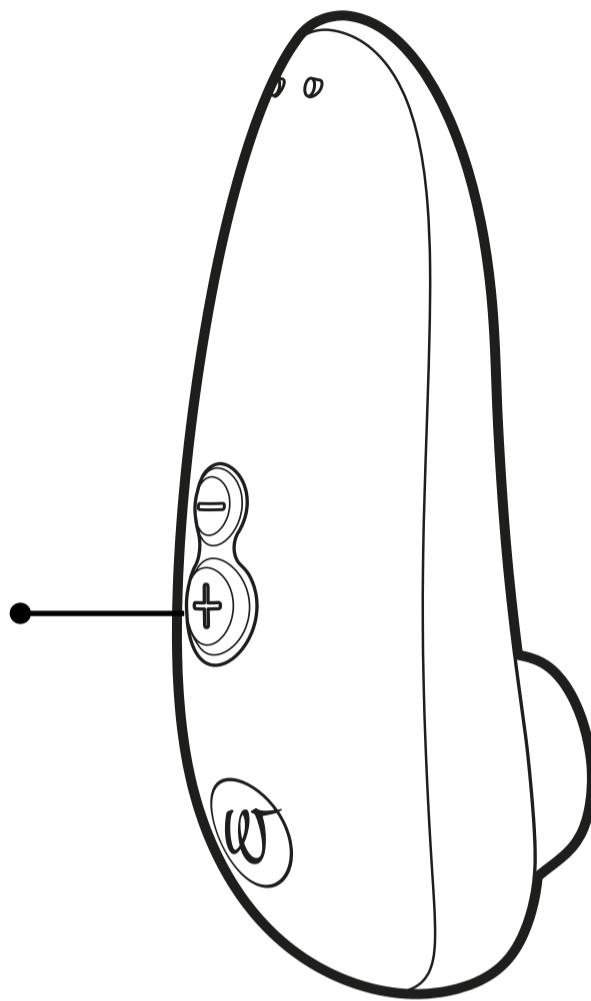

## 2. Použití

Obklopte klitoris stimulačnou hlavicou a vaša cesta sa začína.

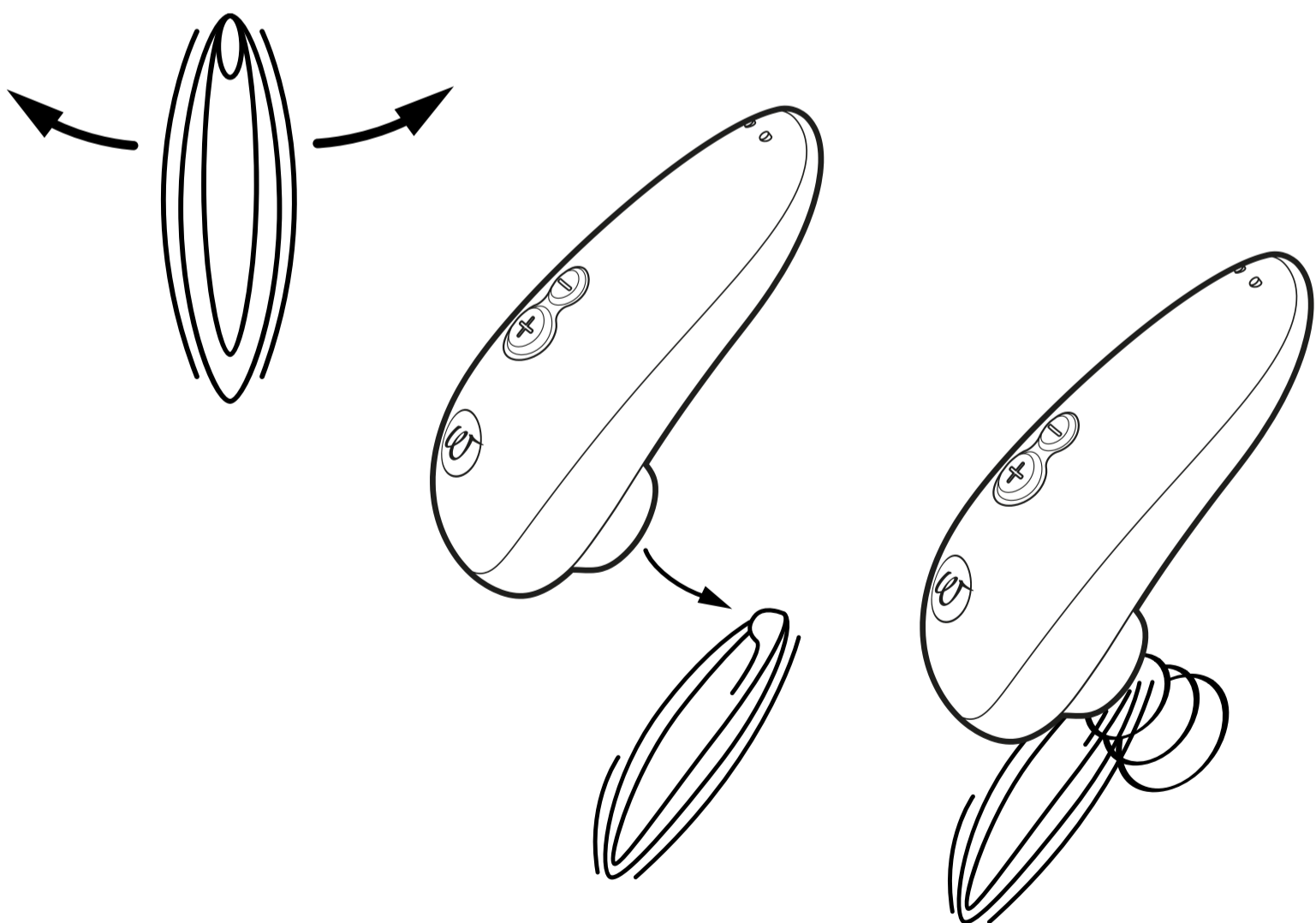

### 3. Změna intenzity

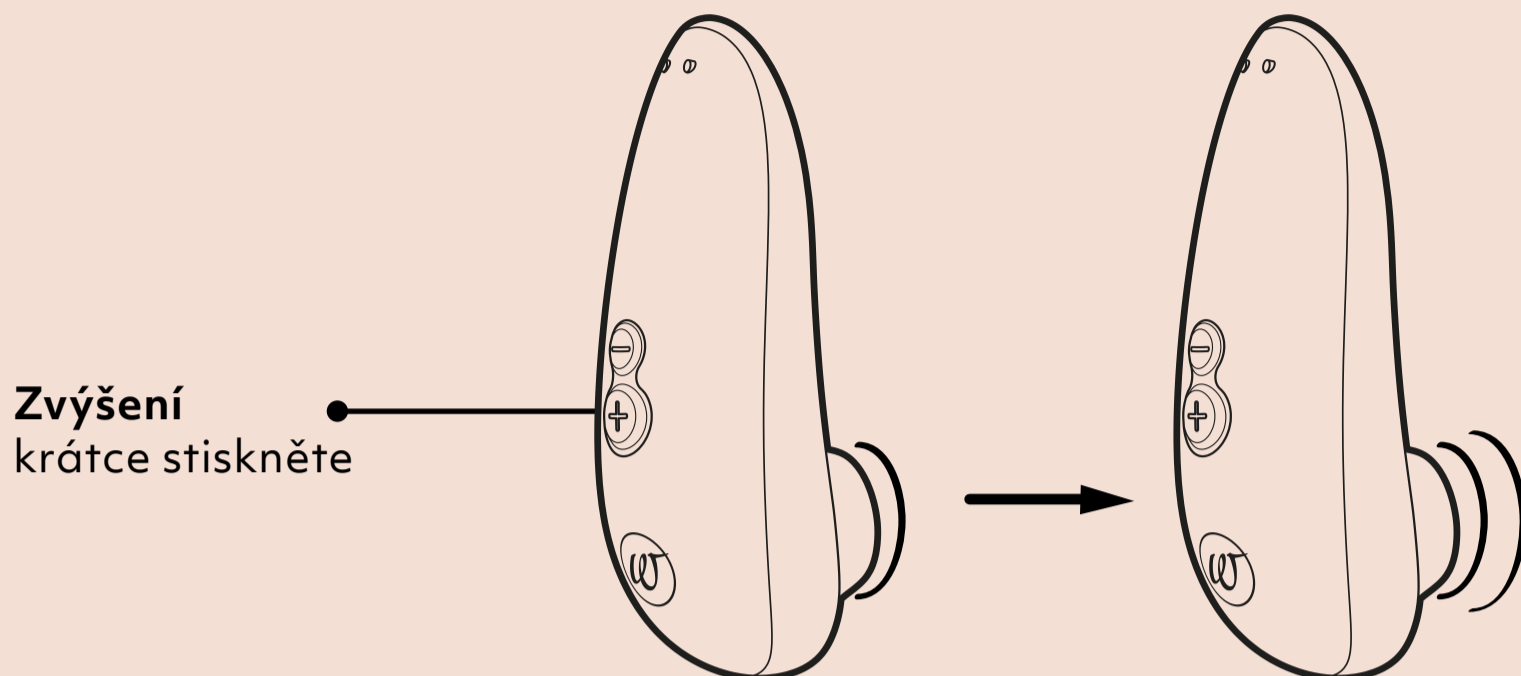

### 6 Úrovně intenzity

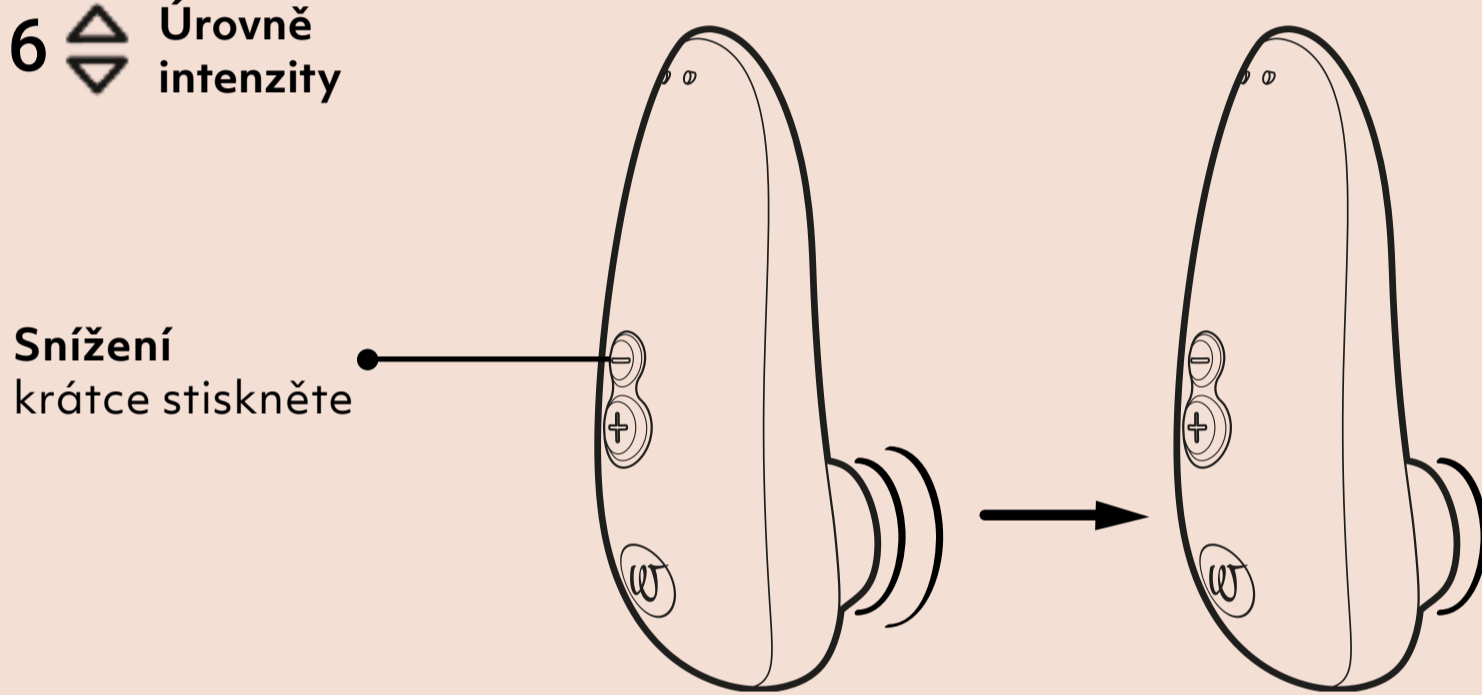

### 4. Vypnutí

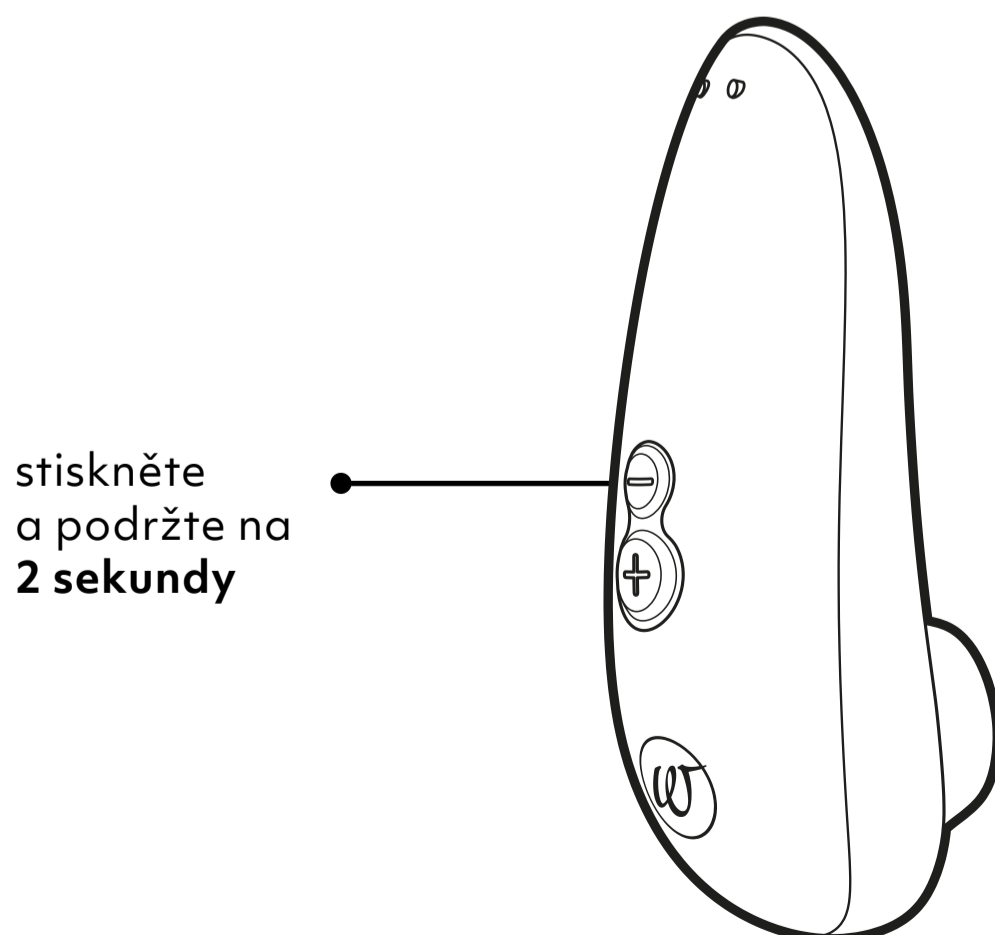

# NABÍJENÍ

Před prvním použitím produkt Womanizer nabijte. Také nezapomeňte nabíjet produkt Womanizer pravidelně, abyste zajistili dlouhou životnost baterie.

**Nabíjení**  
přes USB port

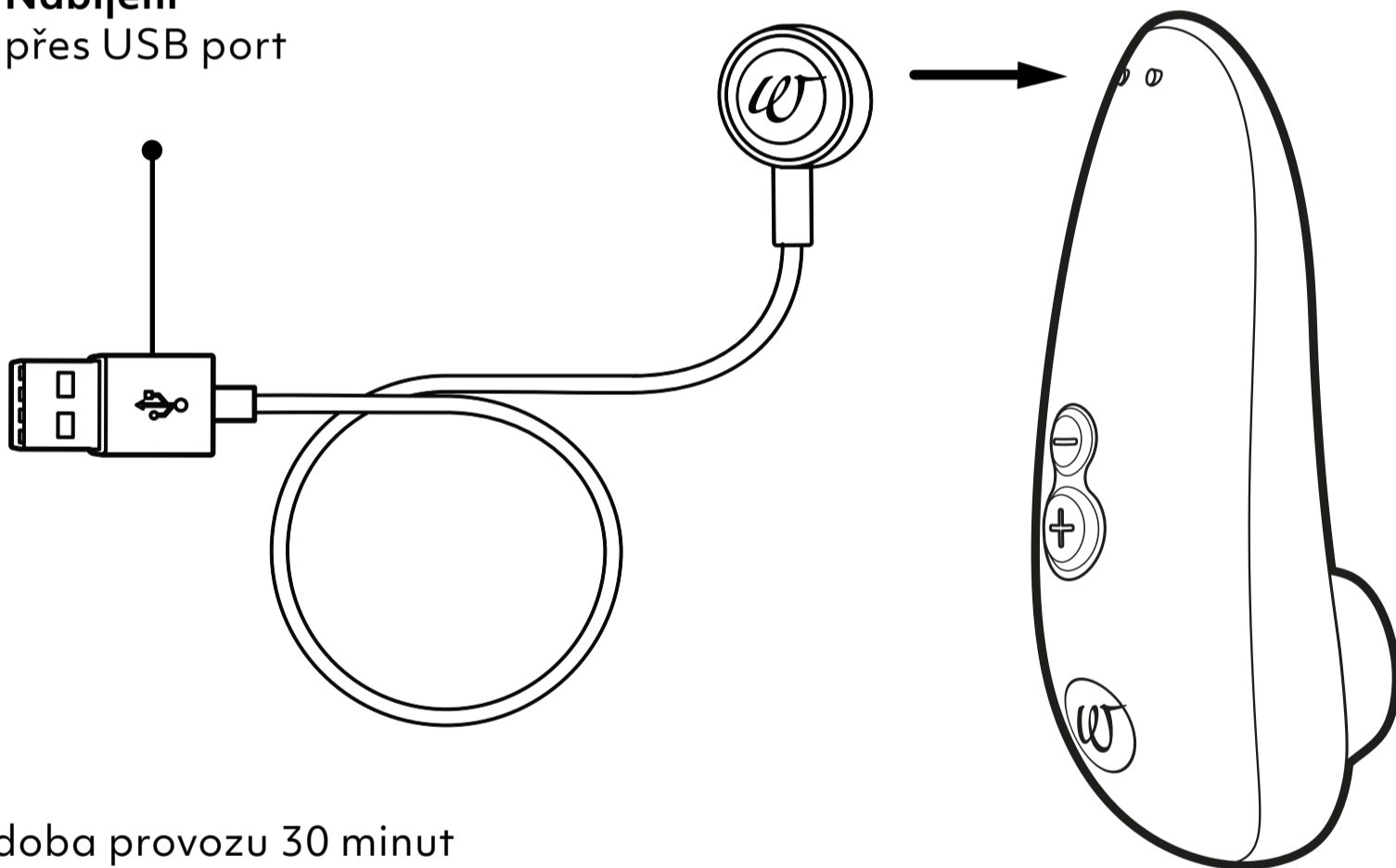

doba provozu 30 minut  
30 minut pro úplné nabití



# ČIŠTĚNÍ

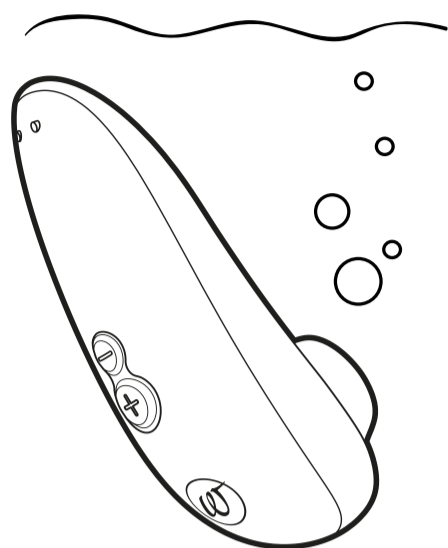

opláchněte pod  
tekoucí vodou

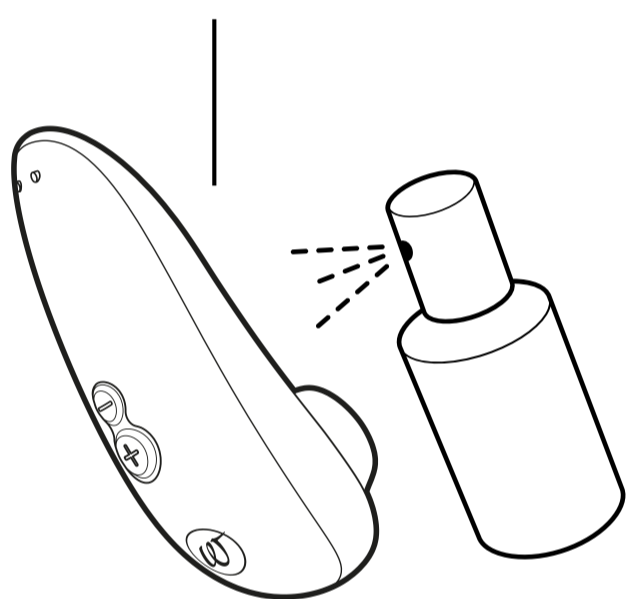

Použijte čistič  
hraček

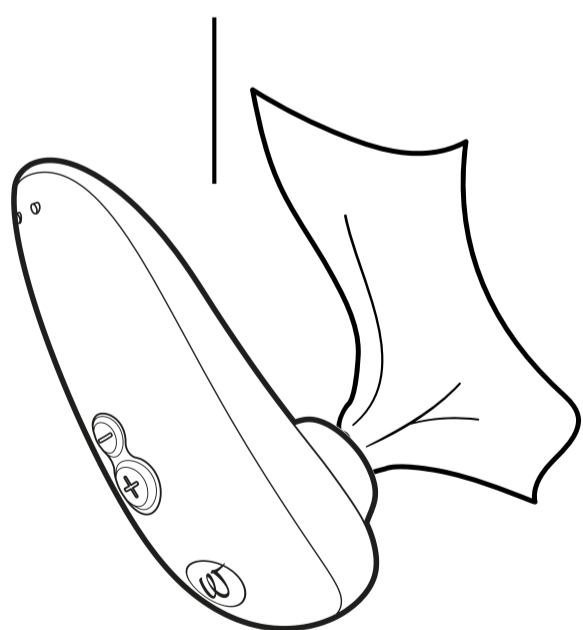

Usušte

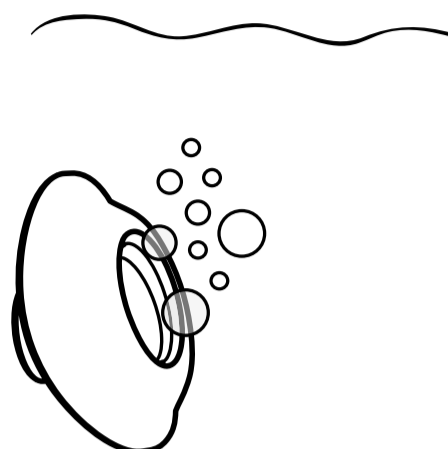

opláchněte pod  
tekoucí vodou

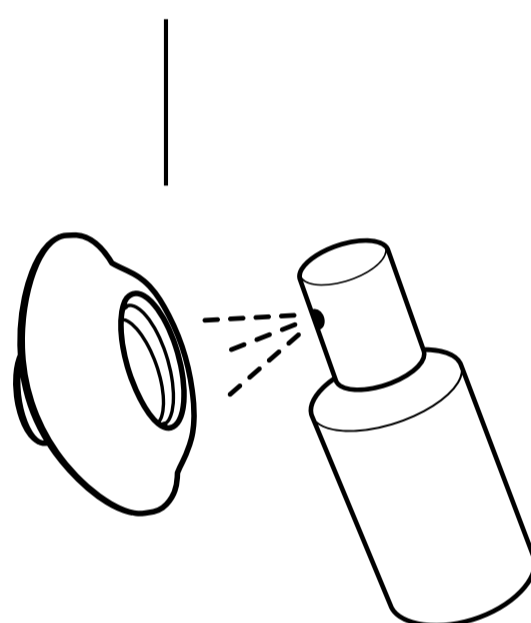

Použijte čistič  
hraček

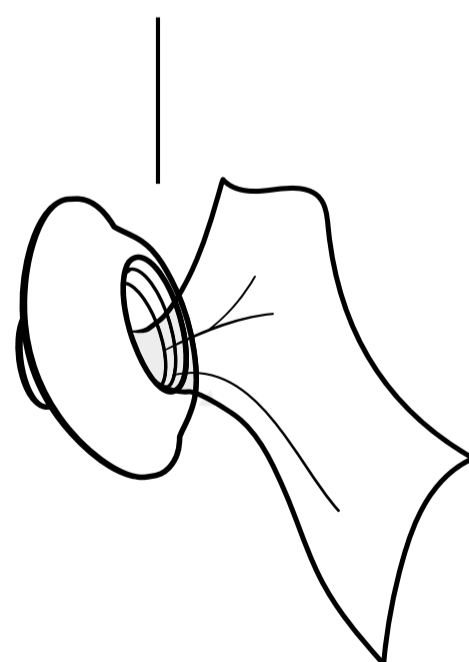

Usušte

+



Waterproof  
IPX7

# OBEČNÉ INFORMACE

## VAROVÁNÍ

Chcete-li předejít poškození, nepoužívejte spolu s produktem Womanizer parfémované lubrikační gely na bázi alkoholu nebo silikonu ani masážní oleje.

Před prvním použitím a po každém dalším použití Womanizer důkladně vyčistěte, abyste snížili riziko infekce.

## PÉČE O ZÁKAZNÍKY

Pro další informace navštivte, prosím, naši webovou stránku [www.womanizer.com](http://www.womanizer.com) nebo nás kontaktujte na [care@womanizer.com](mailto:care@womanizer.com).

## TECHNICKÉ ÚDAJE

Model: WZ15B

Jmenovitý příkon: 3,7 W = 0,135 A:

Integrovaná lithium-iontová dobíjecí baterie.

5 V = 0,75 A: Při nabíjení přes USB.

Nabíjecí zařízení:

USB AC adaptér (není součástí dodávky) s výkonem odpovídajícím jmenovitému výkonu produktu. Nepoužívejte adaptér pro rychlé nabíjení.

## ROZSAH DODÁVKY

Womanizer Starlet 3, USB nabíjecí kabel, stručný průvodce, bezpečnostní pokyny.

## SKLADOVÁNÍ

Skladujte na bezpečném, suchém místě bez vystavení účinkům přímého slunečního záření.

## ZÁRUKA A DOBROVOLNÁ

### ZÁRUKA VÝROBCE

Společnost WOW TECH EUROPE GMBH nabízí zákazníkům na tento produkt nad rámec zákonné záruky, na kterou mají spotřebitelé nárok, dobrovolnou záruku výrobce.

Podmínky týkající se dobrovolné záruky výrobce jsou uvedeny na naší webové stránce v části „Záruční podmínky“.

## PLNĚNÍ STANDARDŮ

Tento spotřebič splňuje všechny normy týkající se elektromagnetické kompatibility (EMC). Zařízení je bezpečné při použití, pokud je používáno správně

a v souladu s pokyny uvedenými v tomto návodu.

## OCHRANA ŽIVOTNÍHO PROSTŘEDÍ

Jako distributor elektronických zařízení máme zákonem uloženou povinnost bezplatně přijímat vrácená elektrická a elektronická zařízení.

Výslovně uvádíme, že Vy jako uživatel jste povinni vrátit použité baterie.

Elektronická zařízení ani baterie nikdy nevyhazujte do domácího odpadu.

Tuto skutečnost Vám má výslovně připomenout níže uvedený symbol, který je také umístěný na elektronických prvcích.

## DISTRIBUTOR

WOW Tech Europe GmbH,  
Friedenstrasse 91 / 91 a, 10249 Berlin, Německo

Společnost WOW Tech Europe GmbH si vyhrazuje právo provádět technické a konstrukční změny, které slouží ke zlepšení zařízení.

Distribučováno v Severní Americe společností WOW TECH Canada Ltd.  
1545 Carling Avenue, Suite 401, Ottawa ON, Canada K1Z 8P9

[www.wowtech.com](http://www.wowtech.com) Navrženo v Německu. Vyrobeno v Číně v roce 2021. Příručka vydána v 02/2021. Verze 1.



# STÁLE NEJSTE SPOKOJENI?

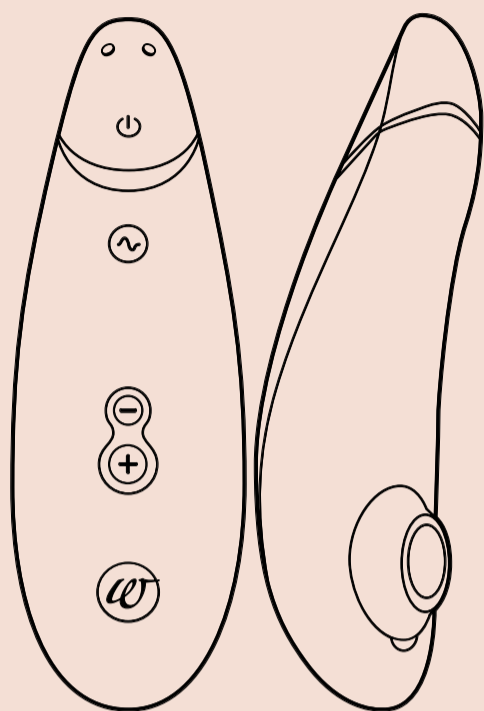

**Pleasure Air  
Technology**



**Smart Silence**

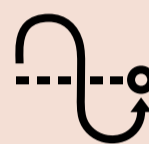

**Autopilot**

**Premium 2**  
Define your luxury

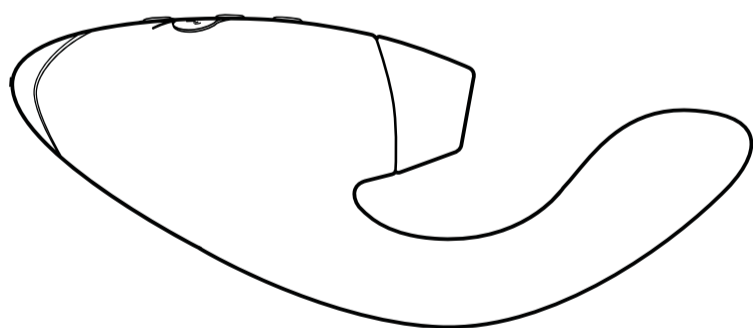

**Pleasure Air  
Technology**



**Vibrator**



**Smart Silence**

**DUO**  
Double your Pleasure



**#IMASTURBATE**

# Привет!

**Womanizer - правильный выбор!**

Добро пожаловать в мир, полный чувственных удовольствий, способных обогатить твою жизнь. WOMANIZER гарантирует тебе не только несравнимые оргазмы, но и совершенно новое качество удовольствия.

**Позволь WOMANIZER подарить тебе один оргазм за другим.**

Займись с собой любовью!



ОПИСАНИЕ ИЗДЕЛИЯ

ИНСТРУКЦИЯ ПО ИСПОЛЬЗОВАНИЮ

ЗАРЯДКА

ОЧИСТКА

ОБЩАЯ ИНФОРМАЦИЯ

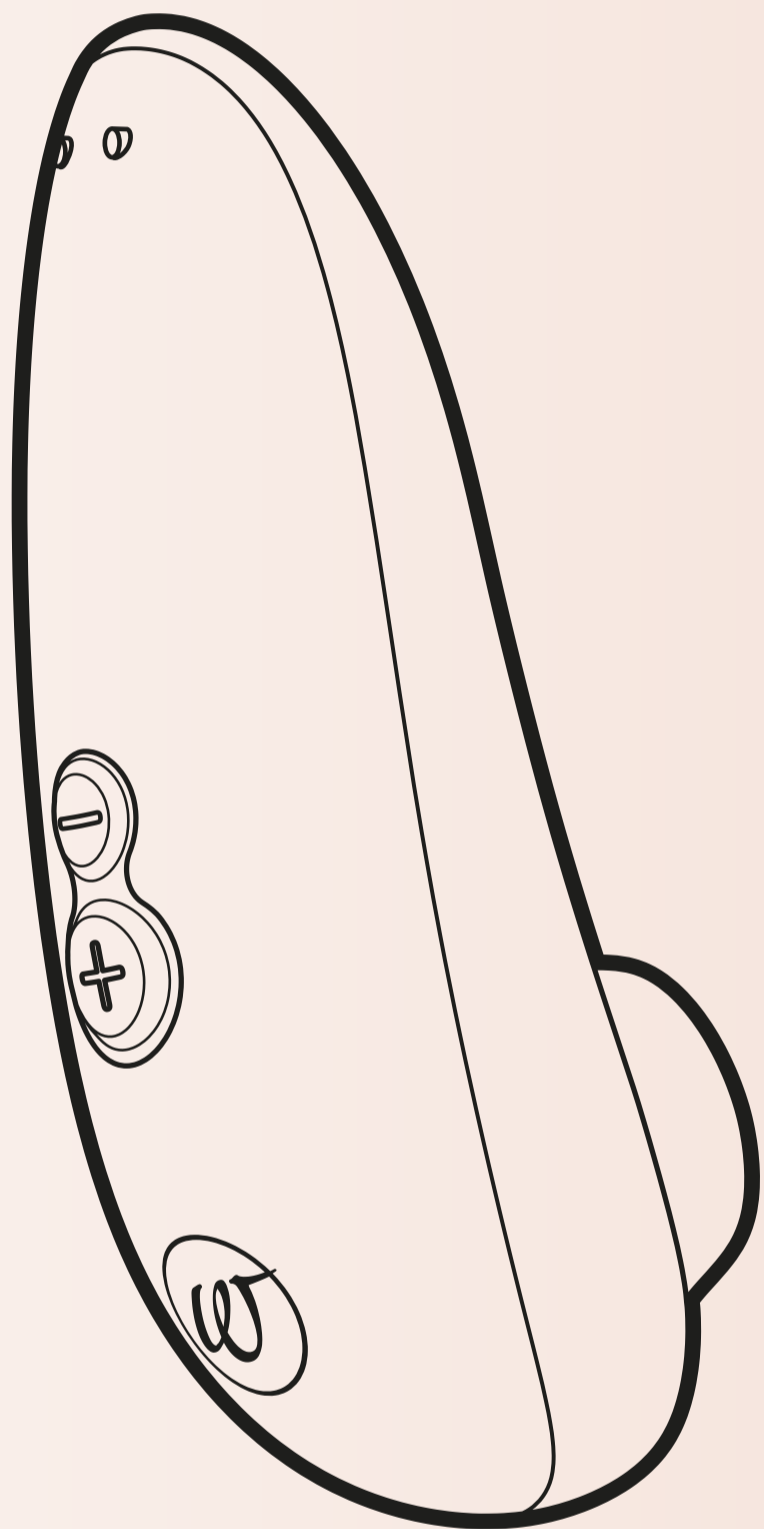

# ОПИСАНИЕ ИЗДЕЛИЯ

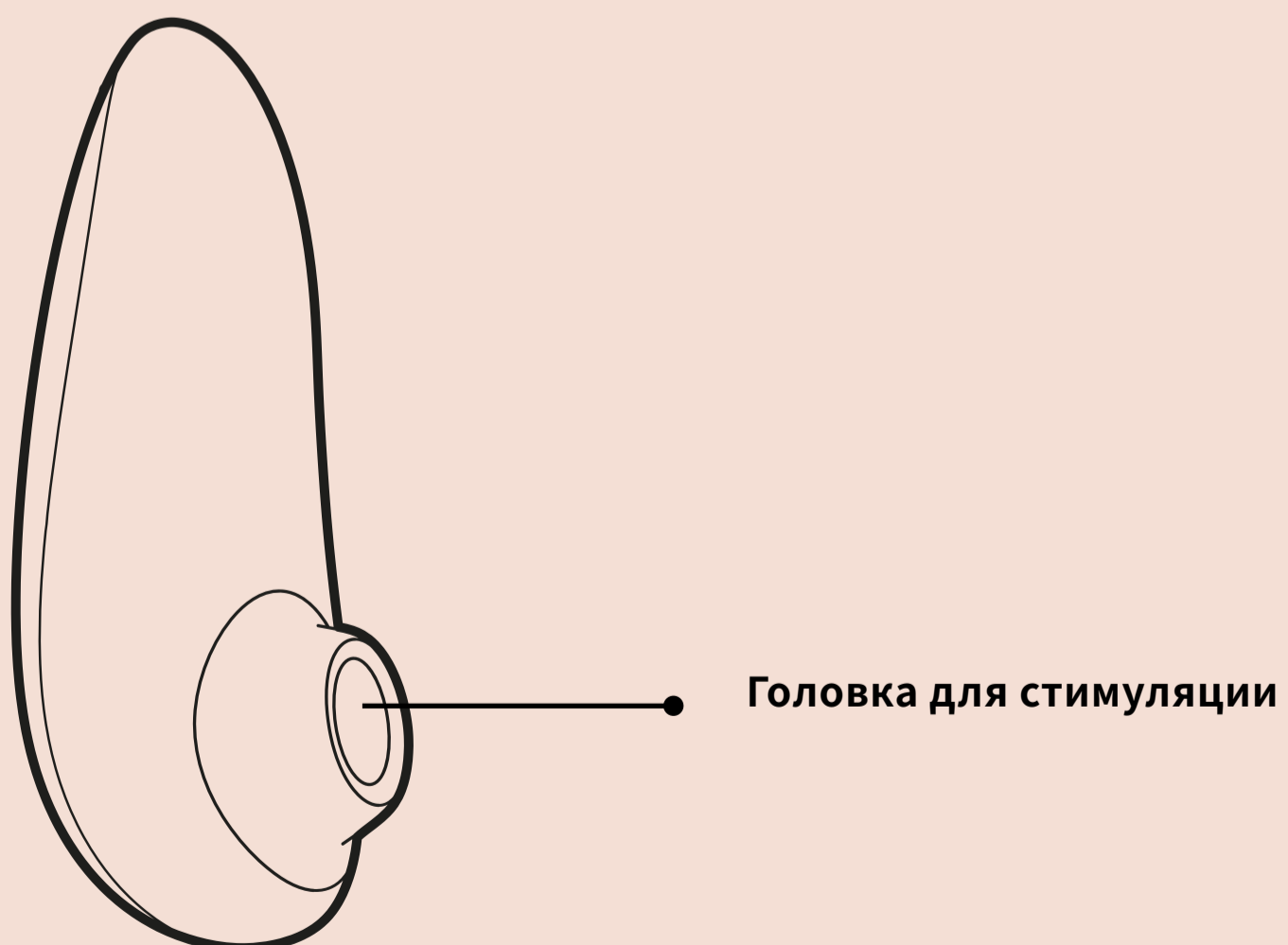
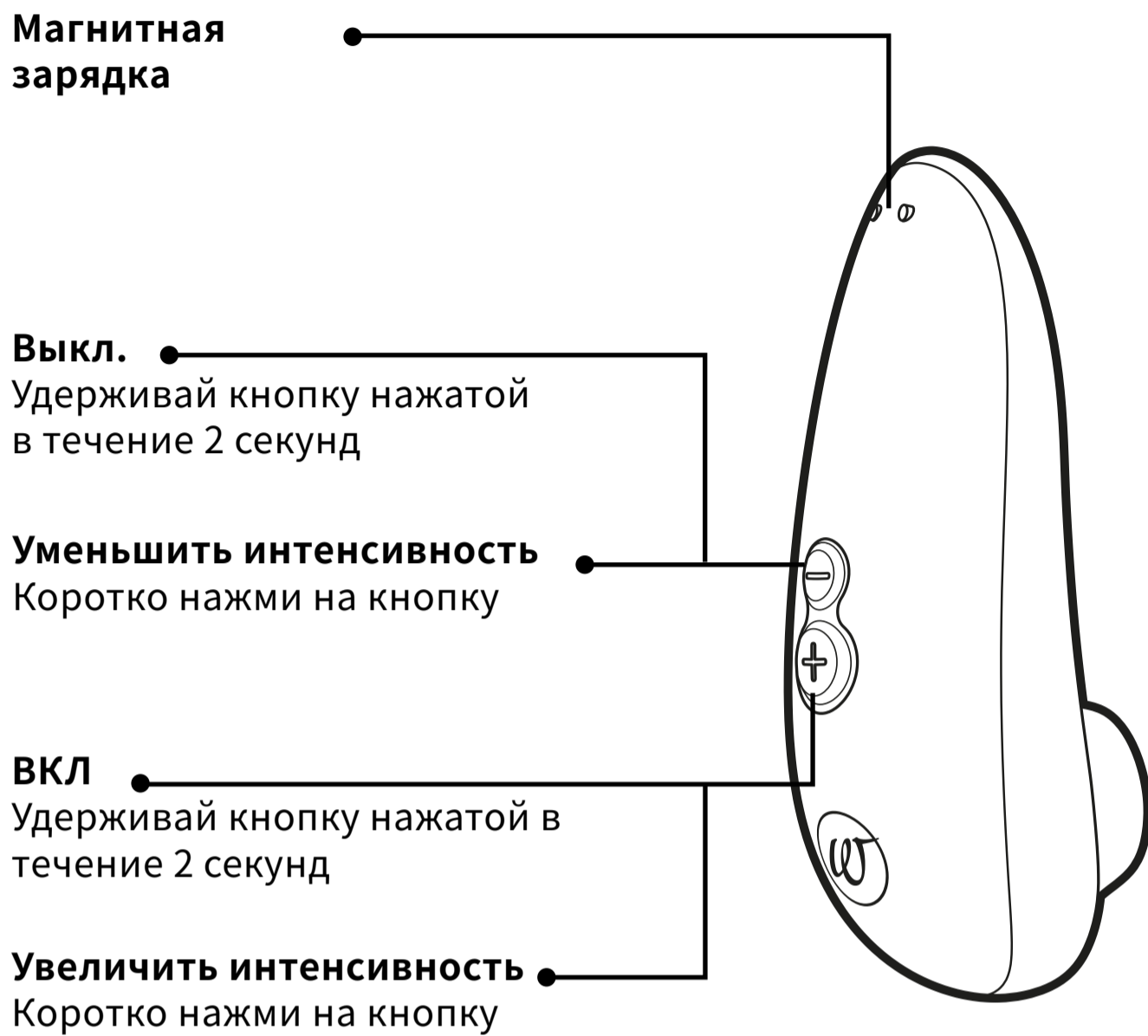



# ИНСТРУКЦИЯ ПО ИСПОЛЬЗОВАНИЮ

## 1. Включение

Удерживай  
кнопку нажатой  
в течение 2  
секунд

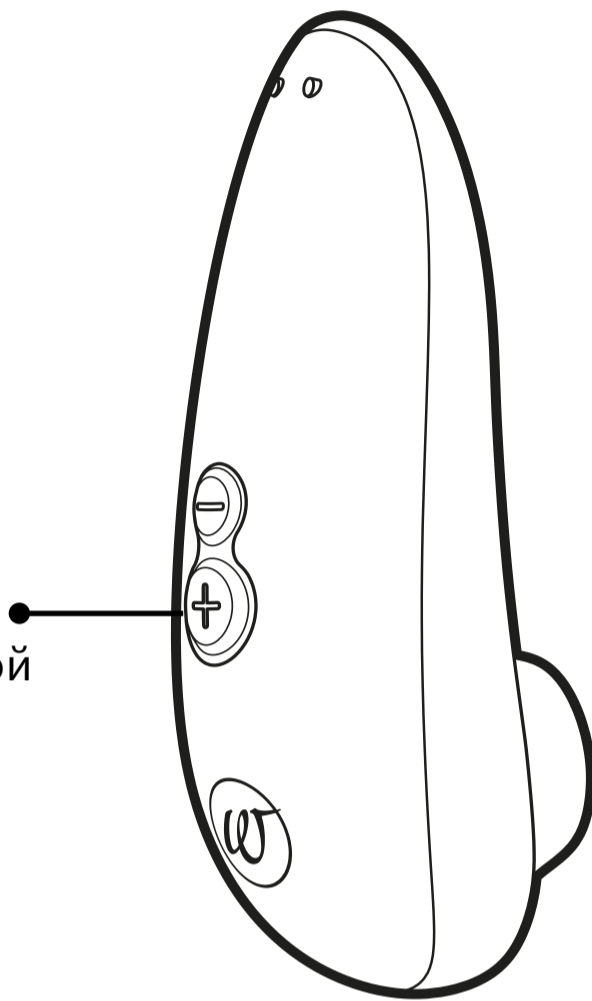

## 2. Способ использования

Направьте стимулирующую головку  
на клитор и начинайте чувственное путешествие.

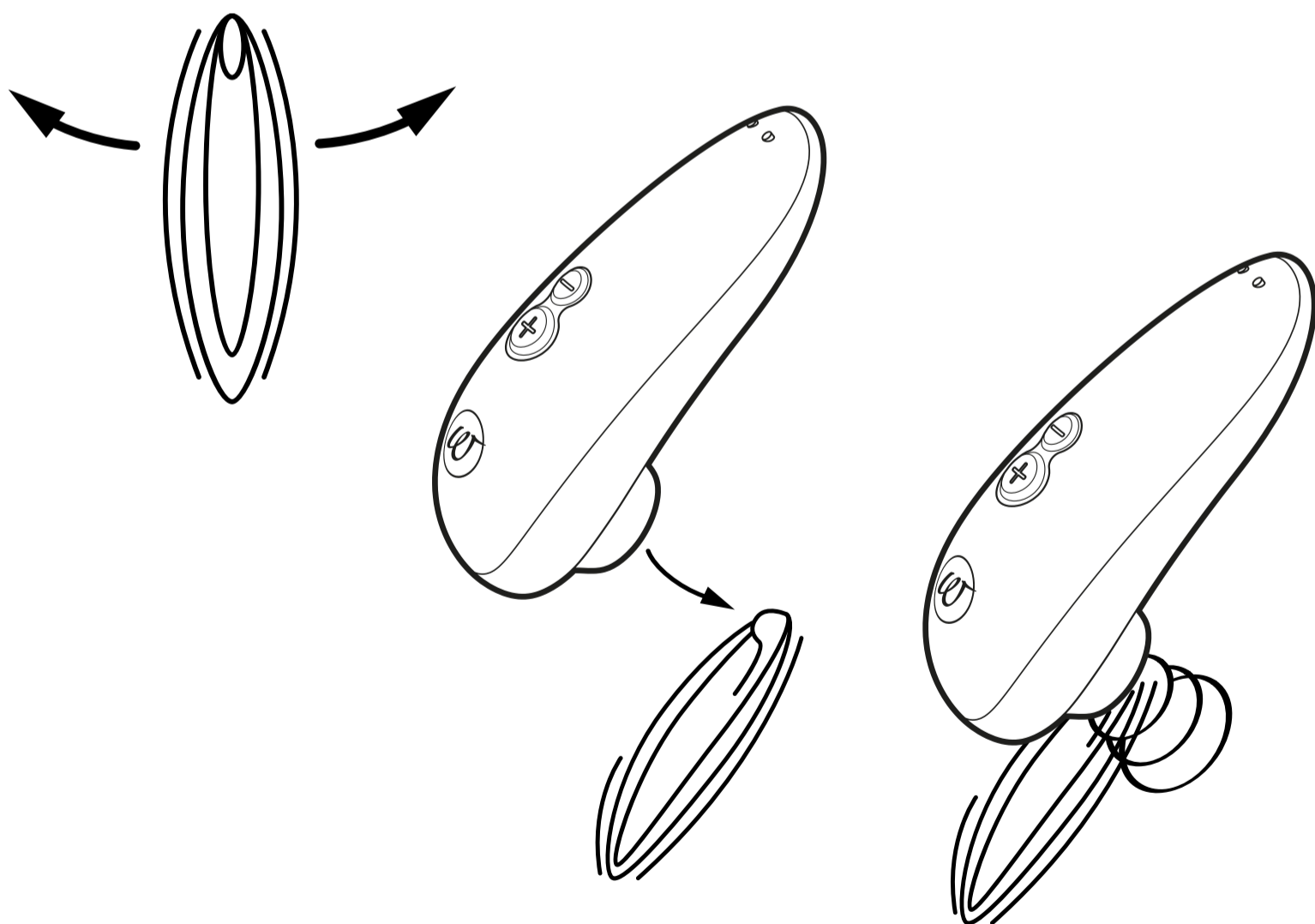

### 3. Регулировка интенсивности

**Уменьшение  
интенсивности**  
Коротко нажми на  
кнопку

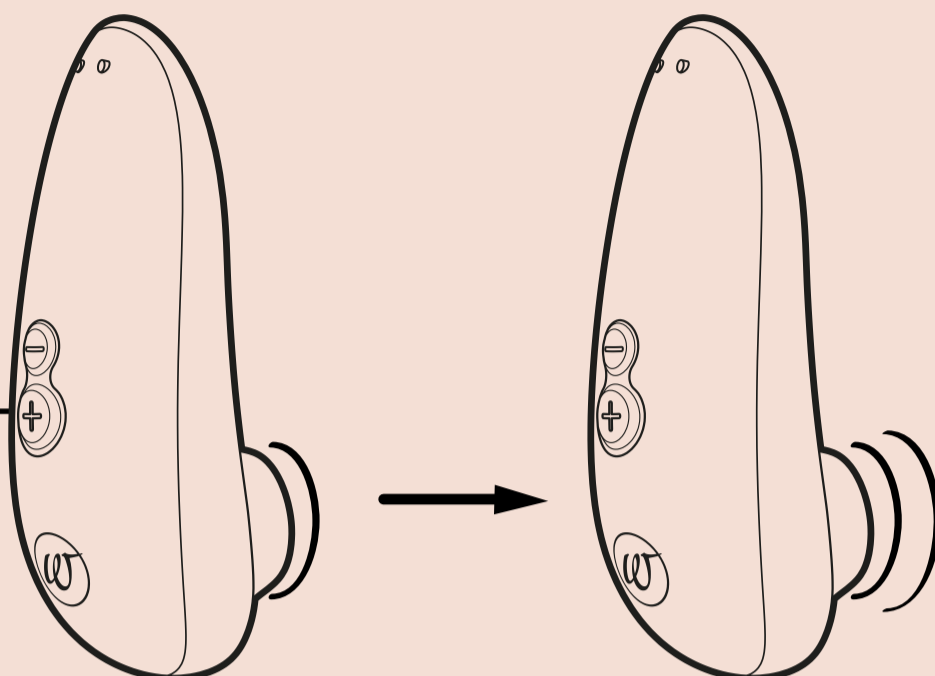

**6**  **Уровни  
интенсивности**

**Увеличение  
интенсивности**  
Коротко нажми на  
кнопку

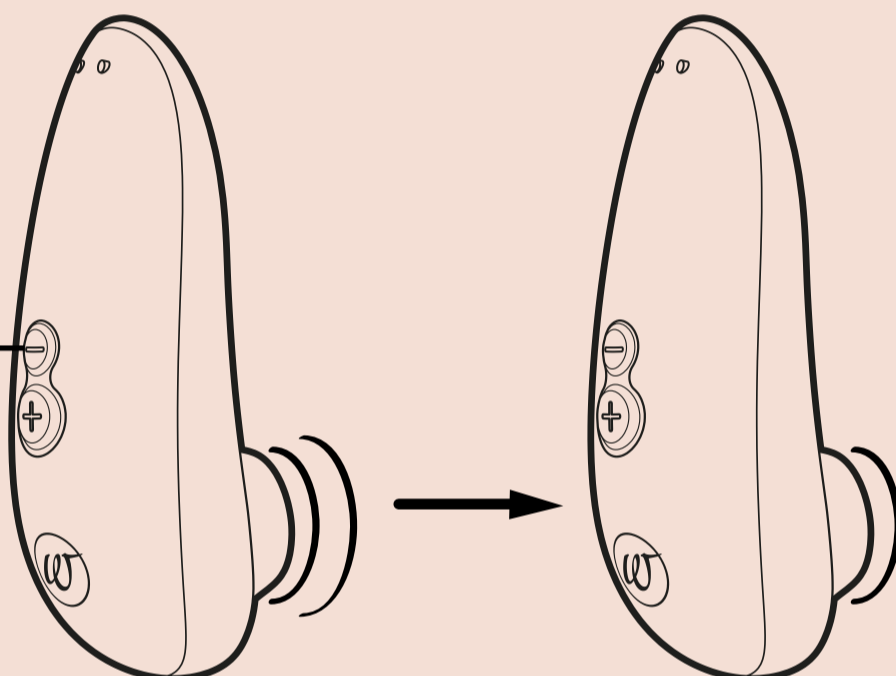

### 4. Вкл./выкл.

Удерживай  
кнопку нажатой  
**в течение  
2 секунд**

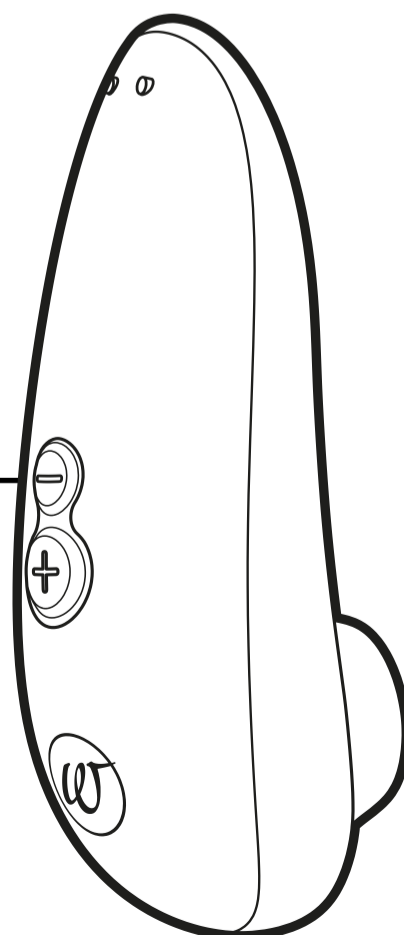

# ЗАРЯДКА

Полностью заряди устройство перед первым использованием. Чтобы гарантировать длительное время работы, необходимо регулярно заряжать Womanizer.

**Зарядка**  
с помощью USB

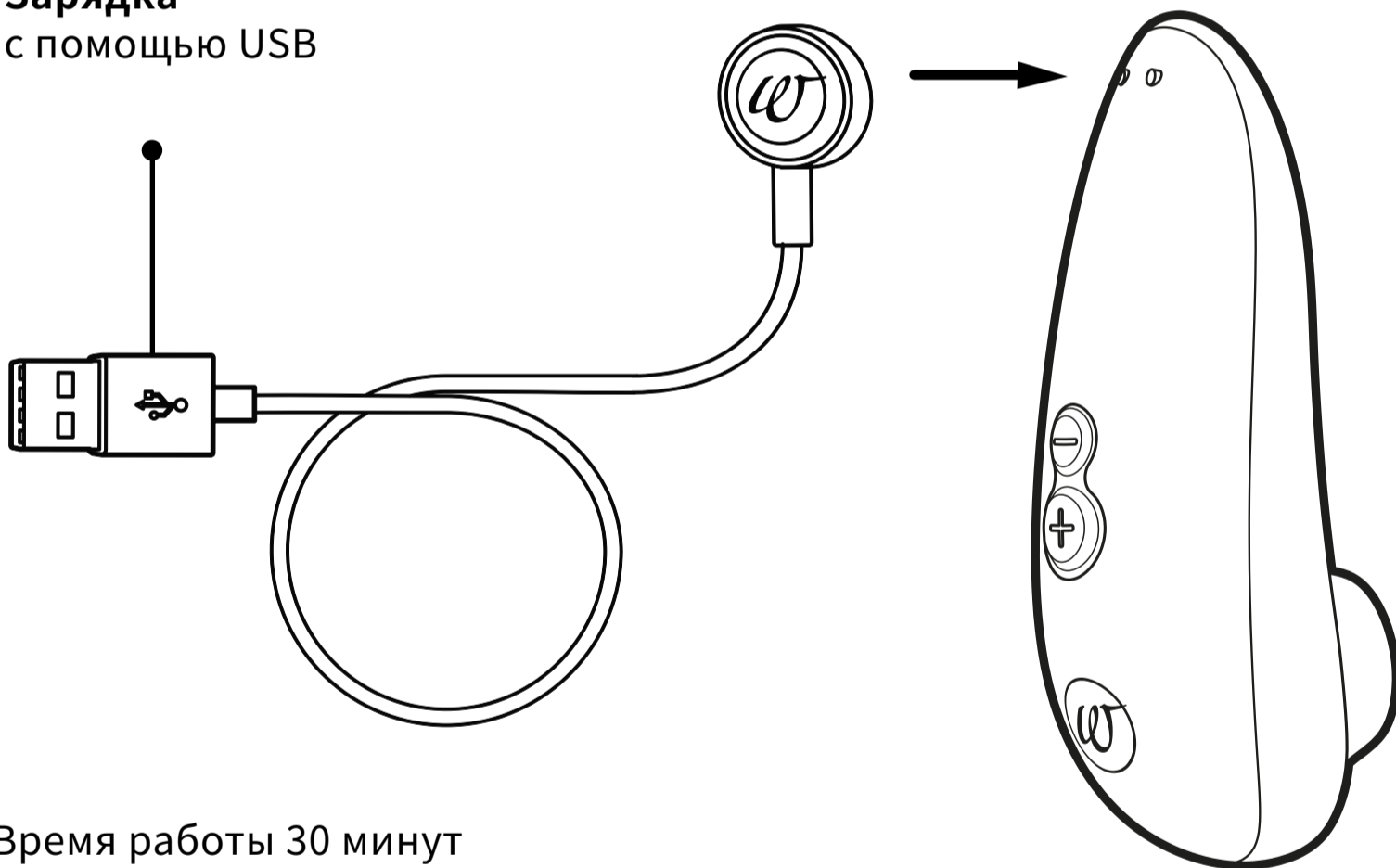

Время работы 30 минут  
Время полной зарядки 30 минут

# ОЧИСТКА

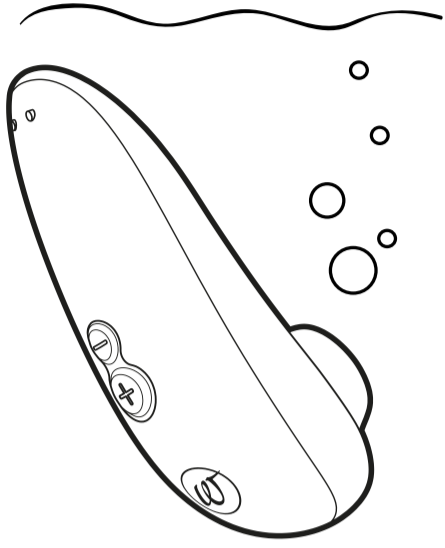

Помой изделие  
водой

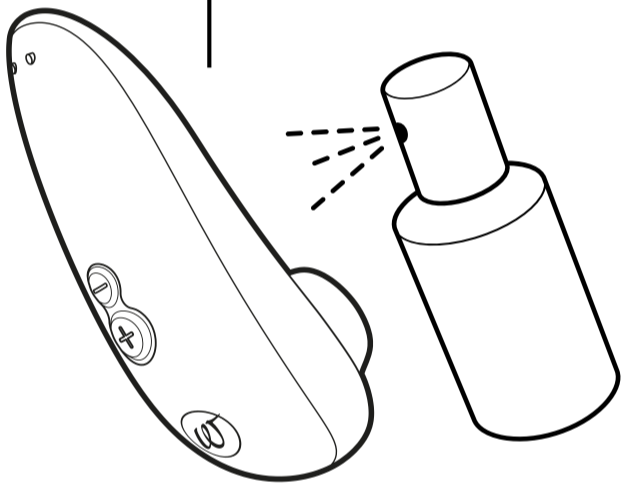

Нанеси средство для  
очистки секс-игрушек

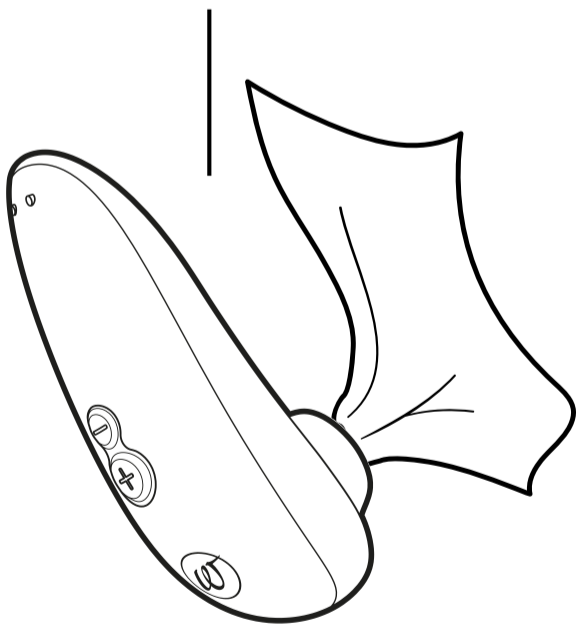

Вытри насухо

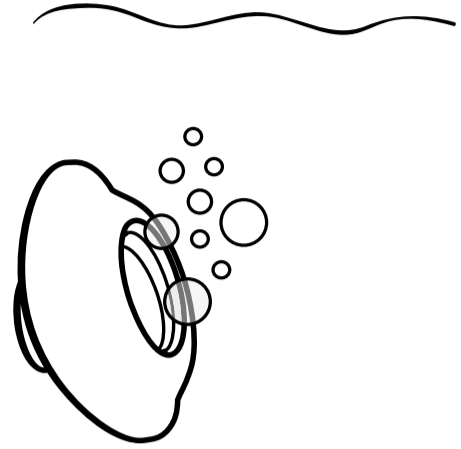

Помой изделие  
водой

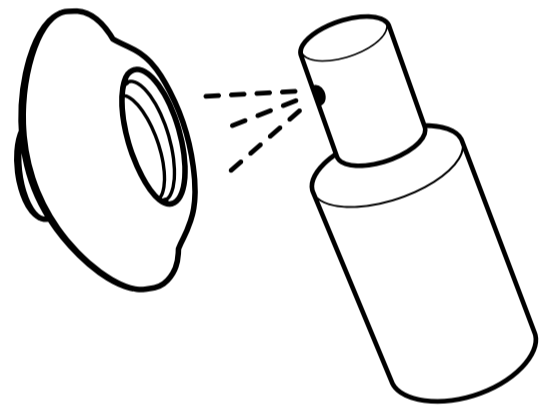

Нанеси средство для  
очистки секс-игрушек

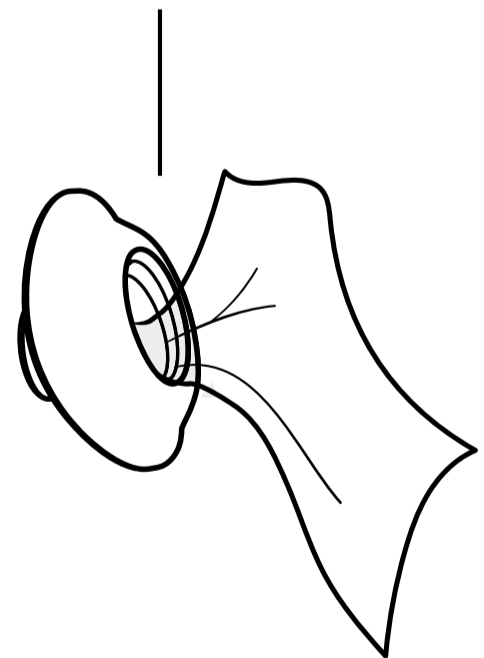

Вытри насухо



Waterproof  
IPX7

# ОБЩАЯ ИНФОРМАЦИЯ

## ПРЕДУПРЕЖДЕНИЕ

Во избежание повреждений устройства не следует использовать ароматизированные или силиконовые смазки, смазки на спиртовой основе, а также гели или массажные масла. Тщательно очисти Womanizer перед первым использованием, а также очищай его после каждого использования, чтобы снизить риск заражения.

## СЕРВИСНАЯ СЛУЖБА

Подробная информация представлена на сайте [www.womanizer.com](http://www.womanizer.com) или по запросу на адрес электронной почты [care@womanizer.com](mailto:care@womanizer.com).

## ТЕХНИЧЕСКИЕ ХАРАКТЕРИСТИКИ

Модель: WZ15B

Электрические характеристики: 3,7 V --- 0,135 A:

Встроенная литий-ионная аккумуляторная батарея.

5 V --- 0,75 A: Зарядка с помощью USB.

Устройство зарядки:

адаптер переменного тока USB

(не входит в комплект) с выходной мощностью, соответствующей изделию

Не рекомендуется использовать адаптер для быстрой зарядки.

## В КОМПЛЕКТ ВХОДИТ

Womanizer Starlet 3, USB-кабель для зарядки, краткое руководство пользователя, инструкция по технике безопасности.

## ХРАНЕНИЕ

Храни изделие в надежном, сухом месте, избегая воздействия прямых солнечных лучей.

## ГАРАНТИЙНЫЕ ОБЯЗАТЕЛЬСТВА И ДОБРОВОЛЬНАЯ

### ГАРАНТИЯ ПРОИЗВОДИТЕЛЯ

В дополнение к законодательно предусмотренной гарантии компания WOW TECH EUROPE GMBH предлагает клиентам добровольную гарантию производителя на данное изделие. Условия добровольной гарантии производителя приведены на нашем сайте в разделе «Гарантийные условия».

## СООТВЕТСТВИЕ СТАНДАРТАМ

Данное изделие соответствует всем стандартам электромагнитной совместимости (ЭМС). Изделие безопасно для использования до тех пор, пока оно используется по назначению и в соответствии с инструкциями, приведенными в данном руководстве пользователя.

## ЗАЩИТА ОКРУЖАЮЩЕЙ СРЕДЫ

Как дистрибьютор электронных устройств, мы по закону обязаны принимать отработавшие электрические и электронные устройства бесплатно. По закону пользователи обязаны вернуть отработавшие аккумуляторные батареи. Никогда не выбрасывай электронные устройства или батарейки в бытовые отходы.

Символ, изображенный ниже, нанесен на наши электронные изделия с целью напомнить об этом.

## ДИСТРИБЬЮТОР

WOW Tech Europe GmbH,  
Friedenstrasse 91 / 91 a, 10249 Berlin,  
Германия

WOW Tech Europe GmbH оставляет за собой право вносить технические изменения, а также изменения в конструкцию с целью совершенствования изделия.

В Северной Америке продукция распространяется компанией WOW TECH Canada Ltd. 1545 Carling Avenue, Suite 401, Ottawa, Онтарио, Канада K1Z 8P9

[www.wowtech.com](http://www.wowtech.com) Разработано в Германии. Произведено в Китае в 2021. Руководство пользователя вышло 02/2021. Версия 1.

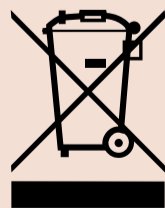

# ВСЁ ЕЩЕ ХОЧЕШЬ БОЛЬШЕГО?

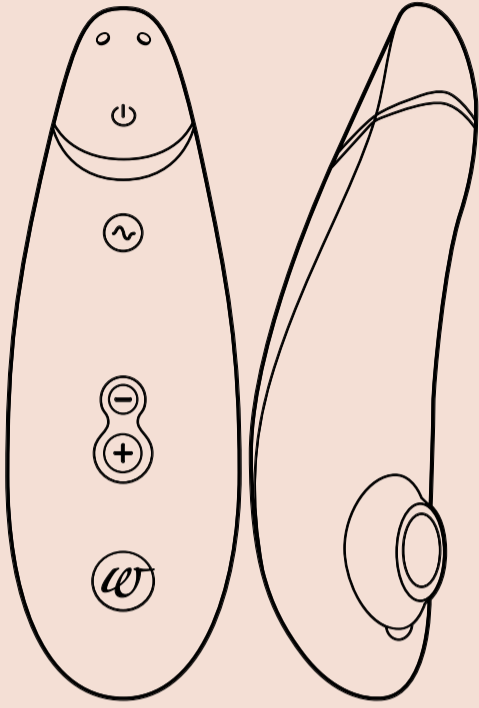

**Pleasure Air  
Technology**



**Smart Silence**

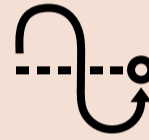

**Autopilot**

**Premium 2**  
Define your luxury

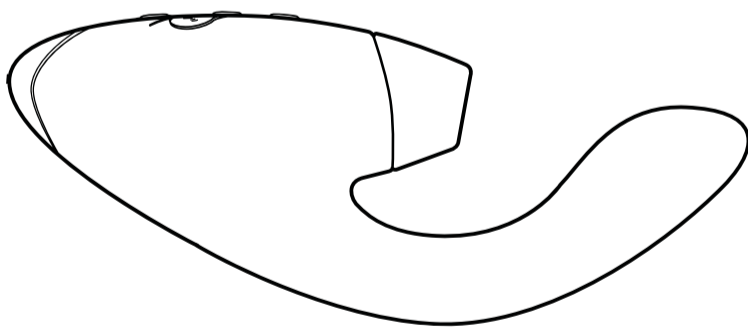

**Pleasure Air  
Technology**



**Vibrator**



**Smart Silence**

**DUO**  
Double your Pleasure



**#IMASTURBATE**

# Dzień dobry!

**Dziękujemy, że wybrałaś Womanizer!**

Witaj w świecie pełnym zmysłowych doznań, które wzbogacą Twoje życie. Wybierając WOMANIZER, odkryjesz nie tylko niezrównane orgazmy - lecz także zupełnie nowe pragnienie przyjemności.

**Poznaj WOMANIZER - jeden orgazm za drugim.**

Pokochaj się!





**OPIS PRODUKTU**

**SPOSÓB UŻYCIA**

**ŁADOWANIE**

**CZYSZCZENIE**

**INFORMACJE OGÓLNE**

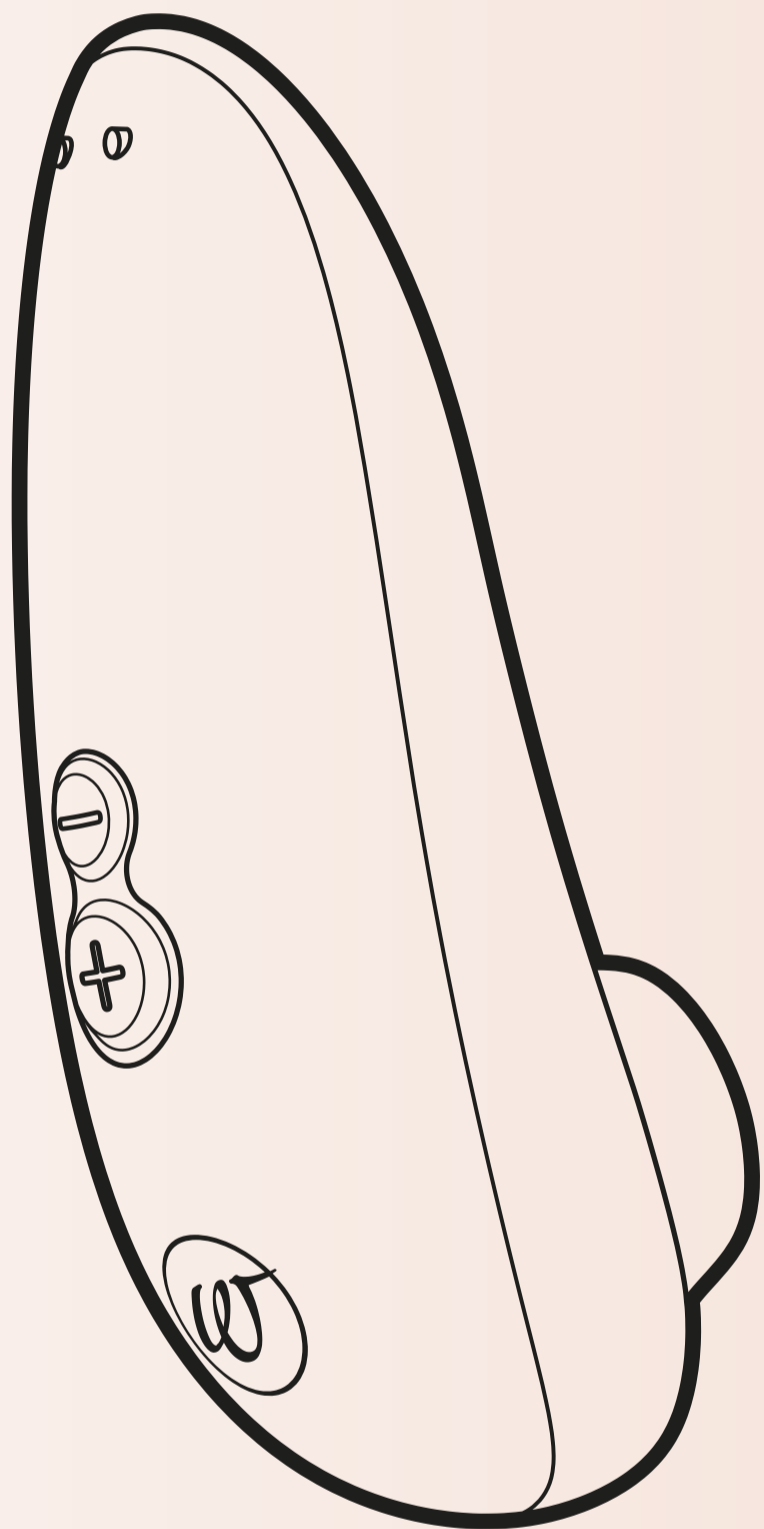

# OPIS PRODUKTU

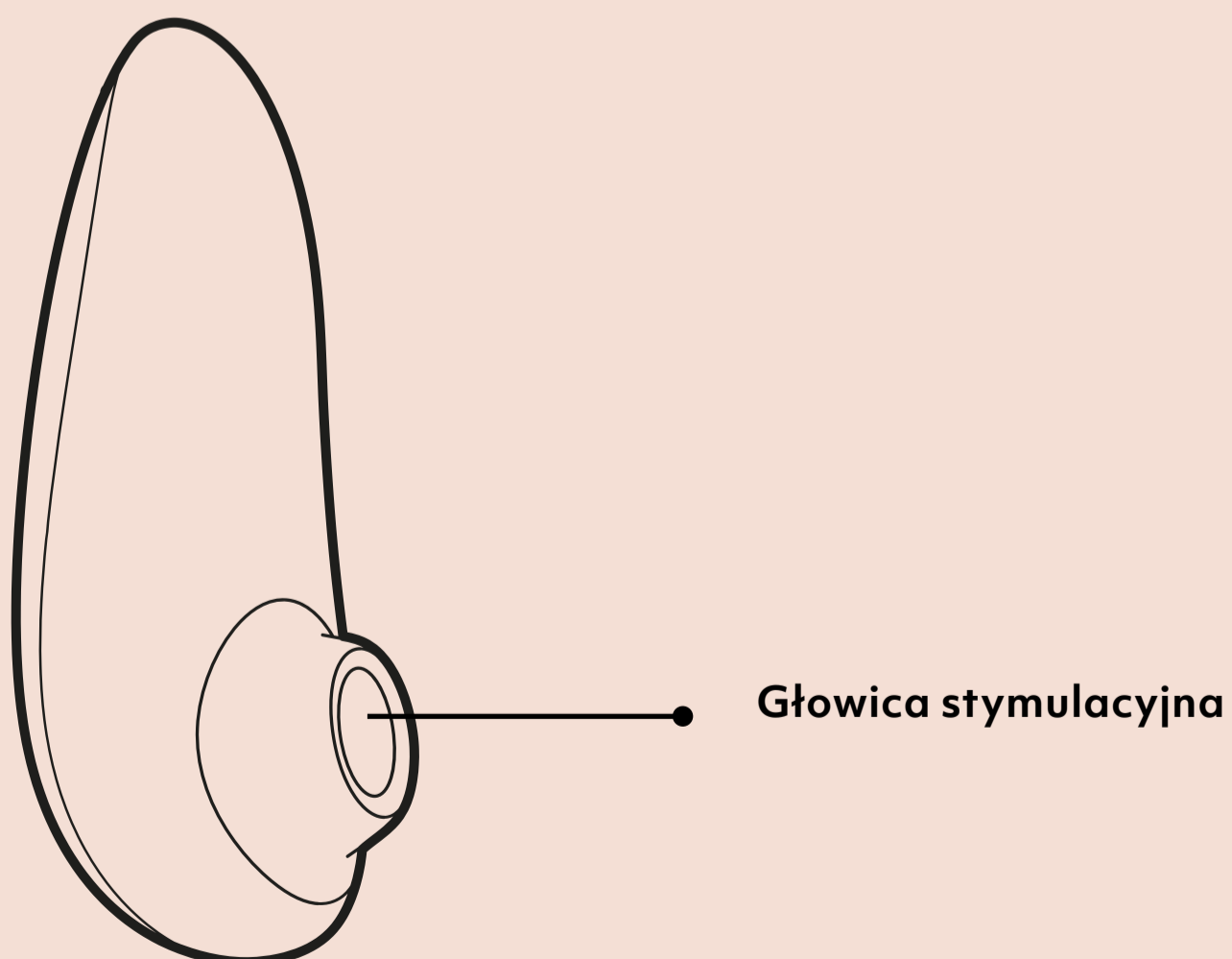
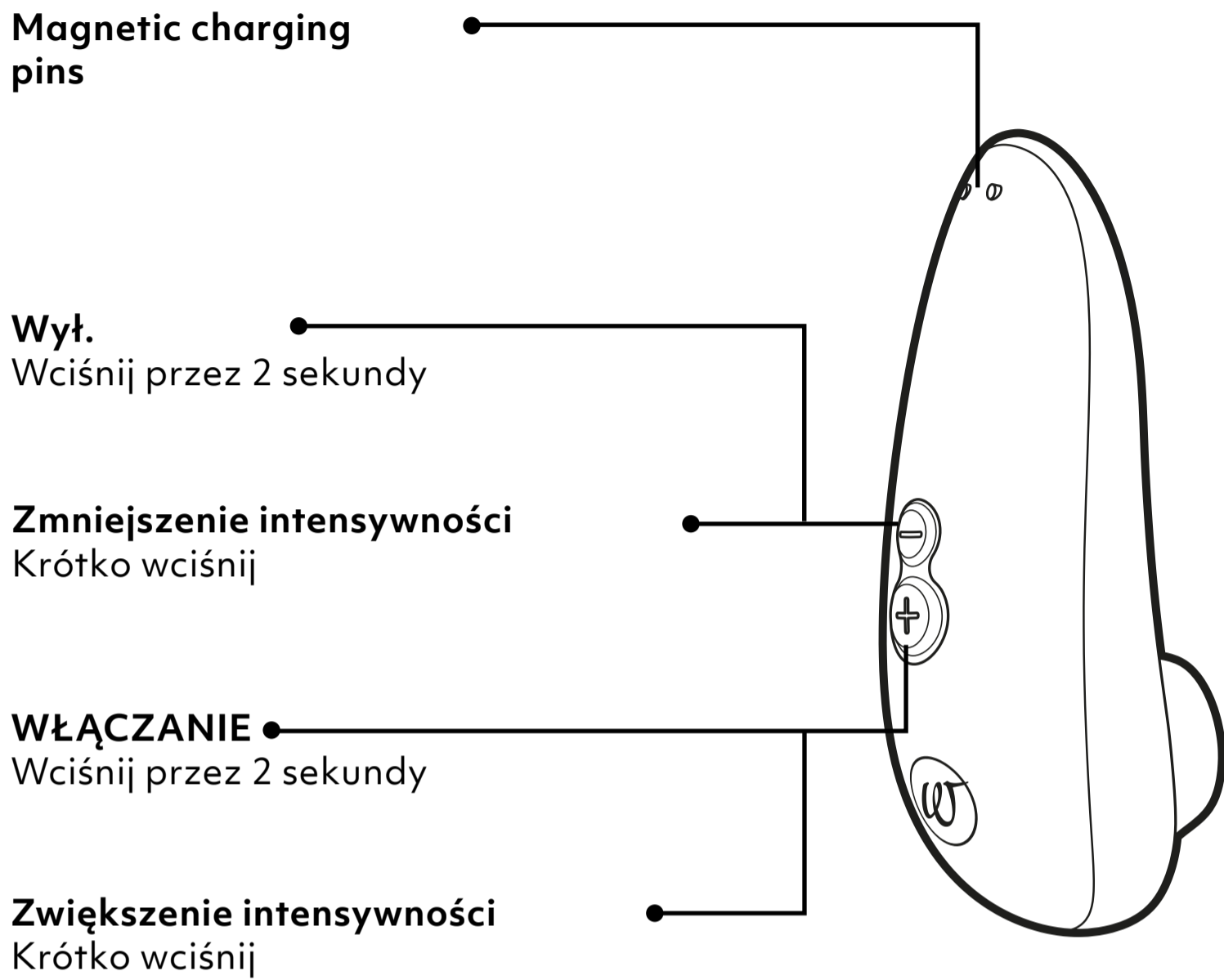

# SPOSÓB UŻYCIA

## 1. Włącz

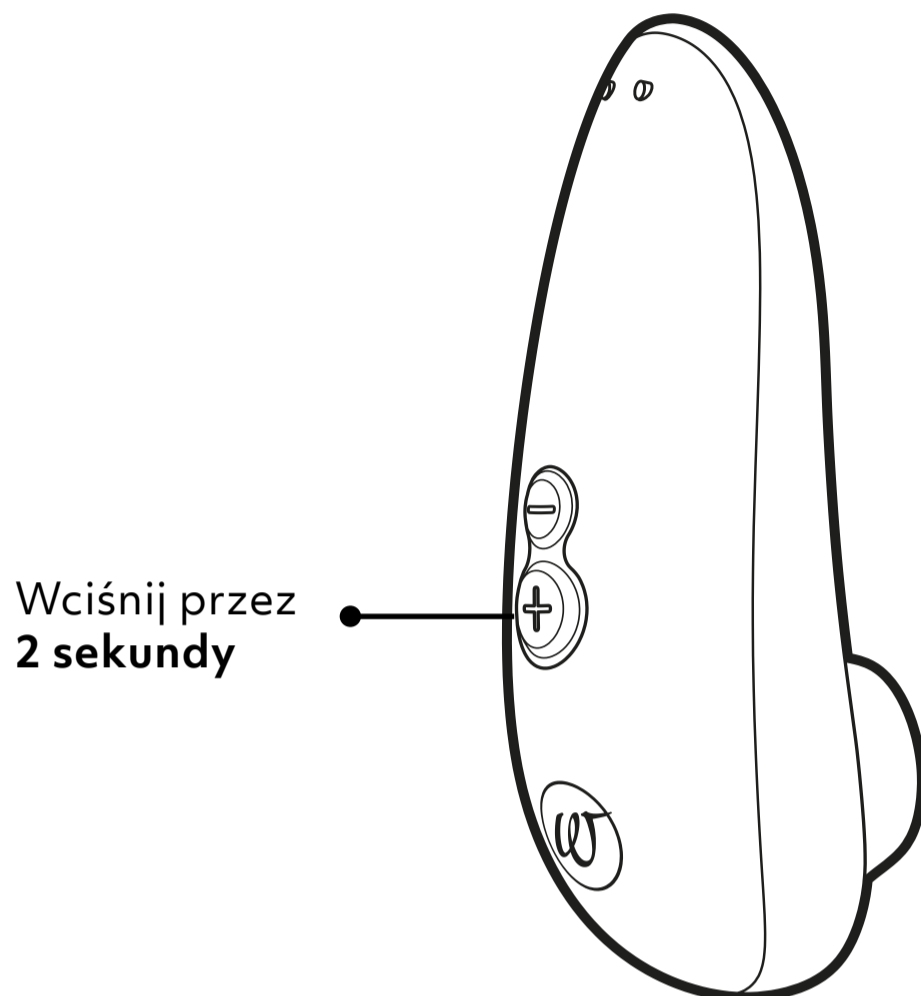

## 2. Użycie

Otocz swoją łechtaczkę główką stymulującą i Twoja podróż się zaczyna.

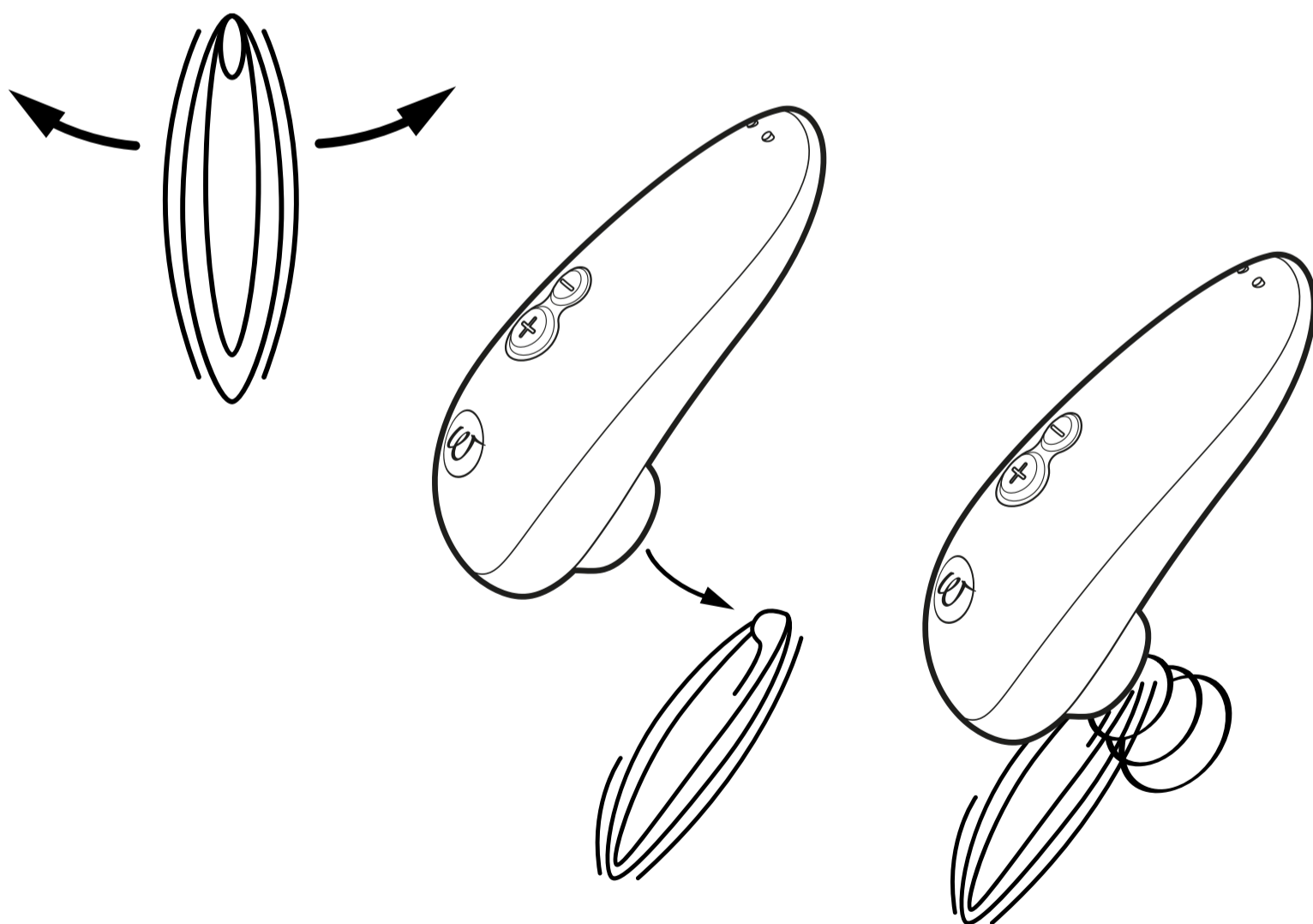

### 3. Zmiana intensywności

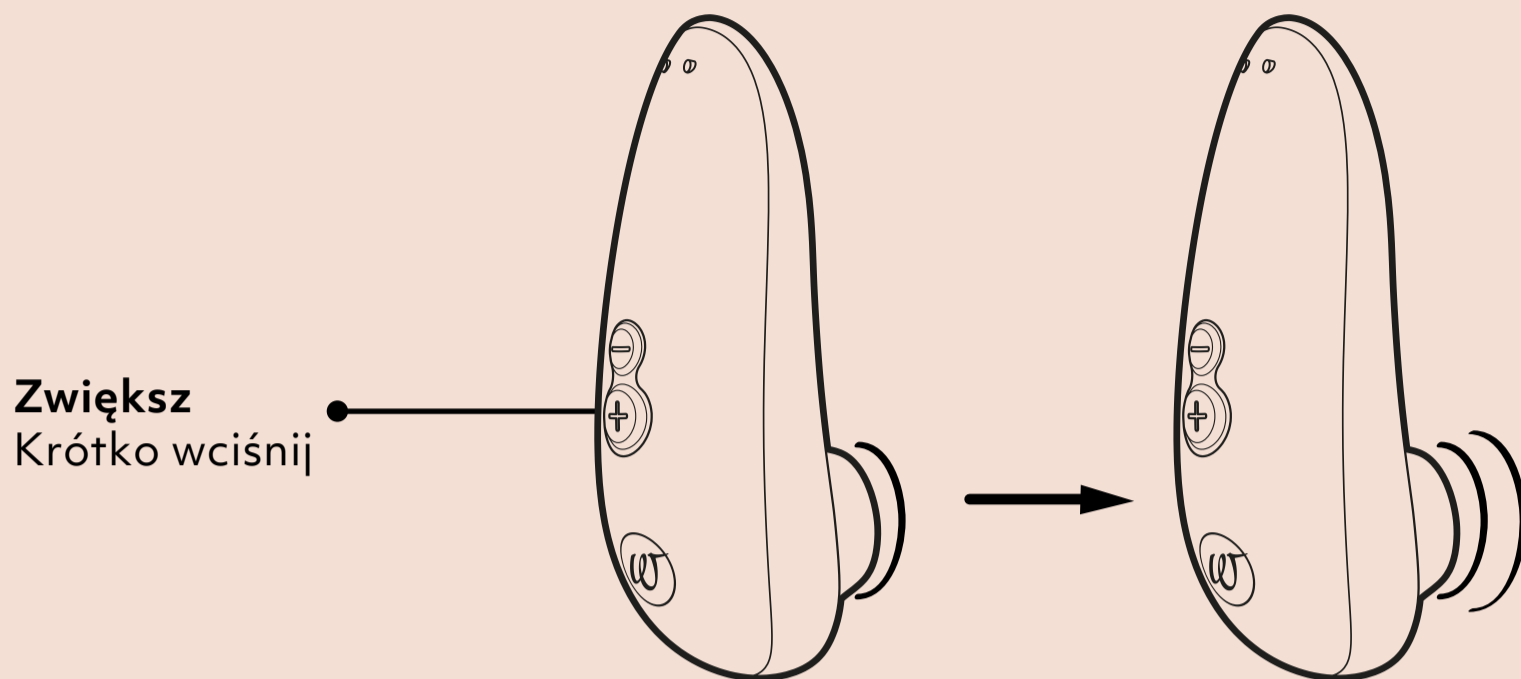

### 6 Poziomy intensywności

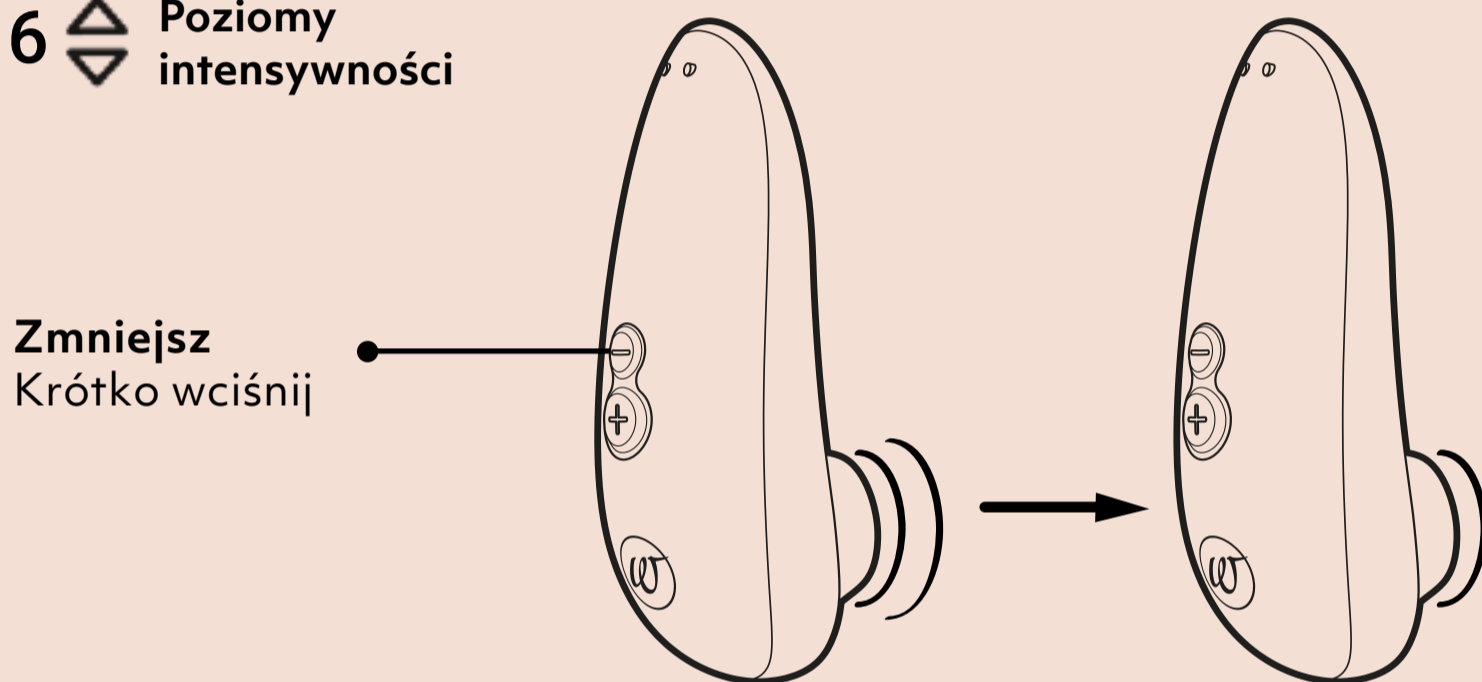

### 4. Wyłącz

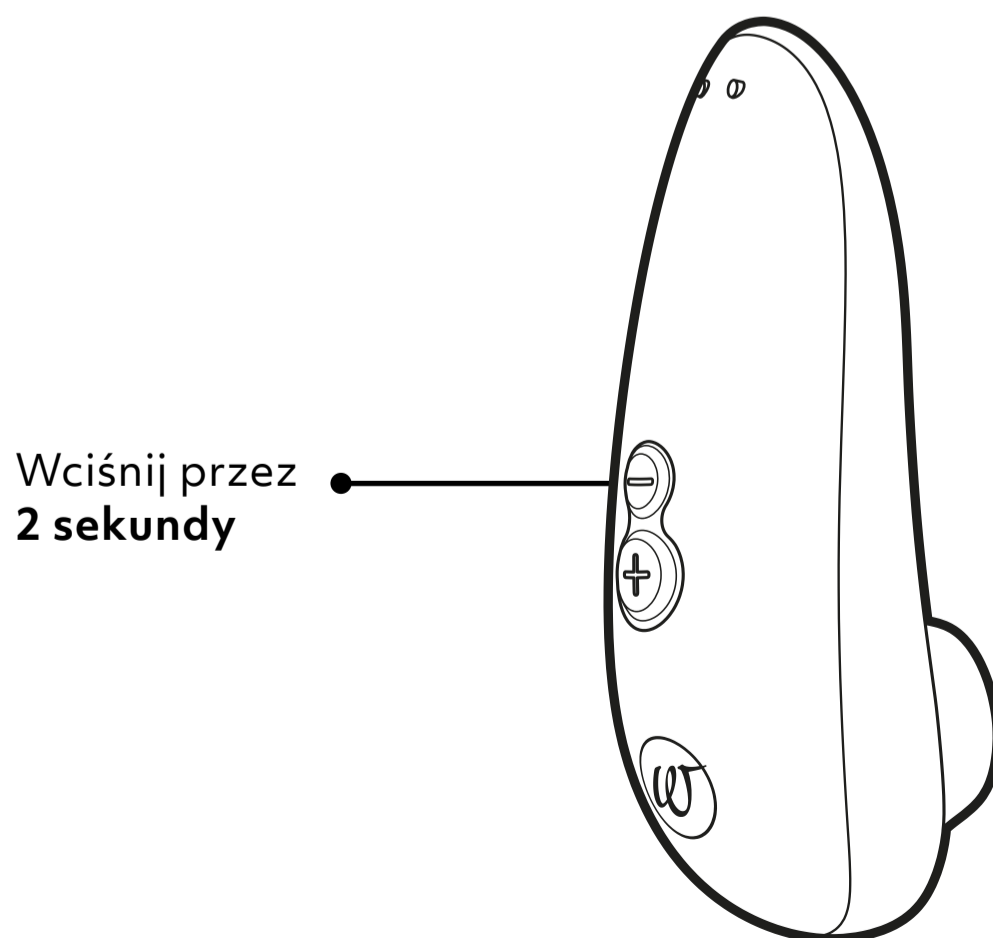

# ŁADOWANIE

Przed pierwszym użyciem całkowicie naładuj Womanizer.  
Pamiętaj również, aby regularnie ładować swój Womanizer, co zapewni długą żywotność akumulatora.

**Ładowanie**  
przez port USB

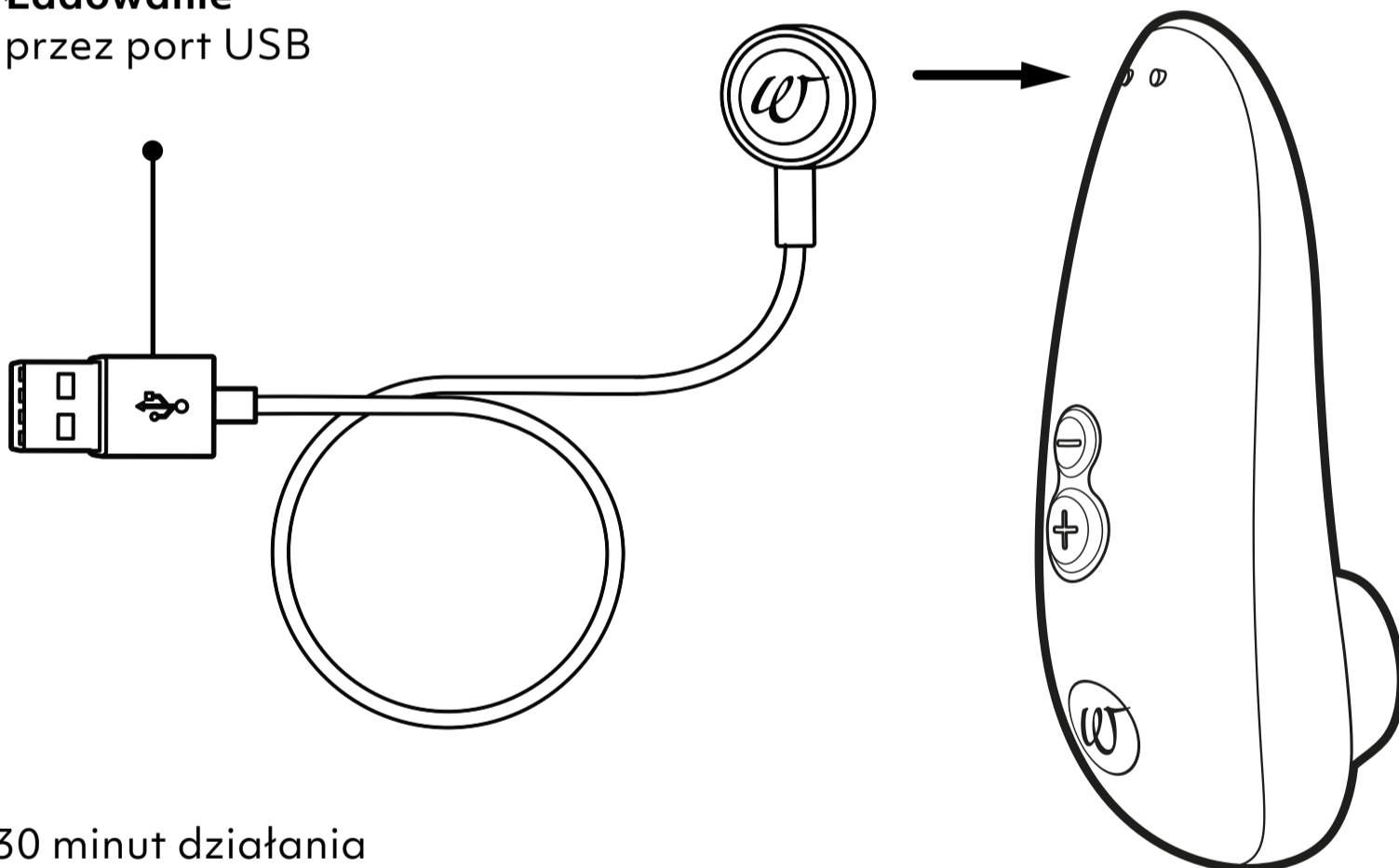

30 minut działania  
30 minut do pełnego naładowania

# CZYSZCZENIE

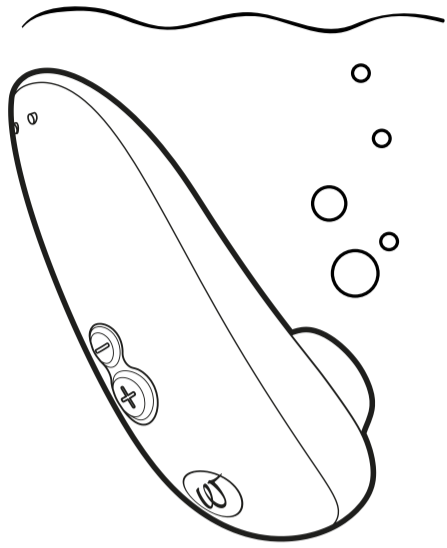

Umyj wodą

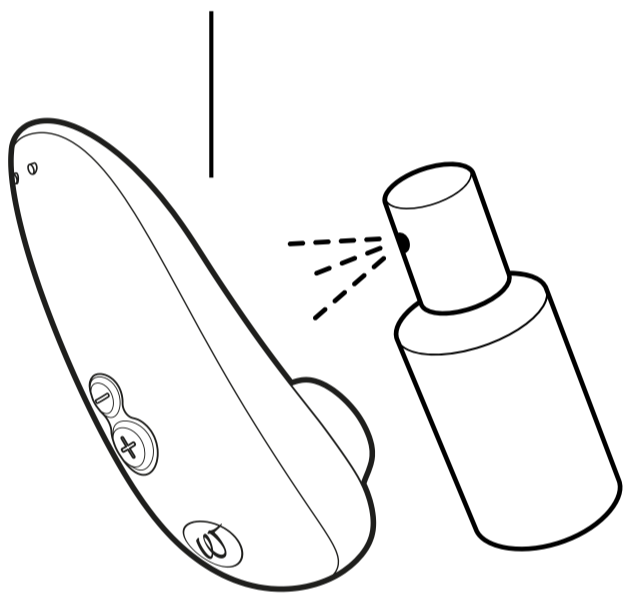

Używaj produktu do mycia zabawek

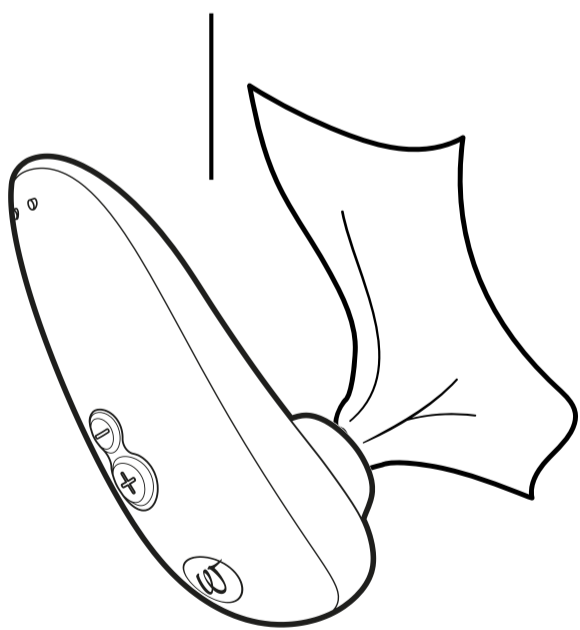

Osusz

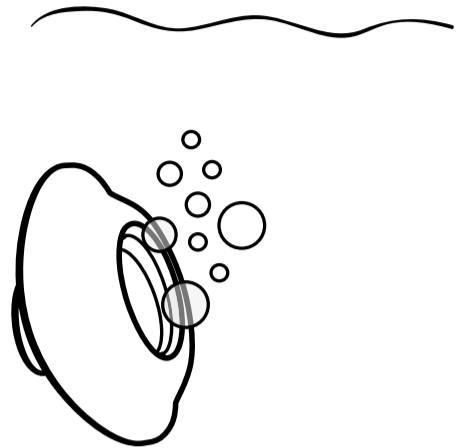

Umyj wodą

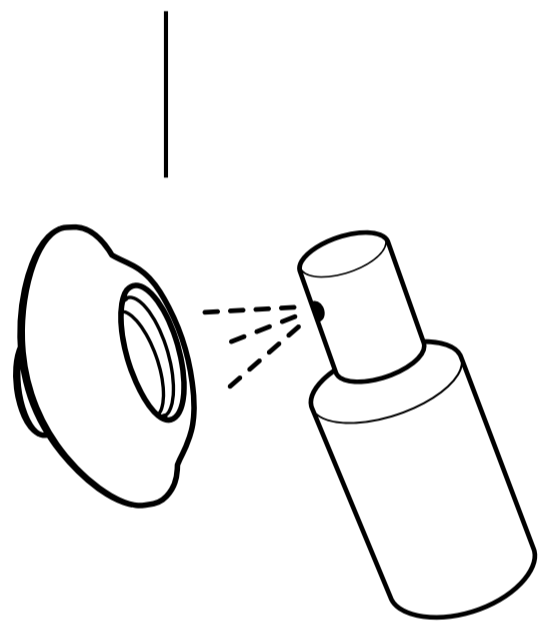

Używaj produktu do mycia zabawek

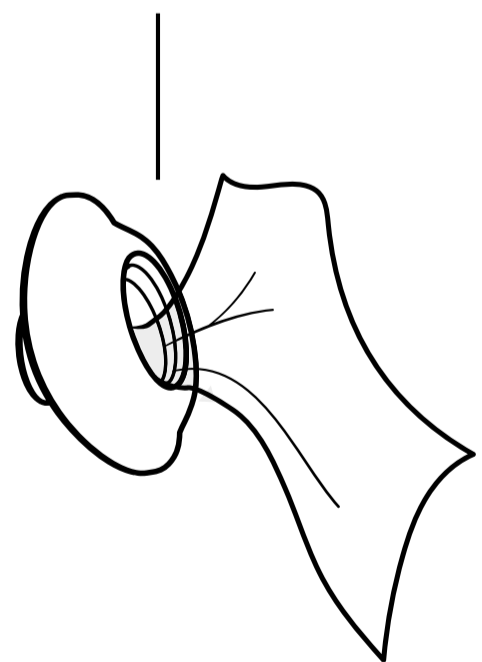

Osusz



Waterproof  
IPX7

# INFORMACJE OGÓLNE

## OSTRZEŻENIE

Podczas używania produktu Womanizer nie używaj perfumowanych lubrykantów na bazie alkoholu lub silikonu, żeli ani olejków do masażu, ponieważ grozi to jego uszkodzeniem. Przed pierwszym użyciem oraz po każdym kolejnym użyciu dokładnie umyj Womanizer, aby ograniczyć ryzyko infekcji.

## OBSŁUGA KLIENTA

Szczegółowe informacje znajdują się na naszej stronie [www.womanizer.com](http://www.womanizer.com), można również skontaktować się z nami pod adresem [care@womanizer.com](mailto:care@womanizer.com).

## SPECYFIKACJA TECHNICZNA

Model: WZ15B

Parametry elektryczne: 3,7 V=0,135 A:  
Wbudowany akumulator litowo-jonowy.

5 V=0,75 A: Ładowanie przez USB.

Ładowarka:

Zasilacz sieciowy USB (nie zawarty w zestawie) o mocy wyjściowej odpowiadającej parametrom elektrycznym urządzenia. Nie używaj ładowarki szybkiego ładowania.

## SKŁADNIKI ZESTAWU

Womanizer Starlet 3, przewód USB do ładowania, skrócona instrukcja obsługi, instrukcja bezpieczeństwa.

## PRZECHOWYWANIE

Urządzenie przechowuj w zabezpieczonym, suchym miejscu, nie narażonym na bezpośrednie nasłonecznienie.

## GWARANCJA ORAZ DODATKOWA GWARANCJA PRODUCENTA

Oprócz standardowej ustawowej gwarancji, WOW TECH EUROPE GMBH udziela na ten produkt dodatkowej, dobrowolnej gwarancji producenta. Warunki dodatkowej gwarancji producenta są zamieszczone w naszej witrynie internetowej w sekcji „Warunki gwarancji”.

## ZGODNOŚĆ Z NORMAMI

Niniejsze urządzenie jest zgodne z wszelkimi normami w zakresie kompatybilności elektromagnetycznej (EMC). Urządzenie jest bezpieczne w użyciu pod warunkiem, że jest stosowane w sposób poprawny, zgodnie z instrukcją obsługi.

## OCHRONA ŚRODOWISKA

Jako dystrybutor urządzeń elektronicznych, jesteśmy prawnie zobowiązani do bezpłatnego przyjęcia zwrotu zużytego sprzętu elektrycznego i elektronicznego. Podkreślamy, że jako użytkownik masz prawny obowiązek zwrotu zużytych baterii/akumulatorów. Nigdy nie wyrzucaj urządzeń elektronicznych ani baterii/akumulatorów do odpadów komunalnych. Poniższy symbol, który znajduje się również na naszych urządzeniach elektronicznych, ma na celu wyraźne przypomnienie o tym zakazie.

## DYSTRYBUTOR

WOW Tech Europe GmbH,  
Friedenstrasse 91 / 91 a, 10249 Berlin, Niemcy

WOW Tech Europe GmbH zastrzega sobie prawo do wprowadzenia zmian technicznych oraz w projekcie urządzenia, które mają na celu jego udoskonalenie.

Dystrybutor w Ameryce Północnej:  
WOW TECH Canada Ltd. 1545 Carling Avenue, Suite 401, Ottawa ON, Canada K1Z 8P9

[www.wowtech.com](http://www.wowtech.com) Zaprojektowano w Niemczech. Wyprodukowano w Chinach w 2021 r. Data wydania instrukcji: 02/2021. Wersja 1.

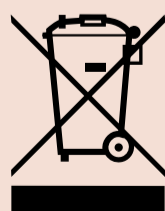



# WCIĄŻ PRAGNIESZ WIĘCEJ?

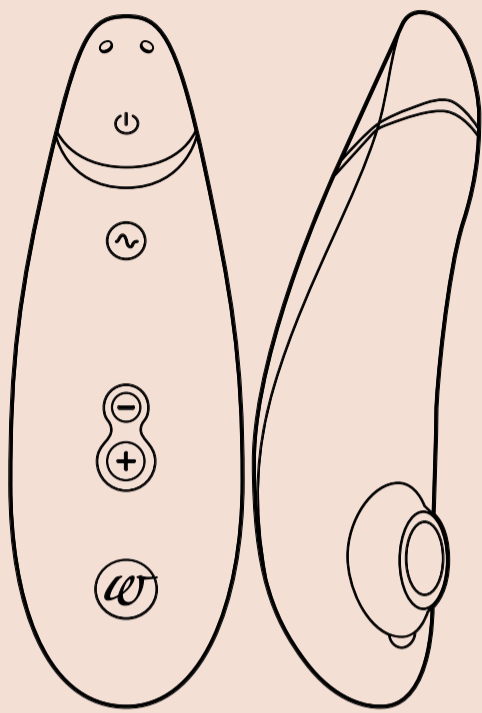

**Pleasure Air  
Technology**



**Smart Silence**

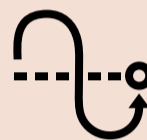

**Autopilot**

**Premium 2**  
Define your luxury

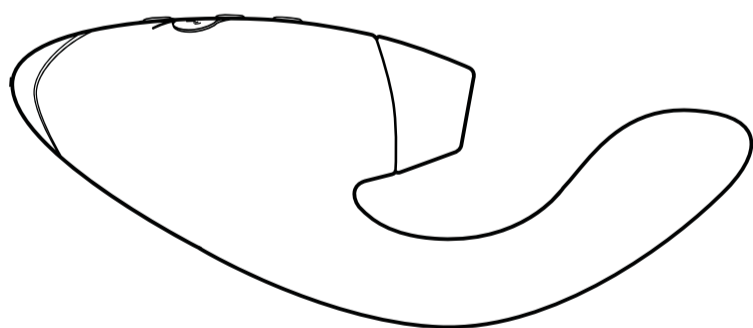

**Pleasure Air  
Technology**



**Vibrator**



**Smart Silence**

**DUO**  
Double your Pleasure



**#IMASTURBATE**

# Hej!

**Tack för att du valde Womanizer!**

Välkommen till en värld av sensuella upplevelser som kommer att berika ditt liv. Genom att välja WOMANIZER garanteras du inte bara ojämförbara orgasmer – utan även en helt ny lust till njutning.

**Njut av din WOMANIZER – en orgasm i taget.**

Älska dig själv!



**PRODUKT BESKRIVNING**

**ANVÄNDNING**

**LADDNING**

**RENGÖRING**

**ALLMÄN INFORMATION**

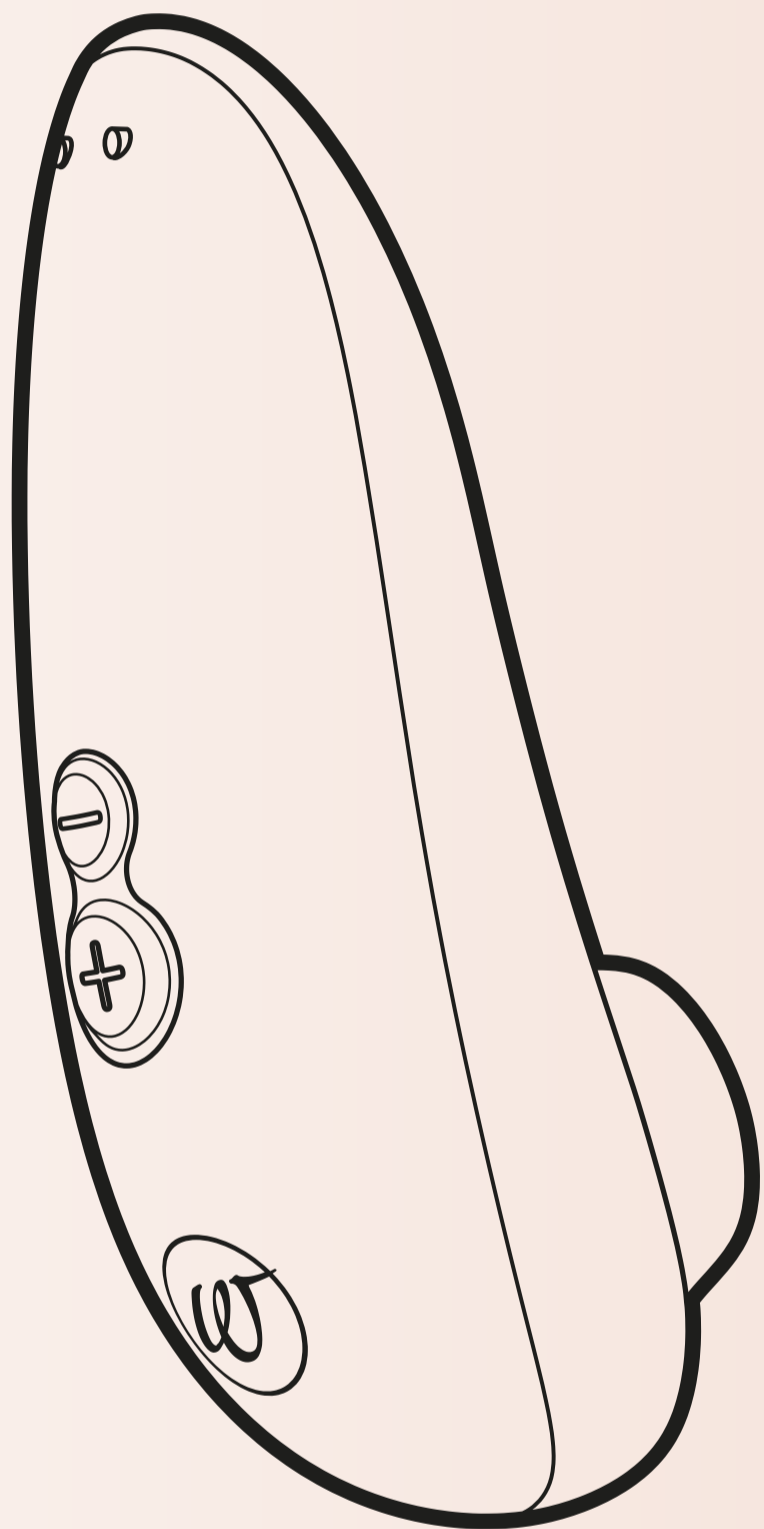

# PRODUKTBESKRIVNING

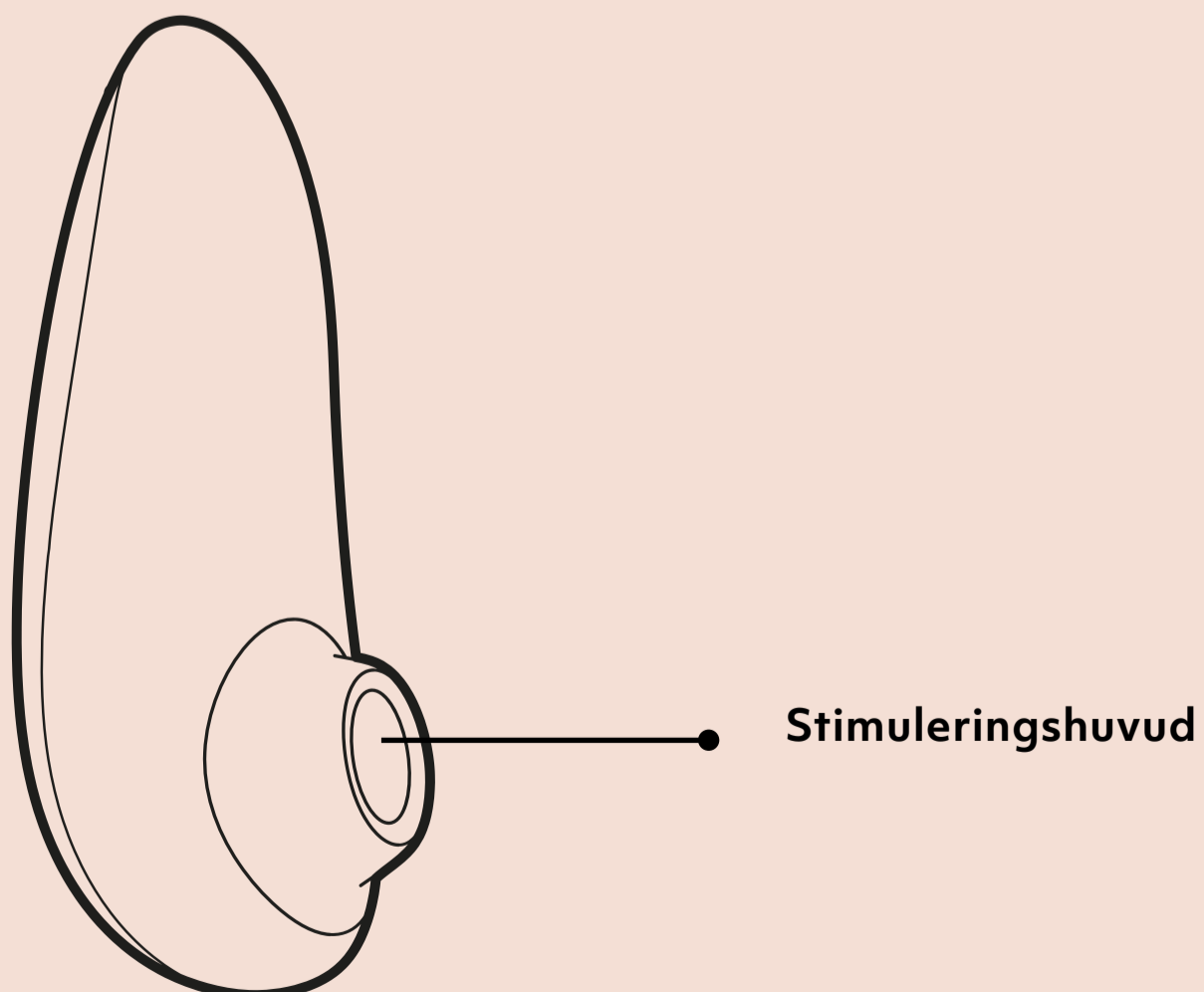
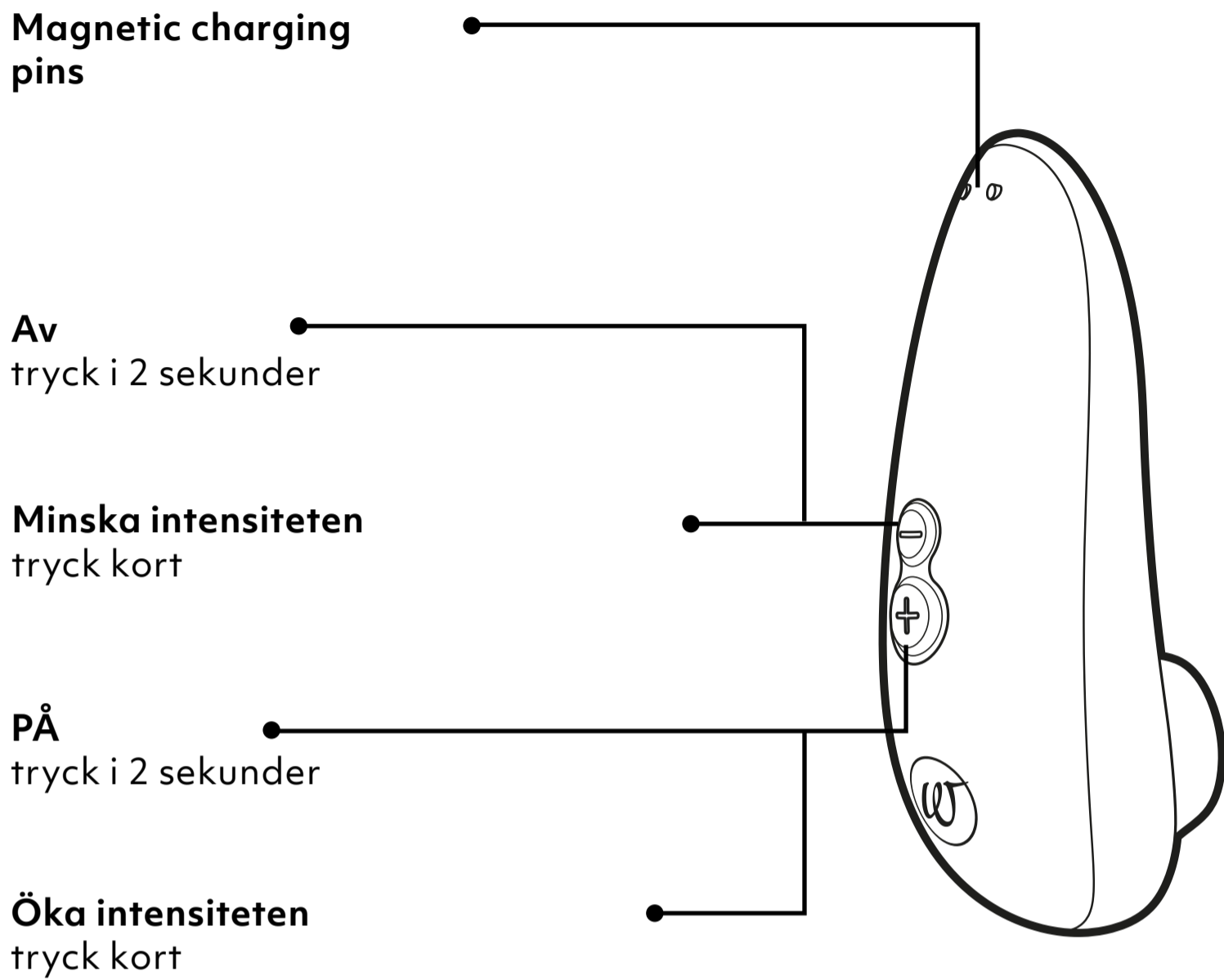

# ANVÄNDNING

## 1. Slå på

Tryck i  
2 sekunder

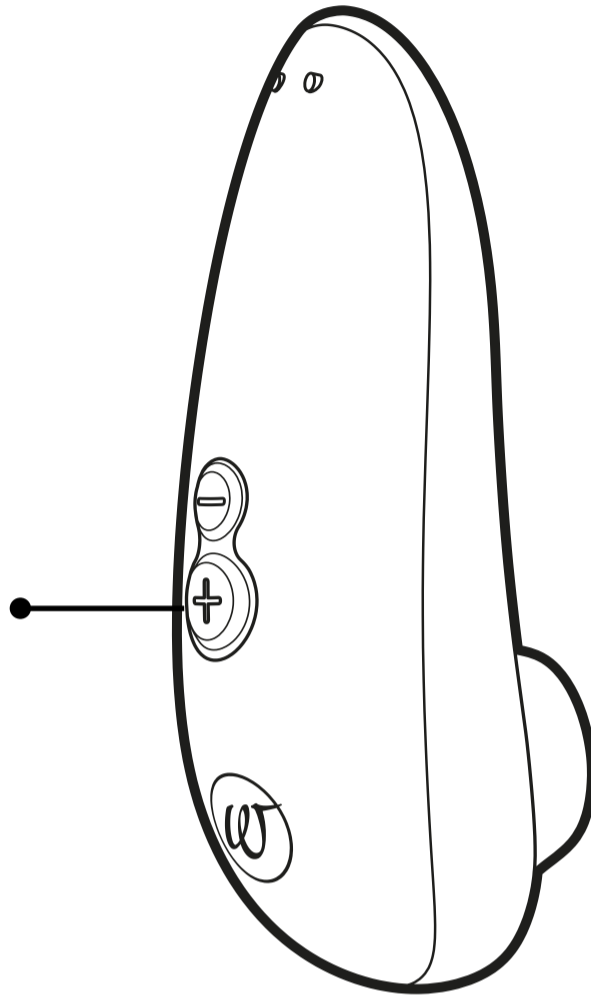

## 2. Användning

Låt stimuleringsmunstycket omsluta klitoris och påbörja din resa.

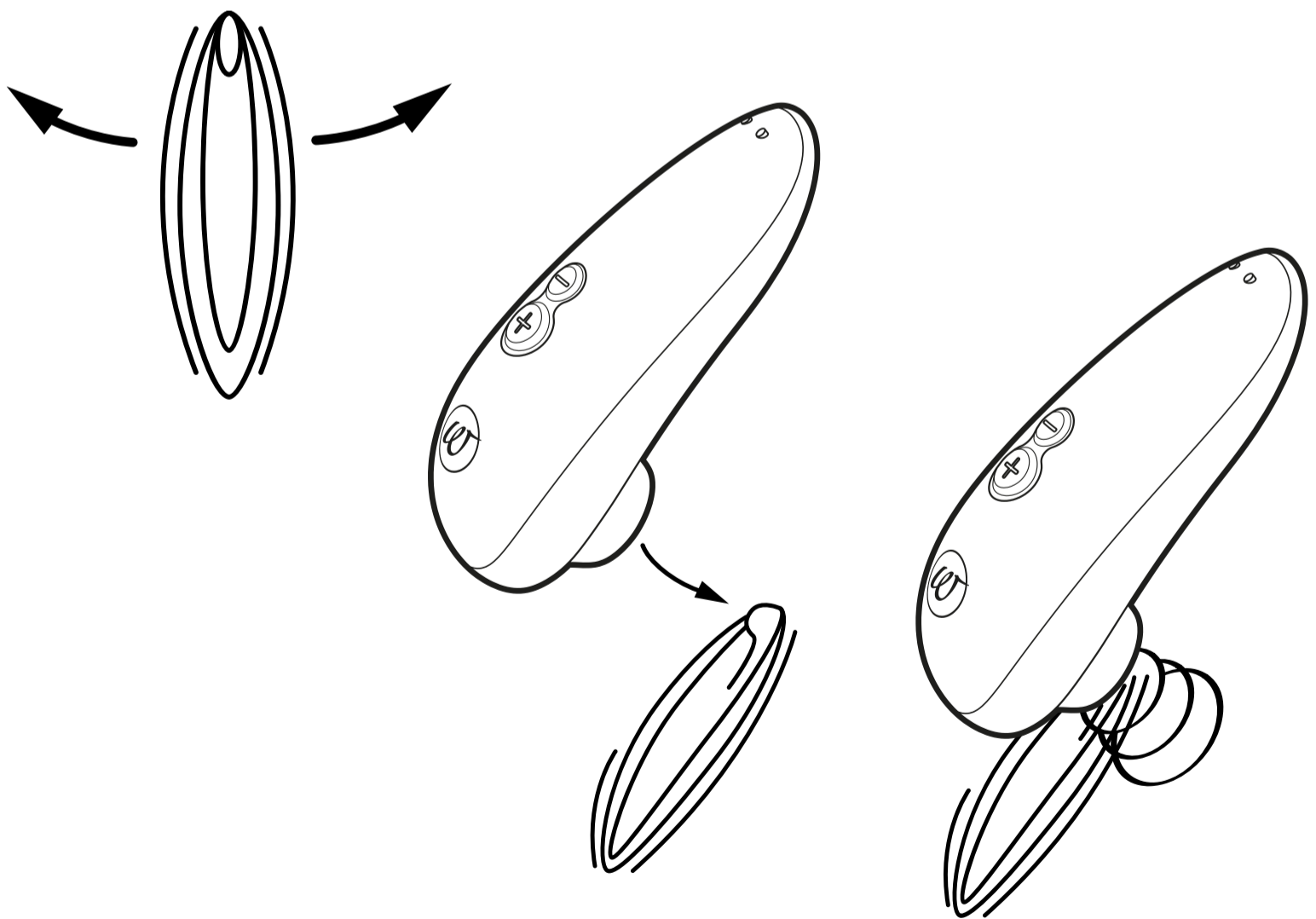

### 3. Ändra styrka

Öka  
tryck kort

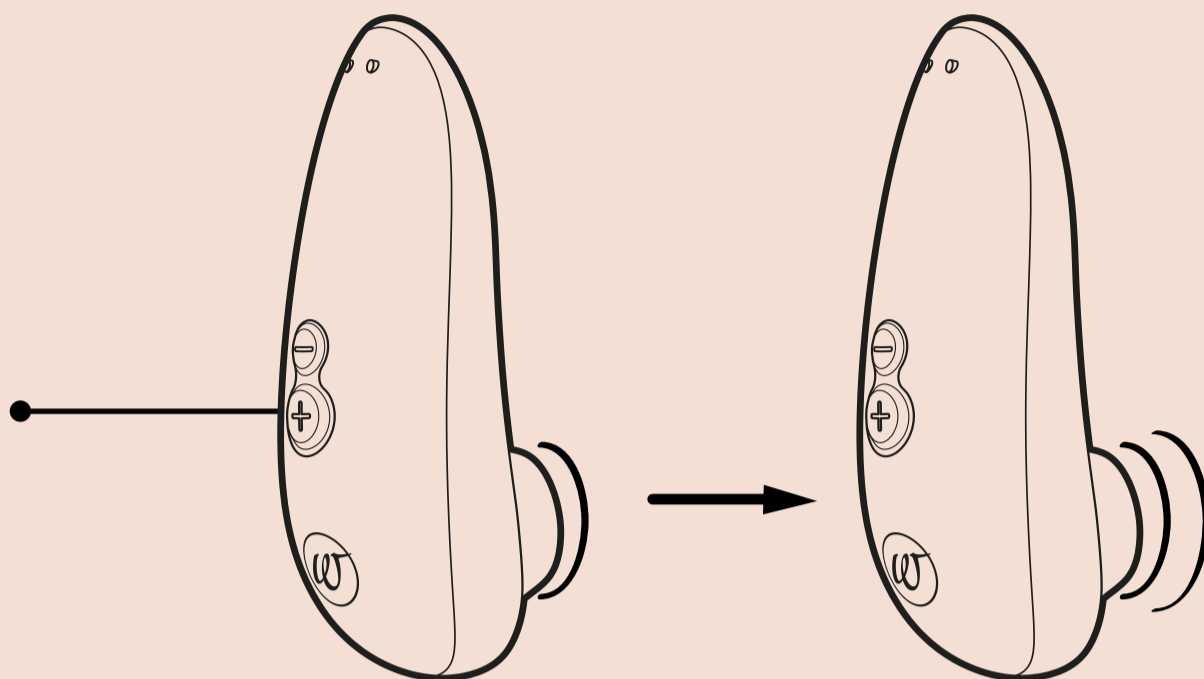

6  Intensitets  
nivåer

Minska  
tryck kort

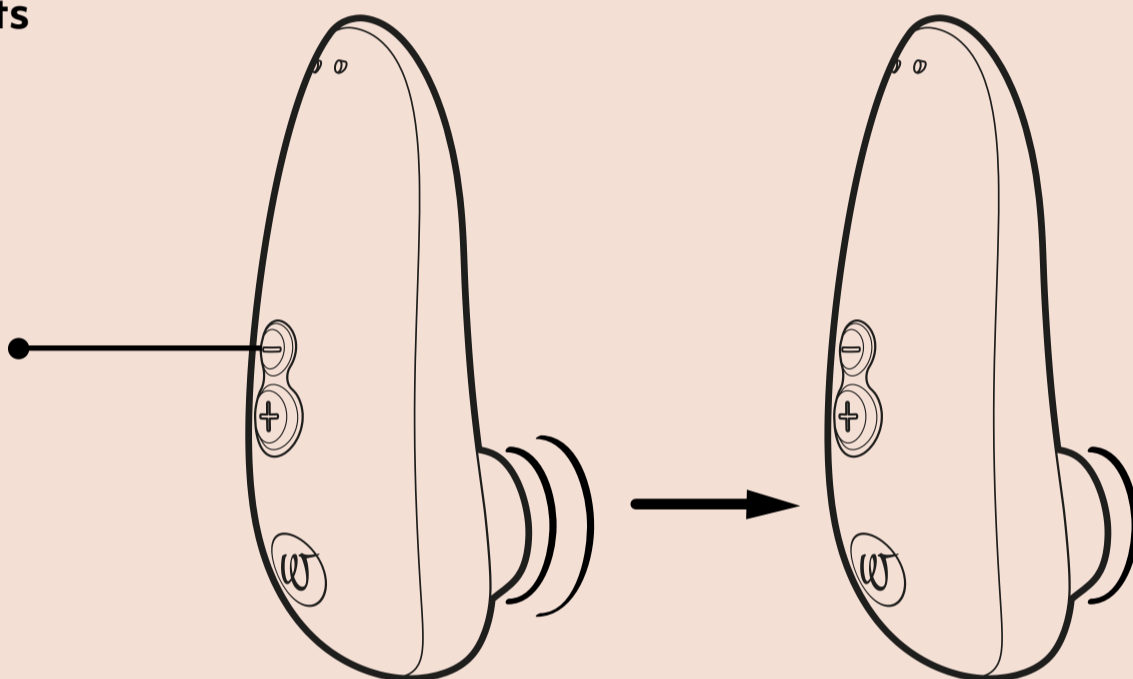

### 4. Stäng av

tryck i  
2 sekunder

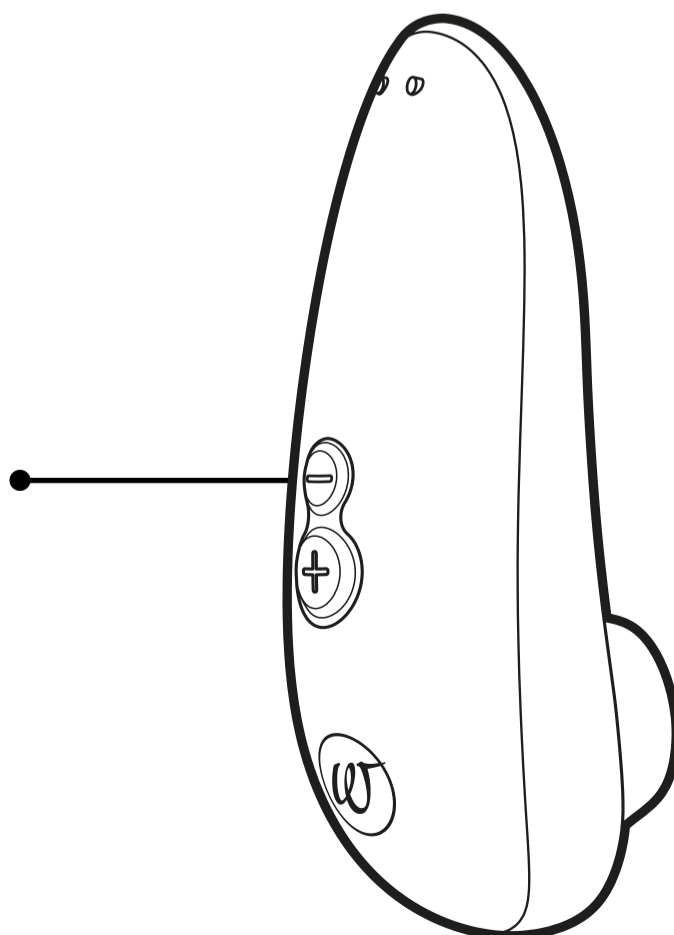



# LADDNING

Ladda din Womanizer innan du använder den för första gången. Tänk även på att ladda din Womanizer regelbundet för att säkerställa att batteriet håller länge.

**Laddning**  
via USB-port

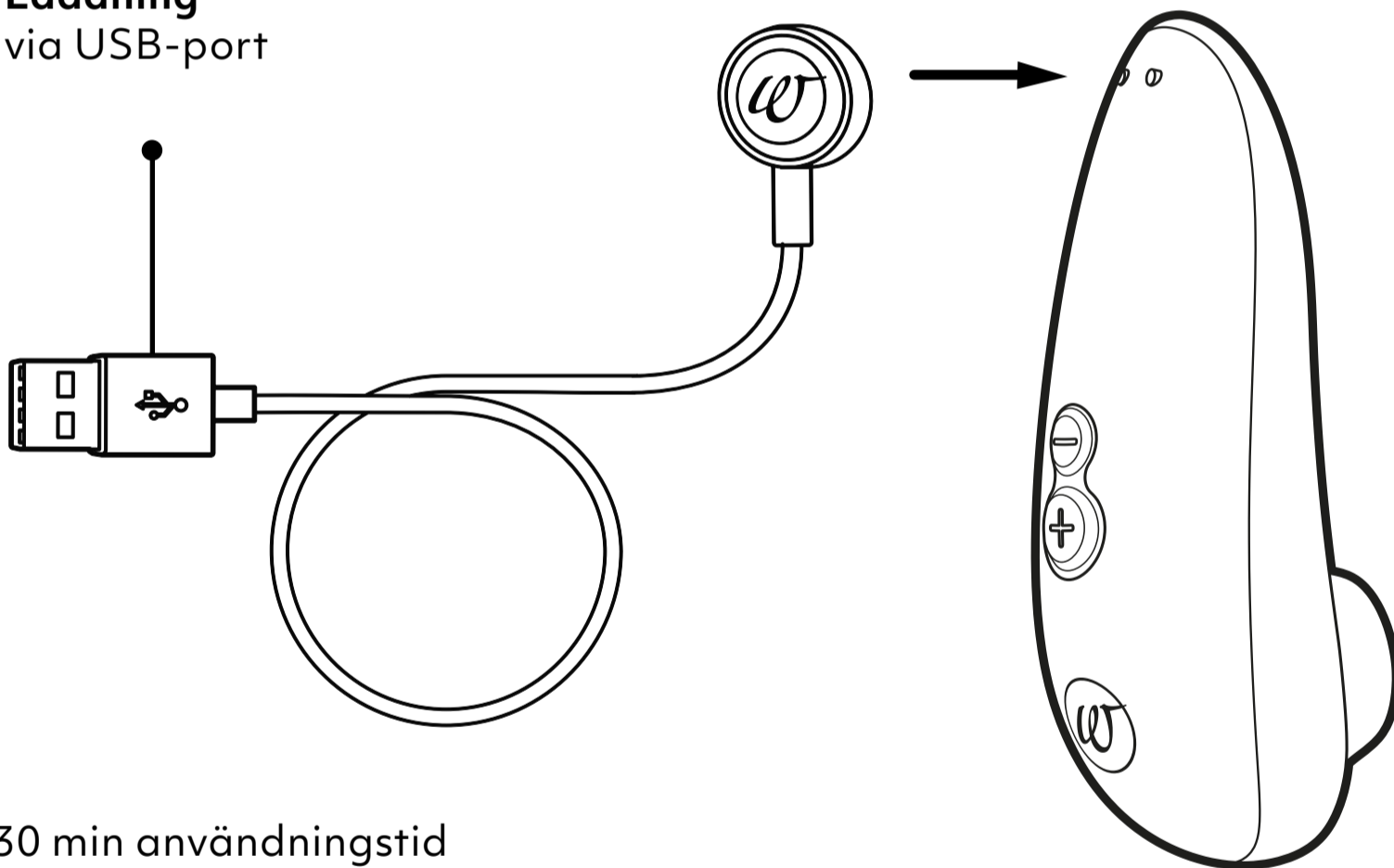

30 min användningstid  
30 min för full laddning

# RENGÖRING

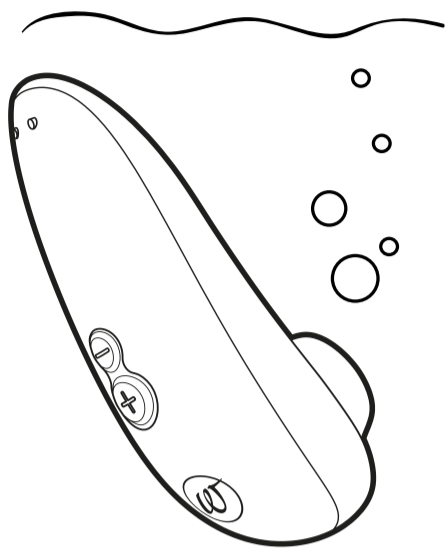

rengör under  
vatten

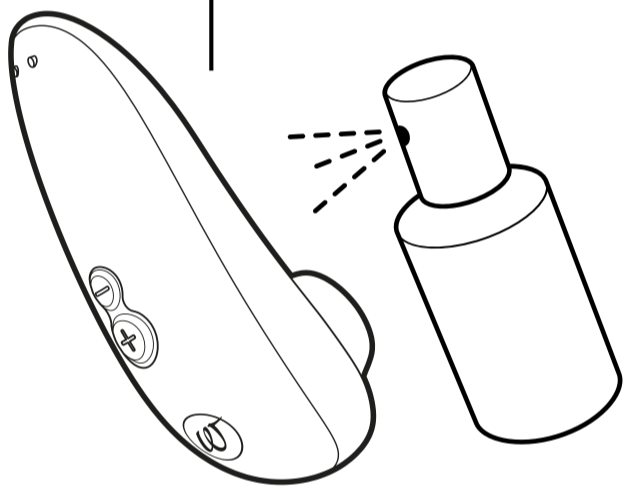

Använd rengöring  
för leksaker

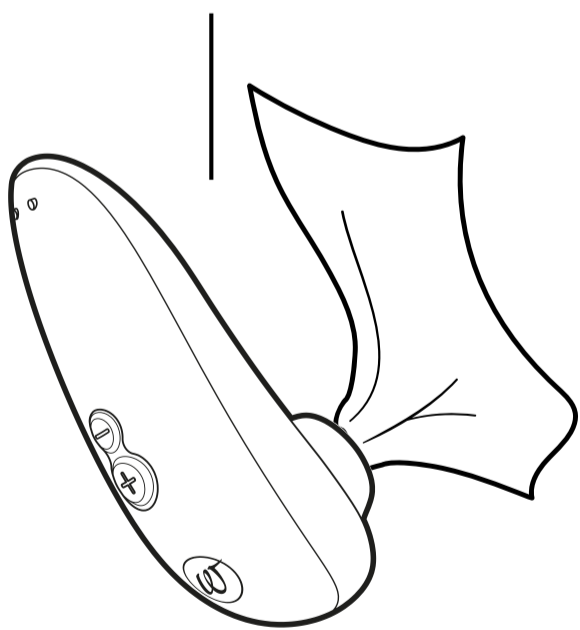

Torka

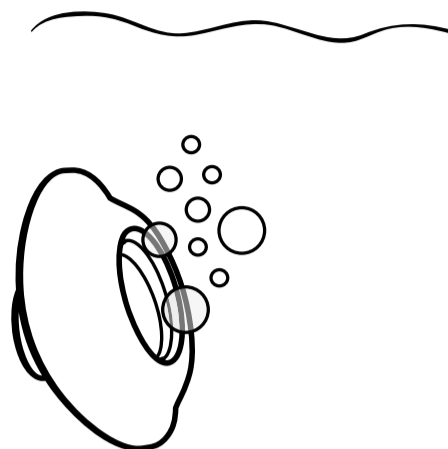

rengör under  
vatten

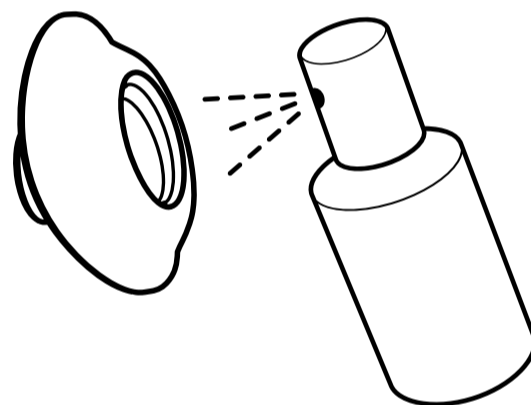

Använd rengöring  
för leksaker

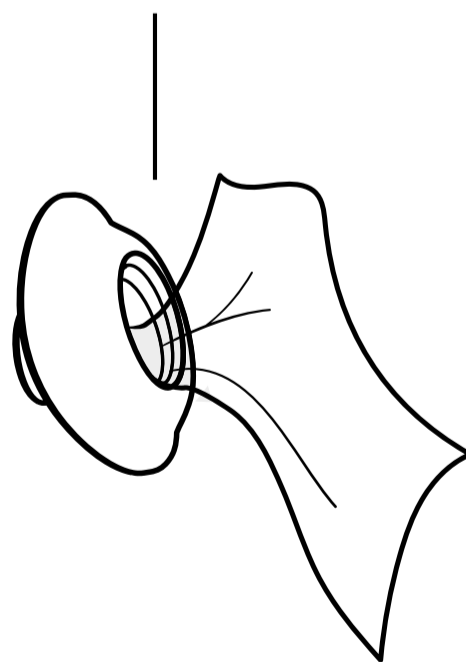

Torka



Waterproof  
IPX7

# ALLMÄN INFORMATION

## VARNING

Använd inte parfymerade, alkohol- eller silikonbaserade glidmedel, massageoljor när du använder Womanizer eftersom det kan skada apparaten. Rengör din Womanizer noggrant före första användningen och efter varje användning för att minska infektionsrisken.

## KUNDTJÄNST

För mer information, gå till [www.womanizer.com](http://www.womanizer.com) eller skriv till [care@womanizer.com](mailto:care@womanizer.com).

## TEKNISKA SPECIFIKATIONER

Modell: WZ15B

Effektklass: 3,7  $\approx$  0,135 A:

Inbyggt uppladdningsbart litiumjonbatteri.

5 V  $\approx$  0,75 A: Vid laddning med USB.

Laddningsenhet:

USB-nätadapter (ingår ej) med effekt som motsvarar produktklassen. Använd inte snabb-laddningsadapter.

## LEVERANSOMFÅNG

Womanizer Starlet 3, USB-laddningskabel, snabbstartsguide, säkerhetsinstruktioner.

## FÖRVARING

Förvara på en säker, torr plats skyddad mot direkt solljus.

## GARANTI OCH FRIVILLIG TILLVERKARGARANTI

WOW TECH EUROPE GMBH ger kunderna en frivillig tillverkargaranti för den här produkten i tillägg till den obligatoriska garanti som kunder har rätt till gentemot säljare.

Villkoren för tillverkarens frivilliga garanti finns att läsa på vår webbplats under rubriken "Warranty Conditions".

## UPPFYLLENDE AV NORMER

Denna apparat uppfyller alla normer för elektromagnetisk kompatibilitet (EMC). Apparaten är säker att använda så länge den används korrekt och i enlighet med instruktionerna i denna bruksanvisning.

## MILJÖSKYDD

Som distributör av elektroniska apparater är vi juridiskt skyldiga att ta emot restavfall av elektriska och elektroniska apparater utan kostnad. Vi anger uttryckligen att du som användare är juridiskt skyldig att returnera begagnade batterier. Kasta aldrig elektrisk utrustning eller batterier i hushållsavfallet.

Symbolen som visas nedan, och som även finns på våra elektriska apparater, ska påminna om detta.

## LEVERANTÖR

WOW Tech Europe GmbH,  
Friedenstrasse 91 / 91 a, 10249 Berlin, Tyskland

WOW Tech Europe GmbH förbehåller sig rätten att göra tekniska ändringar och ändringar i designen med syfte att förbättra apparaten.

Distribueras i Nordamerika av WOW TECH Canada Ltd. 1545 Carling Avenue, Suite 401, Ottawa ON, Kanada K1Z 8P9

[www.wowtech.com](http://www.wowtech.com) Formgiven i Tyskland. Tillverkad i Kina 2021. Manual utgiven 2021-02. Version 1.

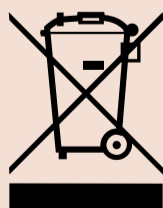

# VILL DU HAMMER?

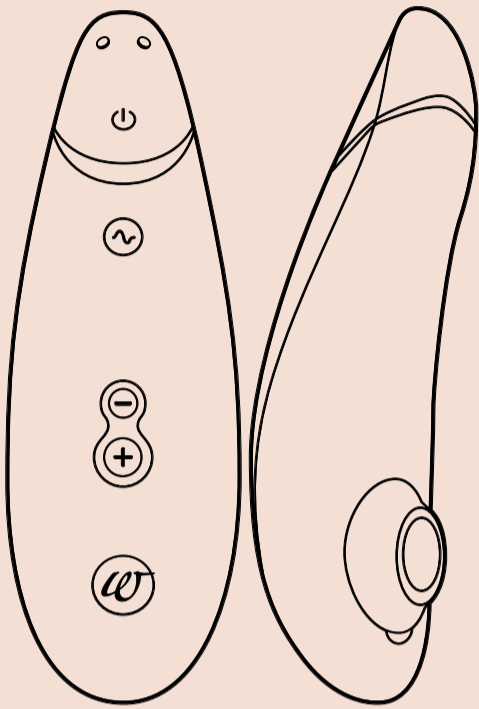

**Pleasure Air  
Technology**



**Smart Silence**

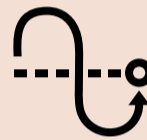

**Autopilot**

## **Premium 2**

Define your luxury

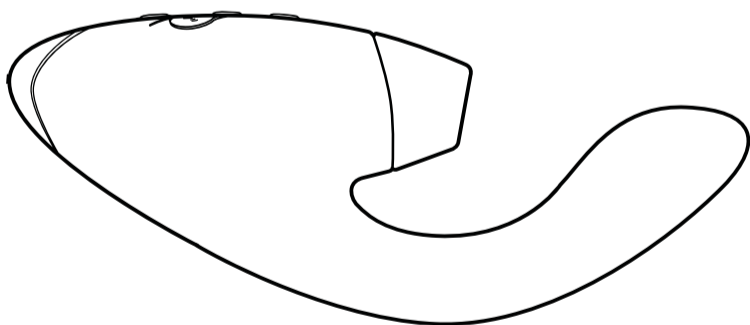

**Pleasure Air  
Technology**



**Vibrator**



**Smart Silence**

## **DUO**

Double your Pleasure



**#IMASTURBATE**

# Olá!

**Obrigado por escolheres o Womanizer!**

Bem-vinda a um mundo cheio de experiências sensuais que irão enriquecer a tua vida. Ao escolheres o WOMANIZER, garantes não só orgasmos sem comparação - mas também um desejo inteiramente novo no que respeita ao prazer.

**Goza o teu WOMANIZER - um orgasmo após o outro.**

Força, ama-te a ti própria!



**DESCRIÇÃO DO PRODUTO**

**COMO USAR**

**CARREGAR**

**LIMPEZA**

**INFORMAÇÃO GERAL**

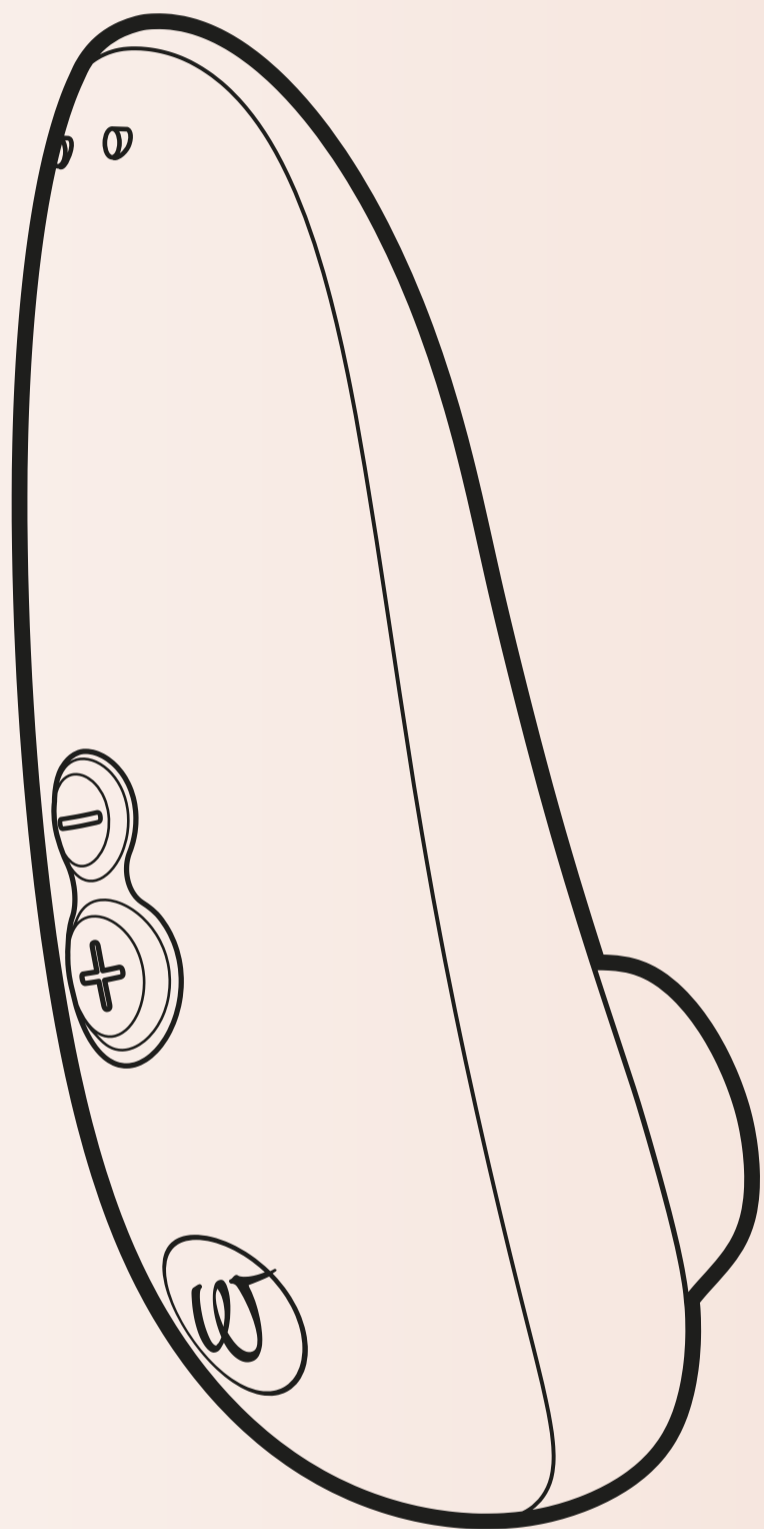



# DESCRIÇÃO DO PRODUTO

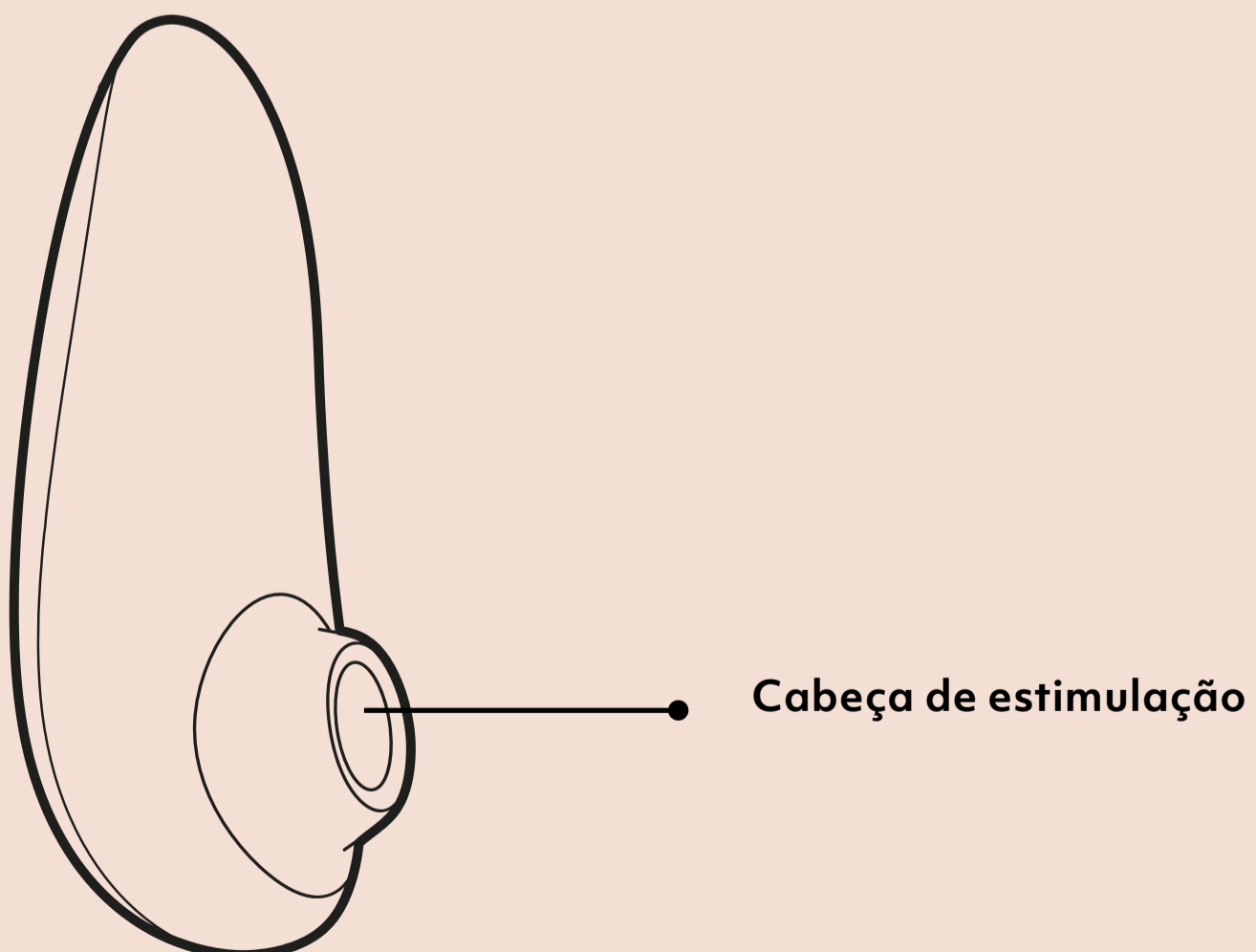
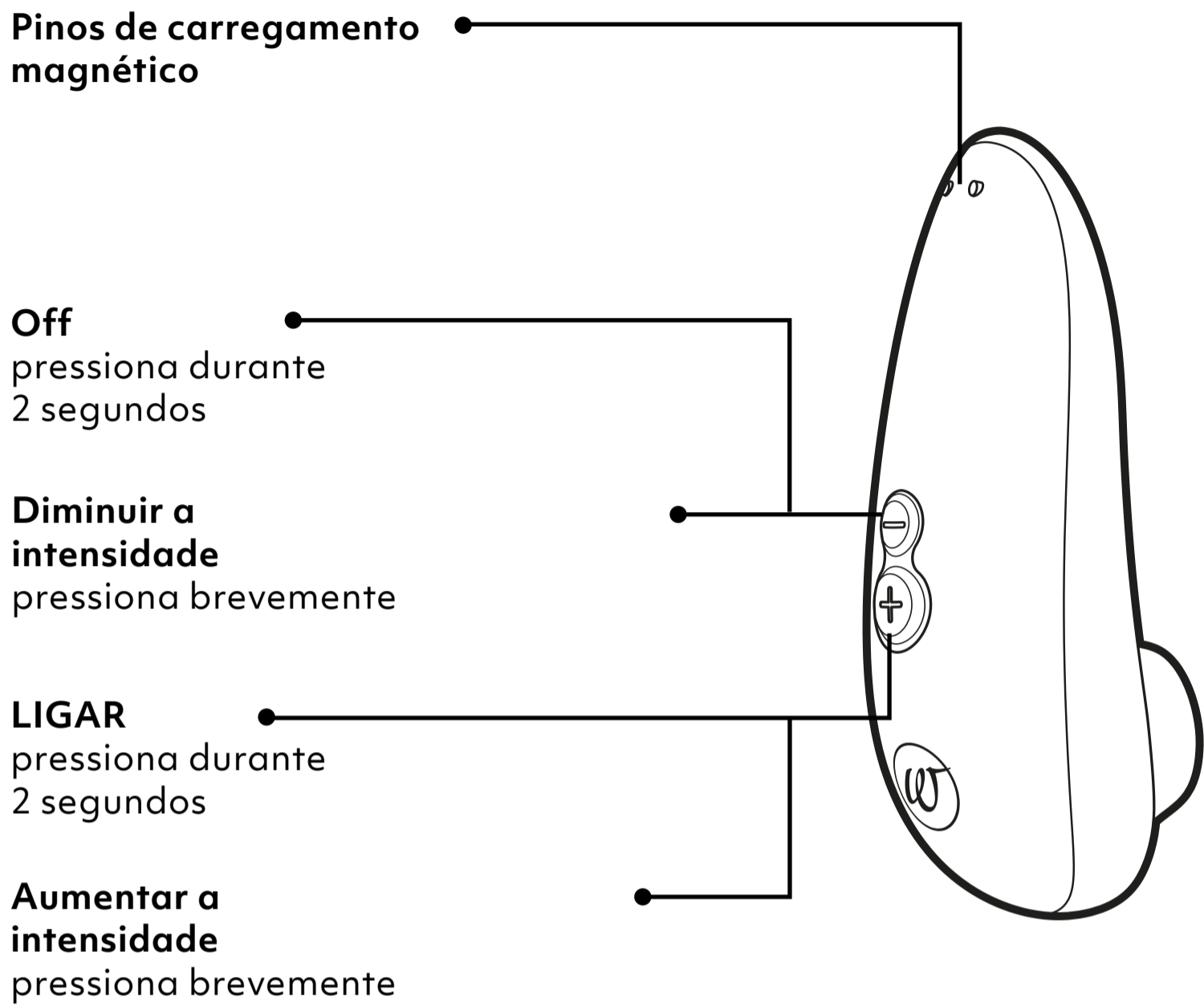

# COMO USAR

## 1. Ligar

Pressiona  
durante  
2 segundos

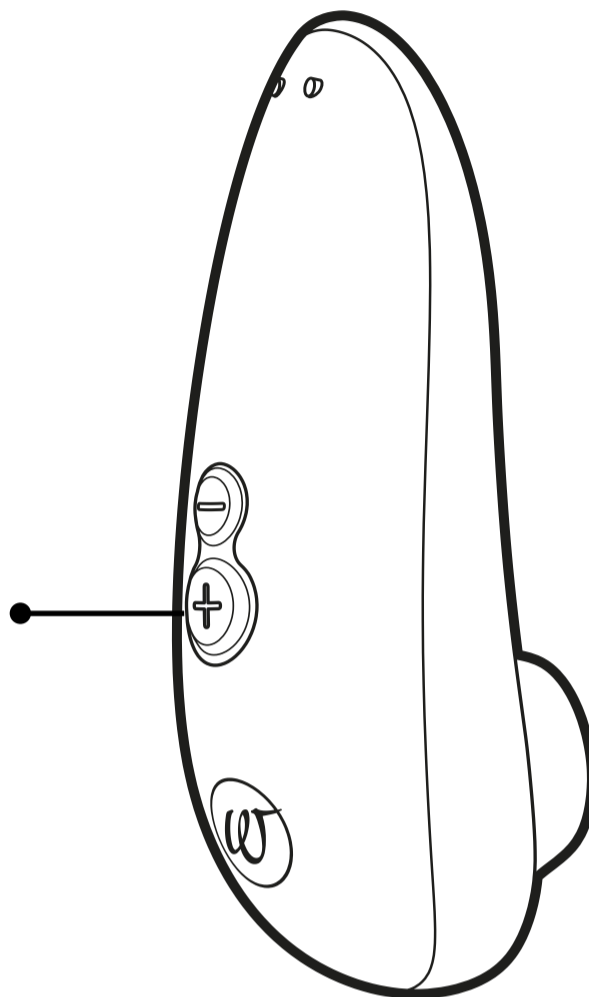

## 2. Utilização

Cobre o teu clítoris com a cabeça de estimulação e a tua viagem começa.

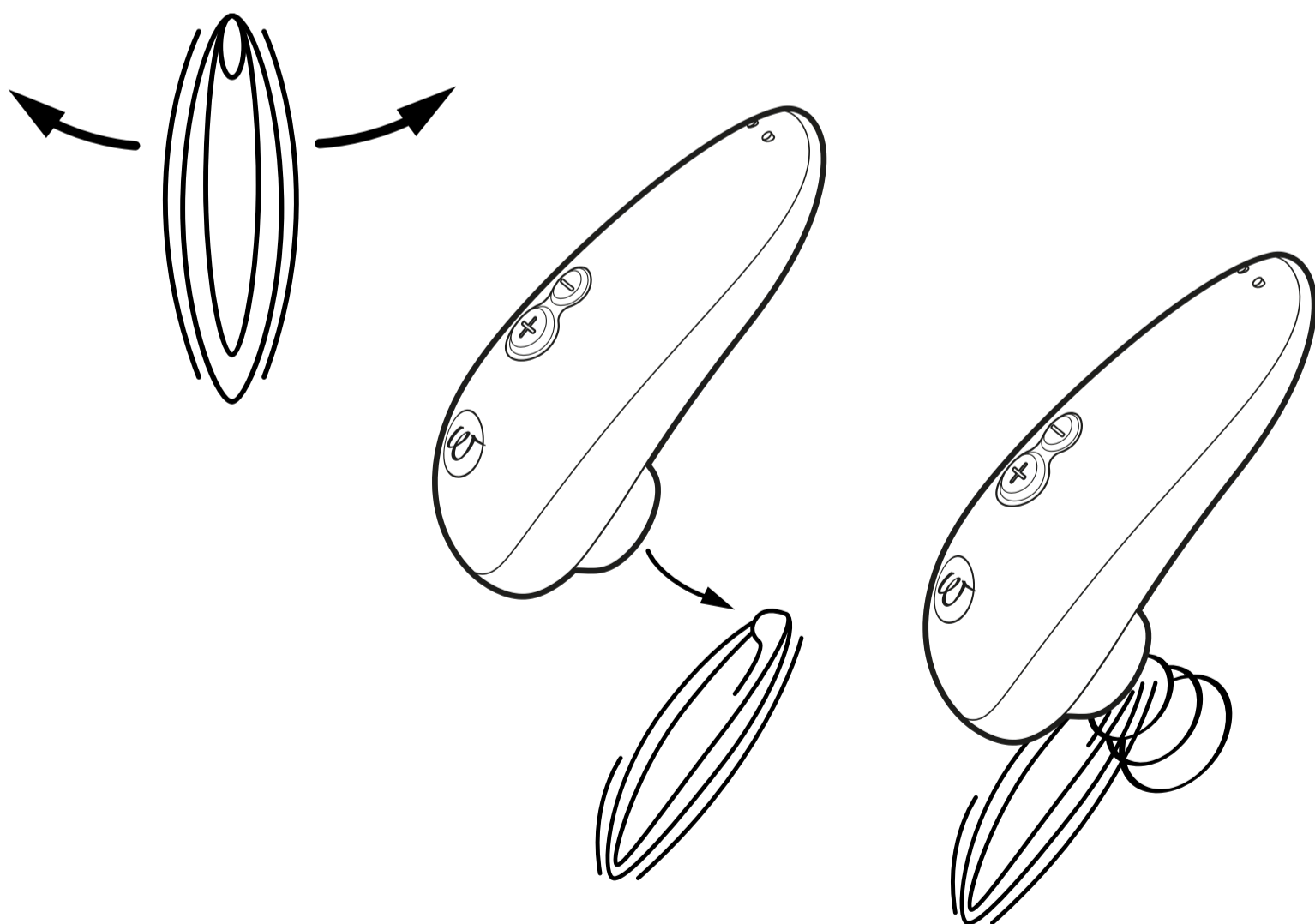

### 3. Mudar a intensidade

**Aumentar**  
pressiona  
brevemente

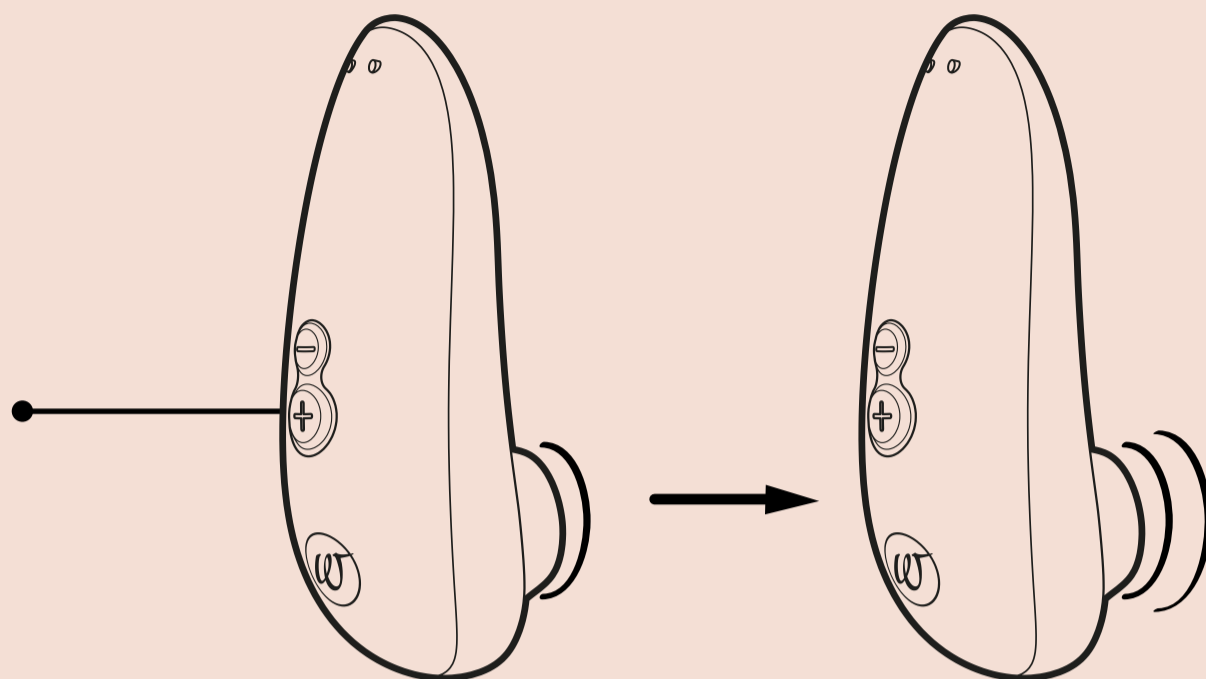

**6**  Níveis de  
intensidade

**Diminuir**  
pressiona  
brevemente

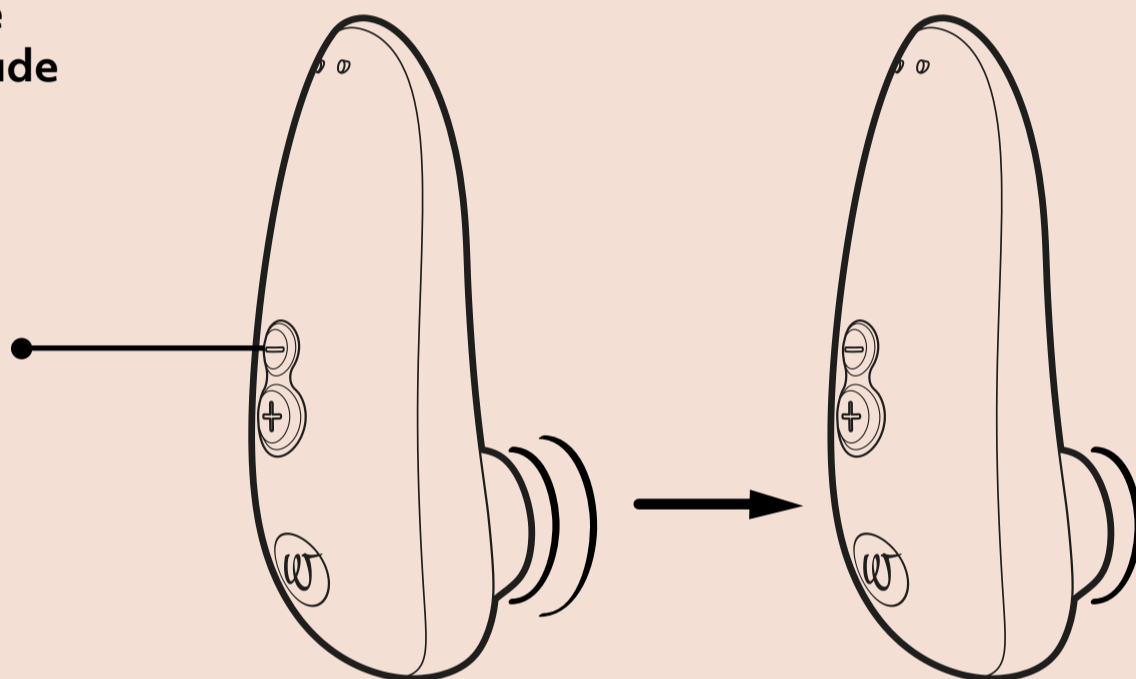

### 4. Desligar

pressiona  
durante  
**2 segundos**

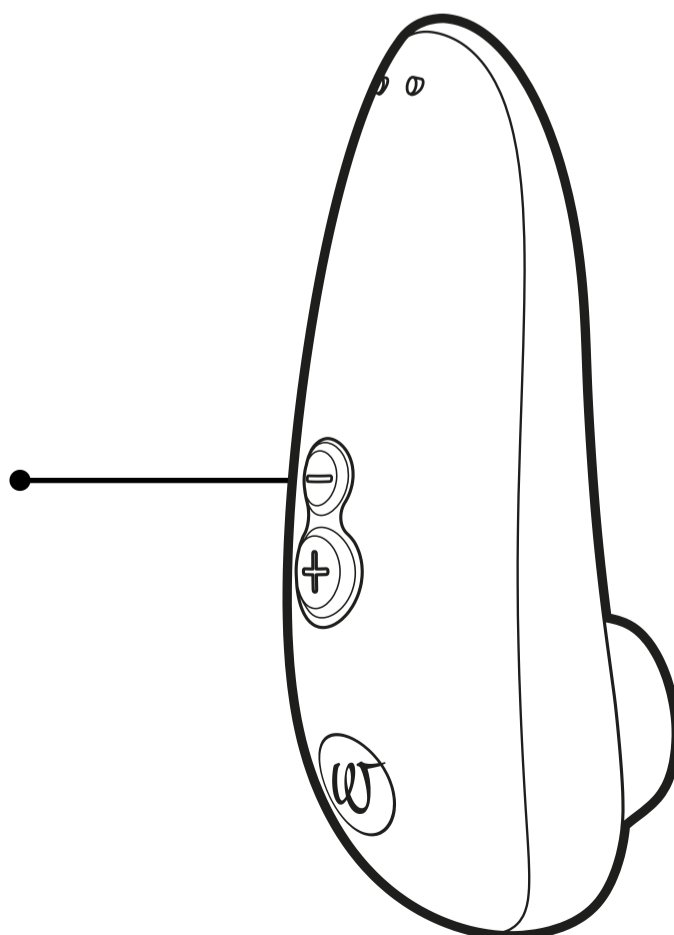

# CARREGAR

Carrega o teu Womanizer antes de o usares pela primeira vez. Lembra-te também de carregares regularmente o teu Womanizer, de modo a garantires uma longa duração da bateria.

## Carregamento via porta USB

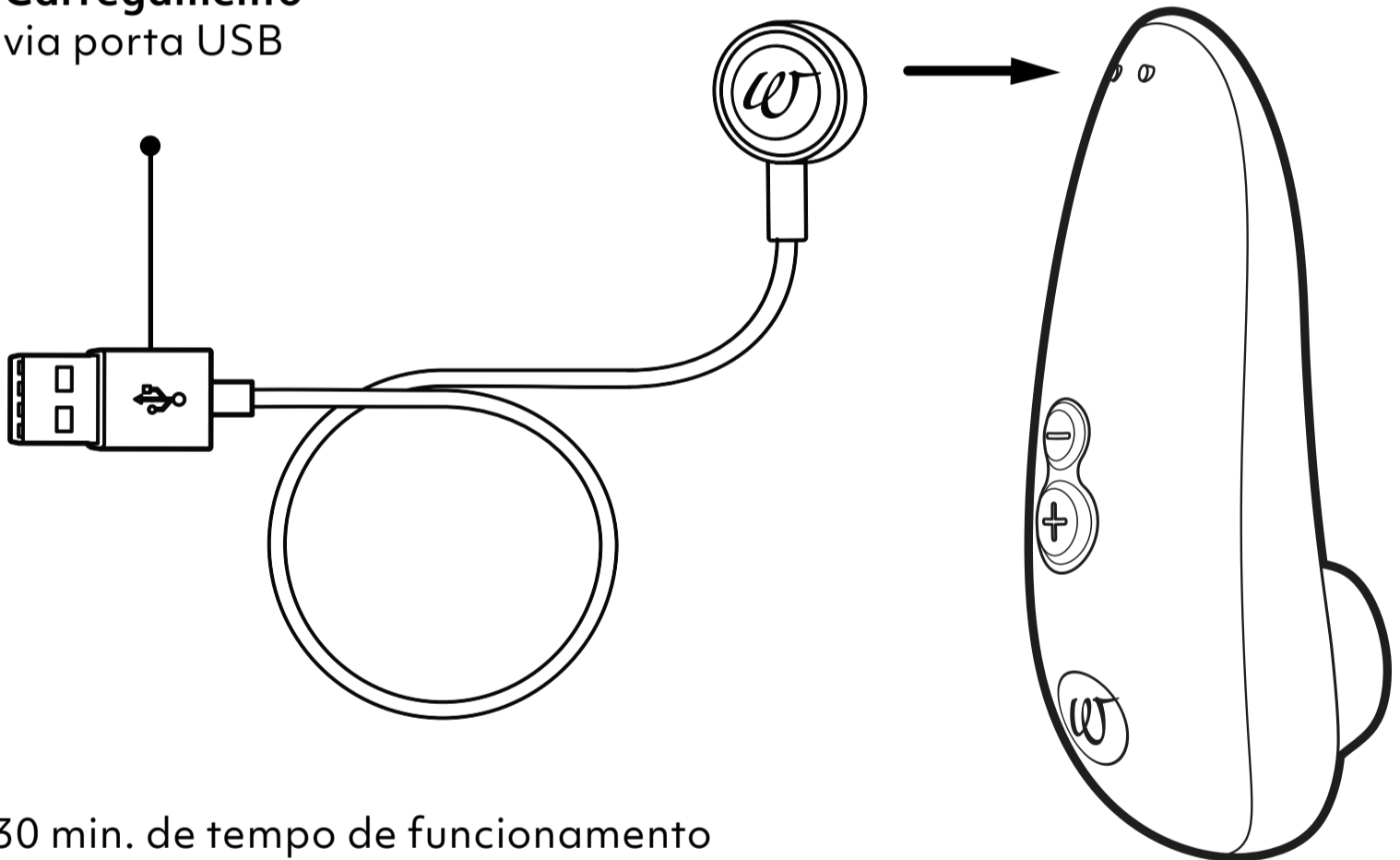

30 min. de tempo de funcionamento  
30 min. para uma carga total

# LIMPEZA

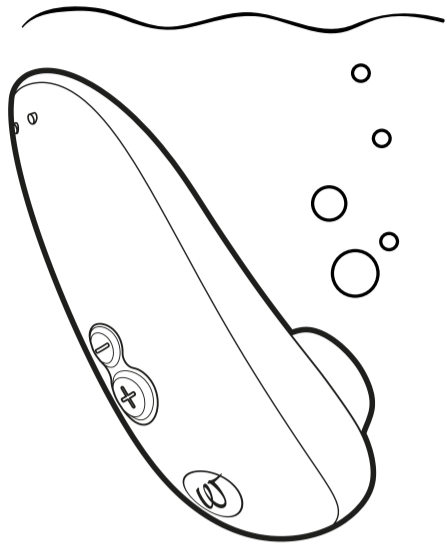

lavar debaixo de  
água

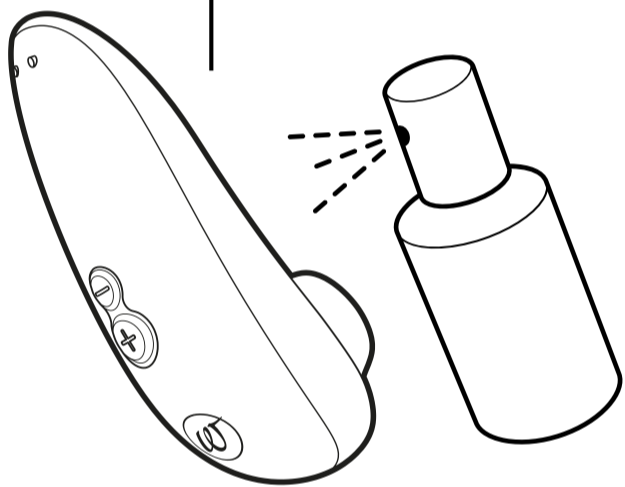

Aplicar detergente  
para brinquedos

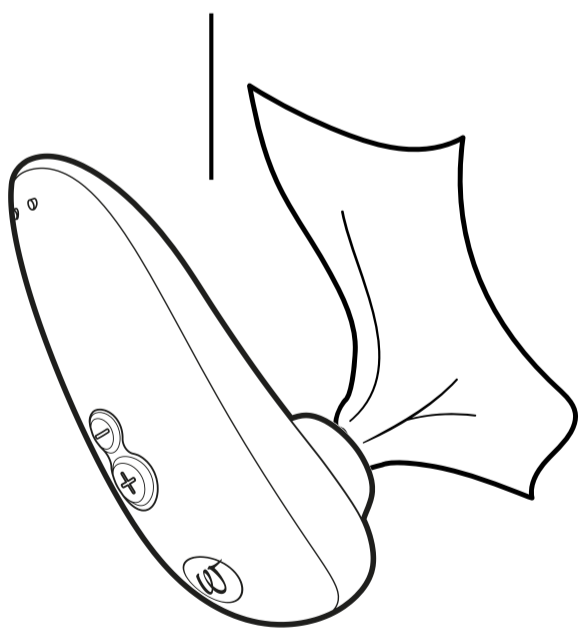

Secar

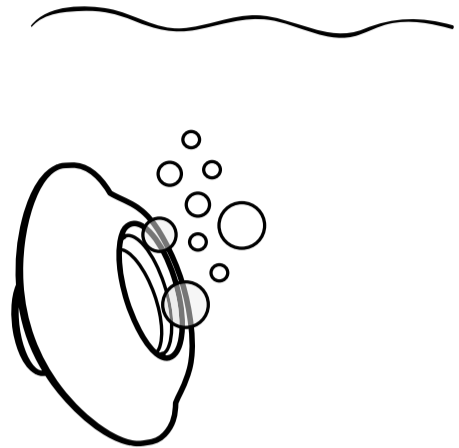

lavar debaixo de  
água

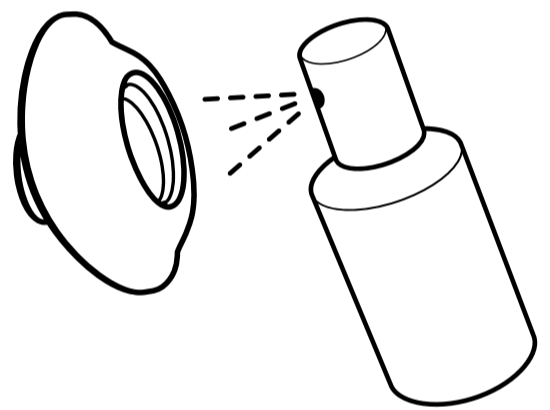

Aplicar detergente  
para brinquedos

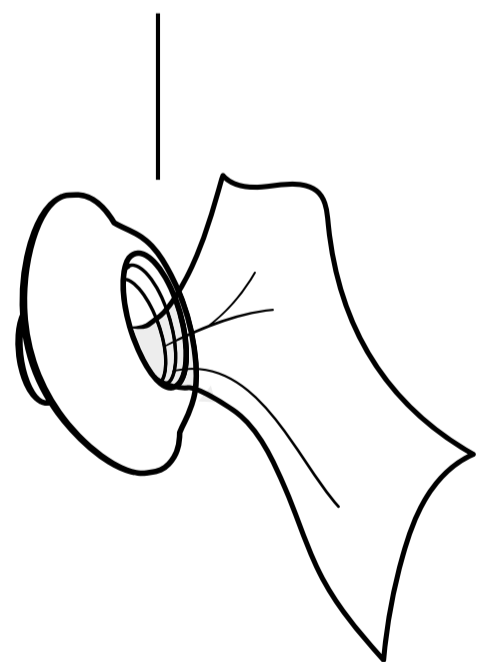

Secar



Waterproof  
IPX7

# INFORMAÇÃO GERAL

## AVISO

Para evitar danos, não utilizes géis lubrificantes com perfume, à base de álcool ou de silicone, ou óleos de massagem enquanto utilizas o teu Womanizer.

Limpa muito bem o teu Womanizer antes de o usares pela primeira vez e após cada utilização, a fim de reduzir o risco de infeções.

## ASSISTÊNCIA AO CLIENTE

Para mais informações, visita o nosso website [www.womanizer.com](http://www.womanizer.com) ou contacta o endereço [care@womanizer.com](mailto:care@womanizer.com).

## ESPECIFICAÇÕES TÉCNICAS

Modelo: WZ15B

Classificação elétrica: 3.7 V = 0.135 A:

Bateria recarregável de íões de lítio integrada.

5 V = 0.75 A : Quando carregada com USB.

Dispositivo de carga:

Adaptador USB CA (não incluído) com saída de potência correspondente à da classificação do produto. Não usar qualquer adaptador de carregamento rápido.

## CONTEÚDO

Womanizer Starlet 3, cabo de carga USB, guia de início rápido, instruções de segurança.

## ARMAZENAMENTO

Conservar num local seguro e seco, sem exposição direta à luz solar.

## GARANTIA E GARANTIA VOLUNTÁRIA DO FABRICANTE

A WOW TECH EUROPE GMBH disponibiliza aos seus clientes uma garantia voluntária do fabricante para este produto, para além da garantia obrigatória a que os consumidores têm direito perante os vendedores.

As condições relativas à garantia voluntária do fabricante encontram-se no nosso website, em "Condições de Garantia".

## CUMPRIMENTO DAS NORMAS

Este aparelho cumpre com todas as normas relativas à compatibilidade eletromagnética (CEM). O dispositivo pode ser utilizado em segurança desde que seja usado corretamente e de acordo com as instruções dadas neste manual do utilizador.

## PROTEÇÃO AMBIENTAL

Como distribuidores de dispositivos eletrónicos, somos legalmente obrigados a aceitar a devolução gratuita de dispositivos eletrónicos e elétricos usados. Declaramos expressamente que o utilizador tem a obrigação legal de devolver as baterias usadas. Nunca coloque os dispositivos eletrónicos ou baterias no lixo doméstico. O símbolo que se segue, que também se encontra nos nossos artigos eletrónicos, destina-se especificamente a lembrar este facto.

## DISTRIBUIDORA

WOW Tech Europe GmbH,  
Friedenstrasse 91 / 91 a, 10249 Berlin, Alemanha

A WOW Tech Europe GmbH reserva-se o direito de introduzir alterações técnicas e alterações ao design destinadas a melhorar o dispositivo.

Distribuído na América do Norte pela WOW TECH Canada Ltd. 1545 Carling Avenue, Suite 401, Ottawa ON, Canadá K1Z 8P9

[www.wowtech.com](http://www.wowtech.com) Concebido na Alemanha. Fabricado na China em 2021. Manual redigido em 02/2021. Versão 1.

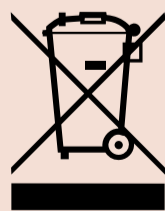

# AINDA QUERES MAIS?

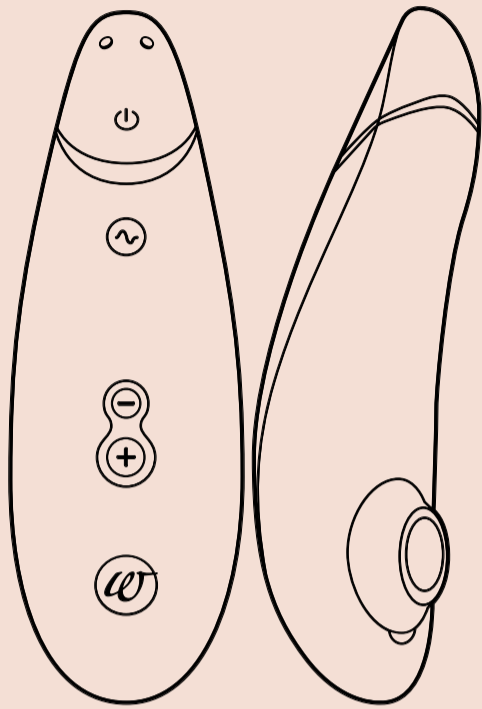

**Pleasure Air  
Technology**



**Smart Silence**

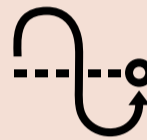

**Autopilot**

**Premium 2**  
Define your luxury

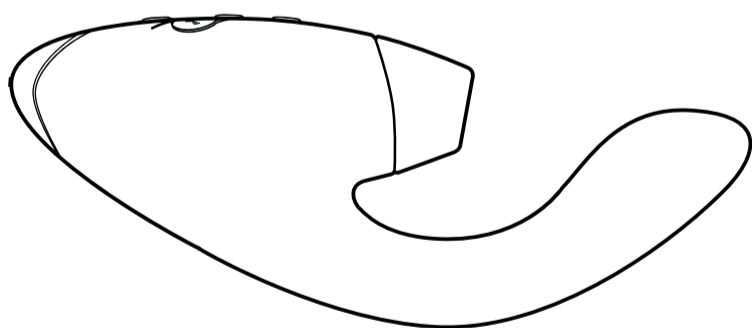

**Pleasure Air  
Technology**



**Vibrator**



**Smart Silence**

**DUO**  
Double your Pleasure



**#IMASTURBATE**



# Ciao!

**Grazie per aver scelto Womanizer!**

Benvenuta in un mondo di esperienze sensuali che arricchiranno la tua vita. Scegliendo WOMANIZER, non solo avrai la certezza di raggiungere orgasmi pazzeschi, ma riscoprirai anche il desiderio di provare piacere.

**Goditi il tuo WOMANIZER. Un orgasmo dopo l'altro.**

Vai, amati!



**DESCRIZIONE DEL PRODOTTO**

**ISTRUZIONI PER L'USO**

**RICARICA**

**PULIZIA**

**INFORMAZIONI GENERALI**

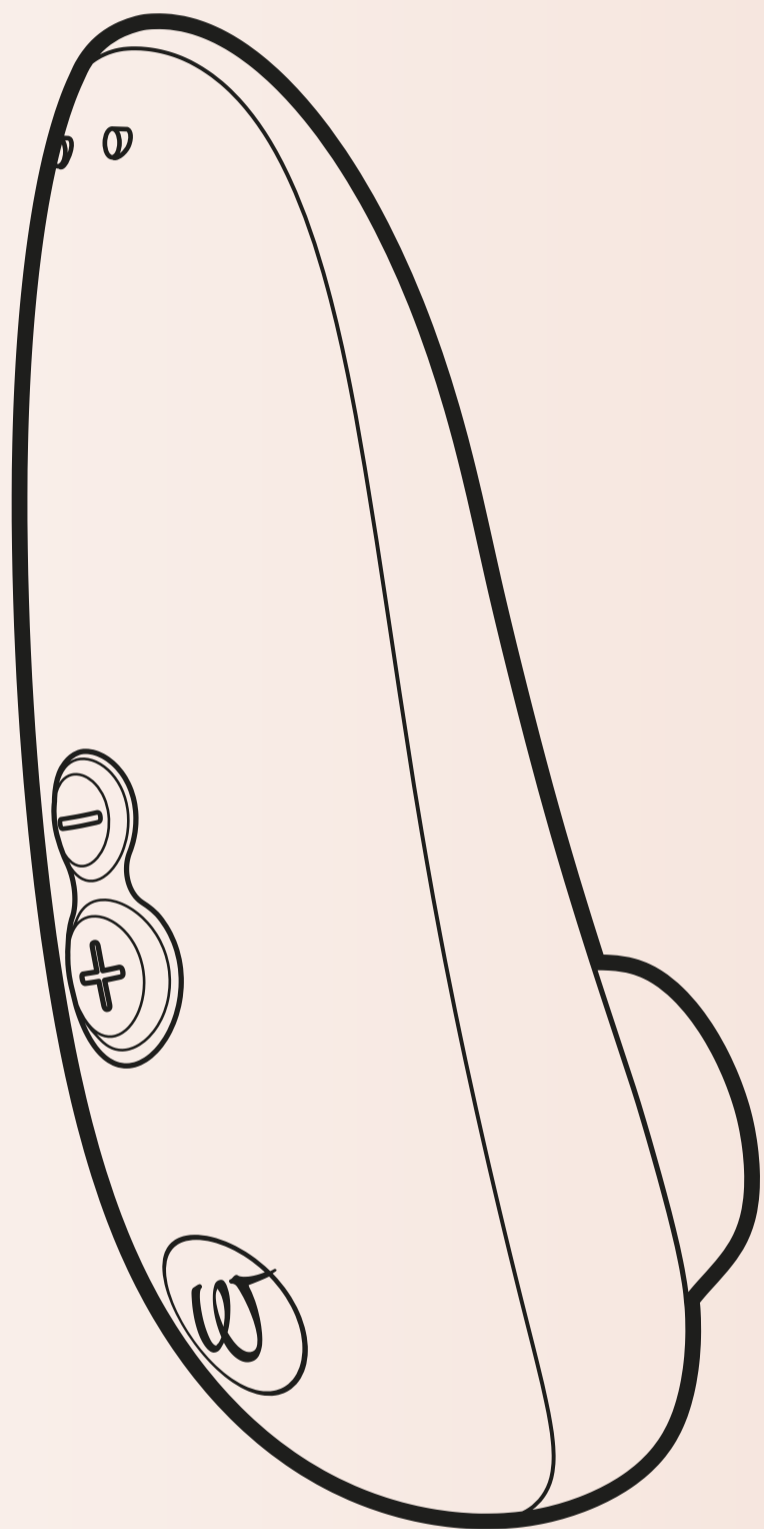

# DESCRIZIONE DEL PRODOTTO

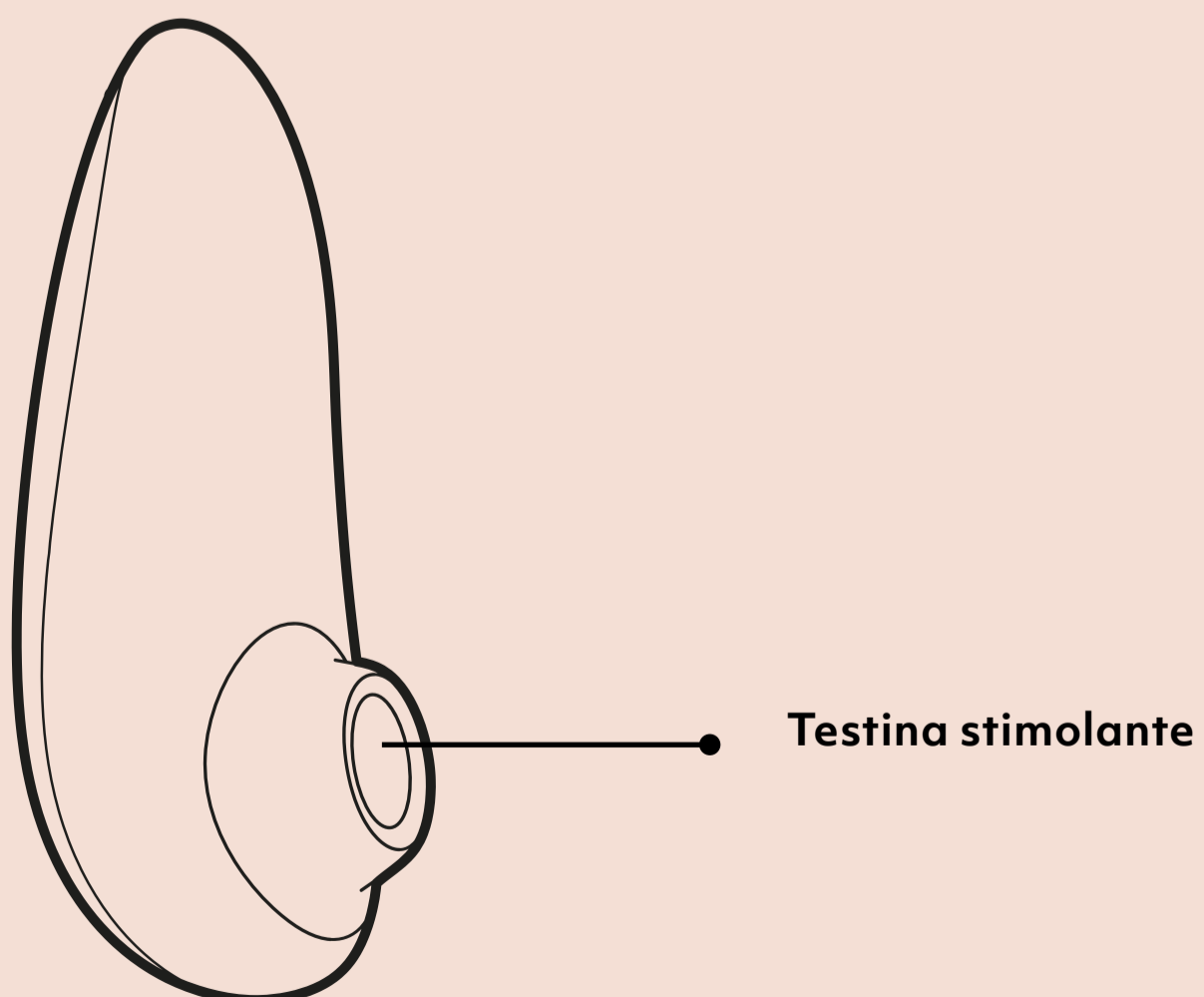
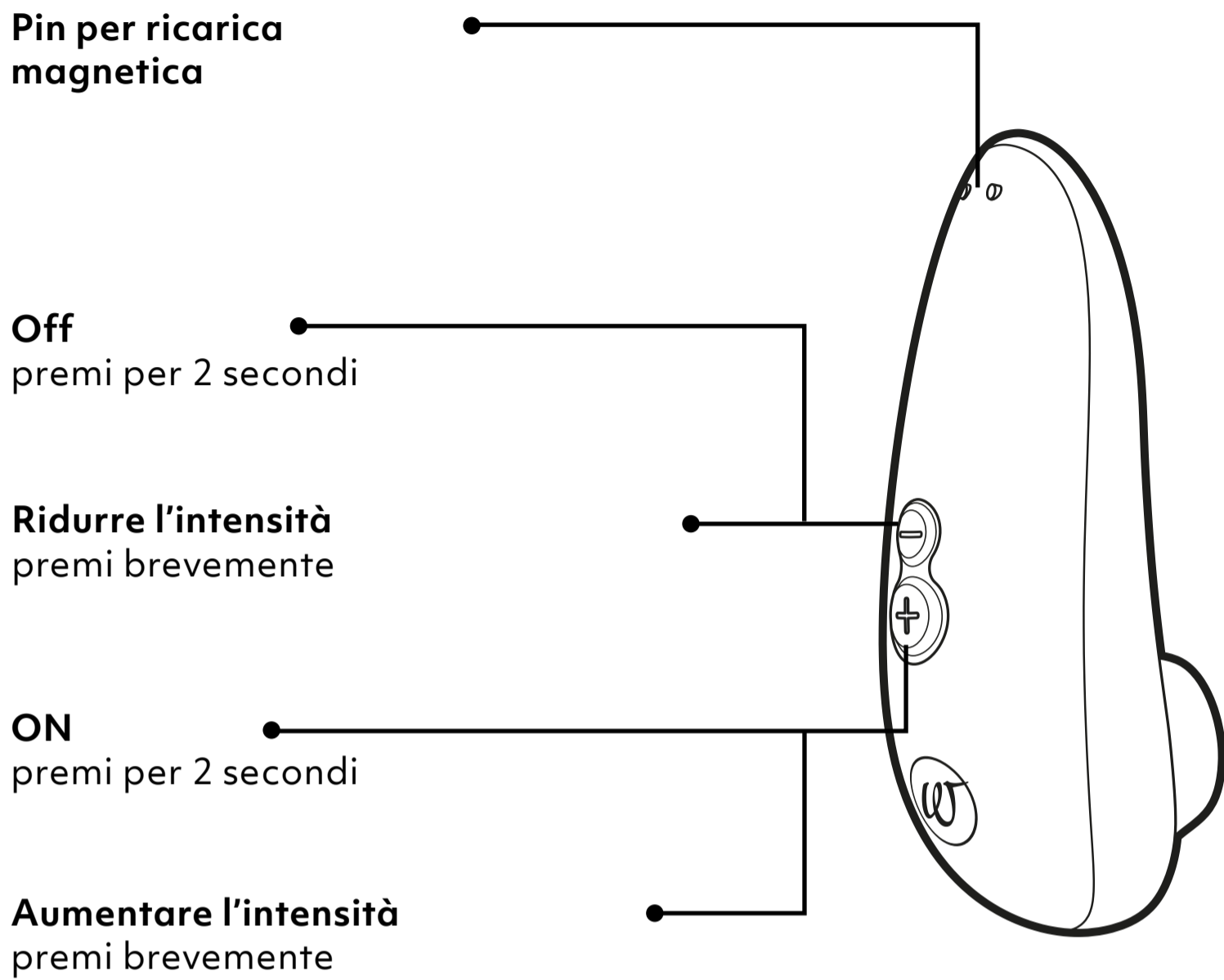

# ISTRUZIONI PER L'USO

## 1. Accensione

Premi per  
2 secondi

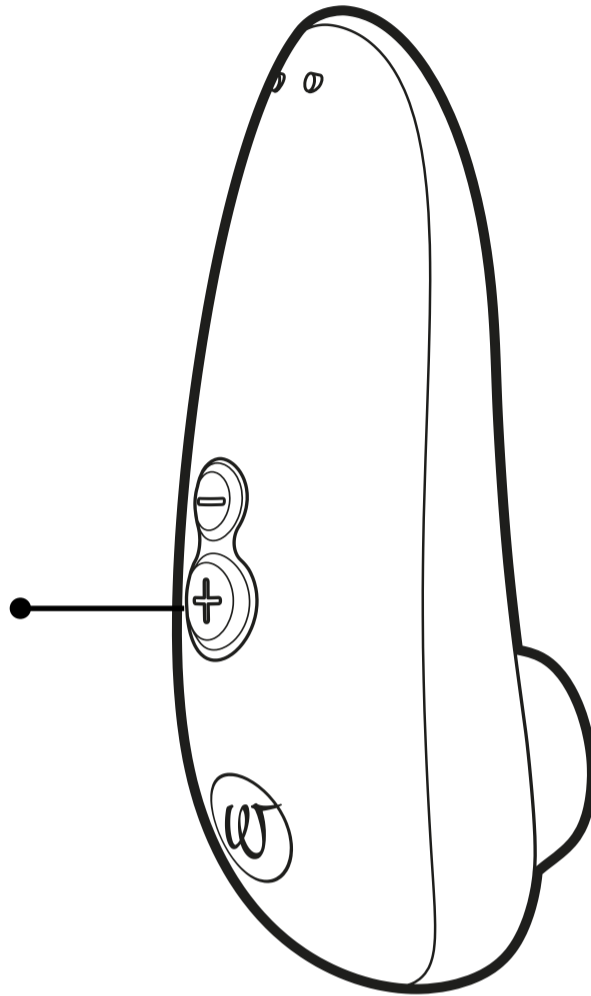

## 2. Uso

Avvolgi il clitoride con la testina di stimolazione per iniziare il tuo viaggio.

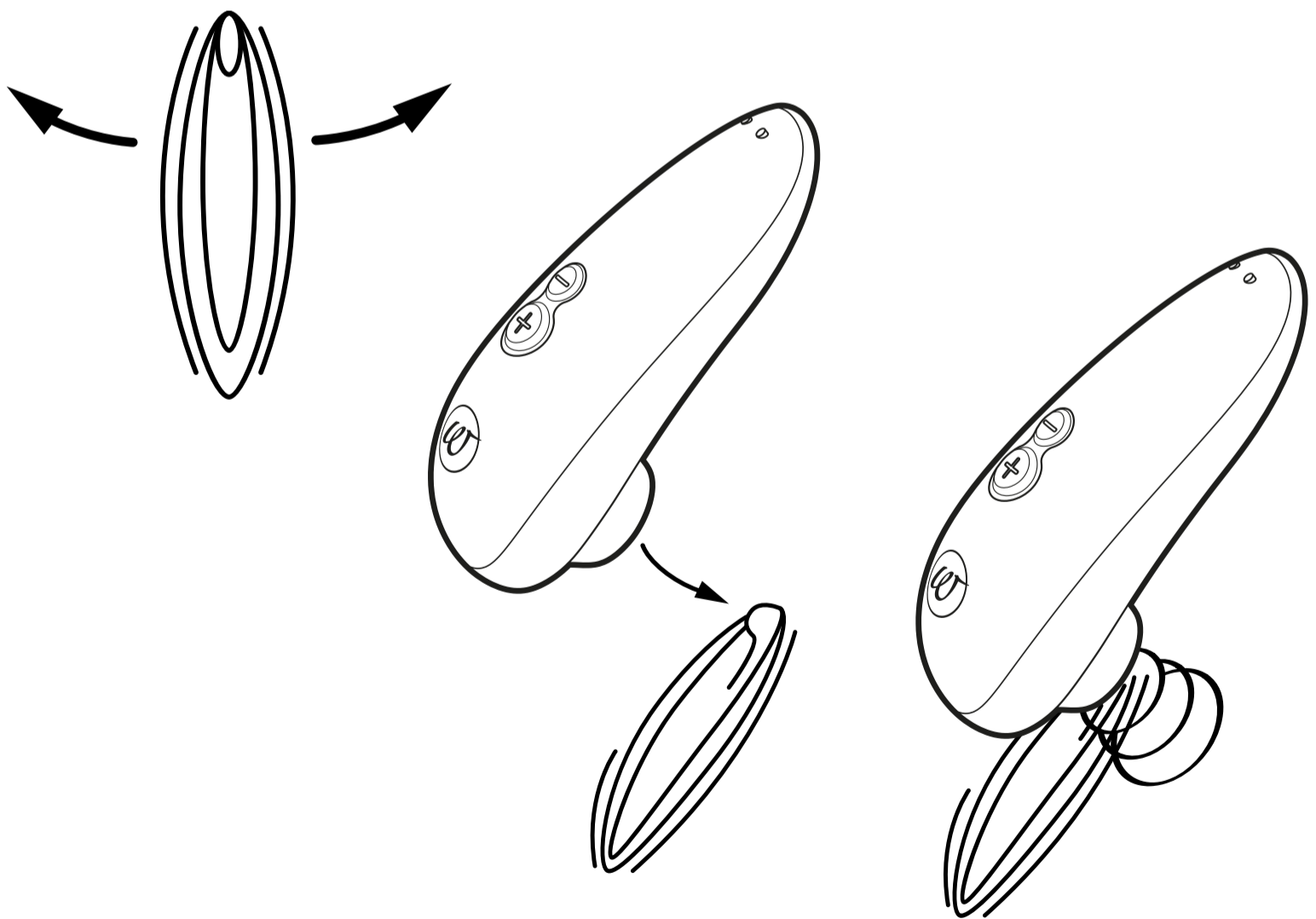

### 3. Cambio di intensità

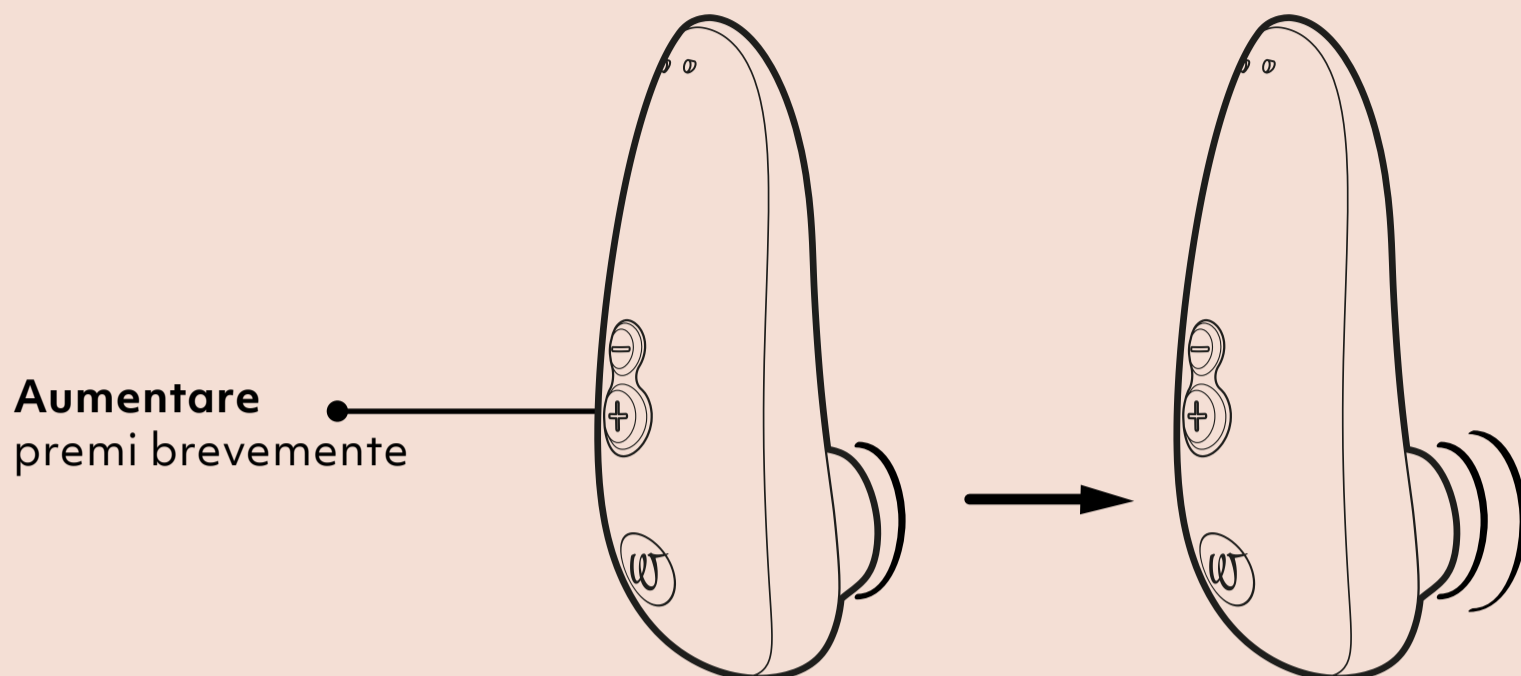

**6**  **Livelli di intensità**

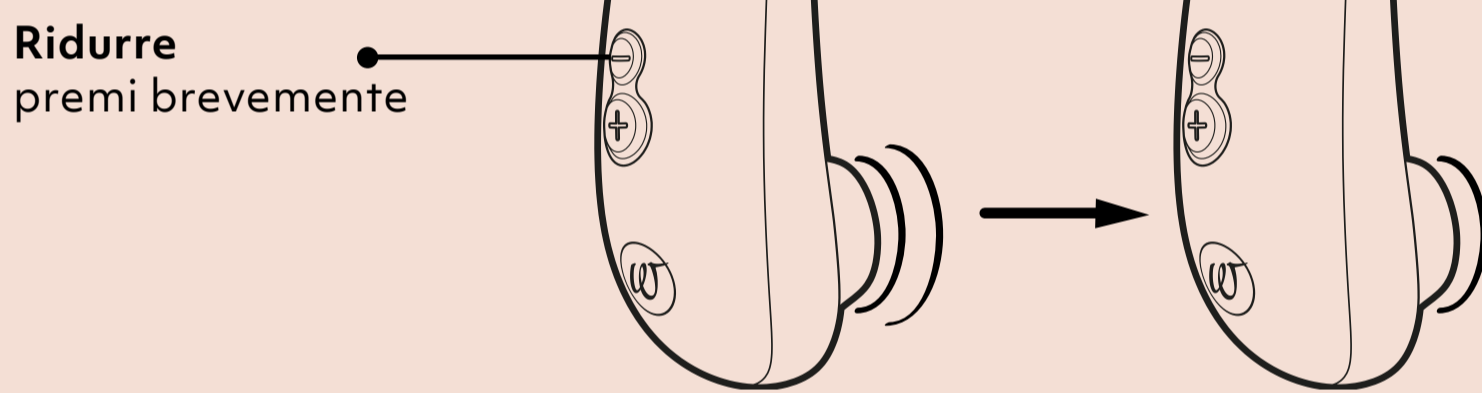

### 4. Spegner

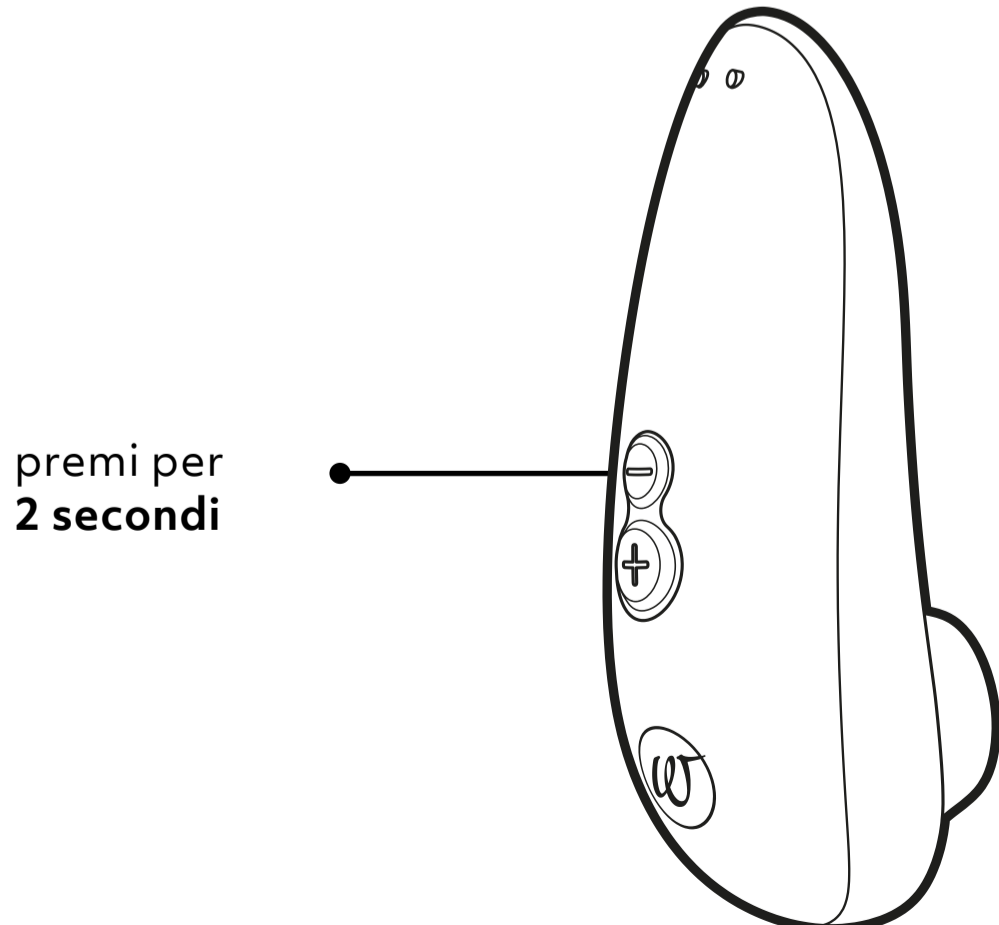

# RICARICA

Prima di inaugurarlo, ti invitiamo a caricare il tuo Womanizer.  
E ricorda di ricaricarlo regolarmente, per garantire una lunga durata della batteria.

**Ricarica**  
tramite porta USB

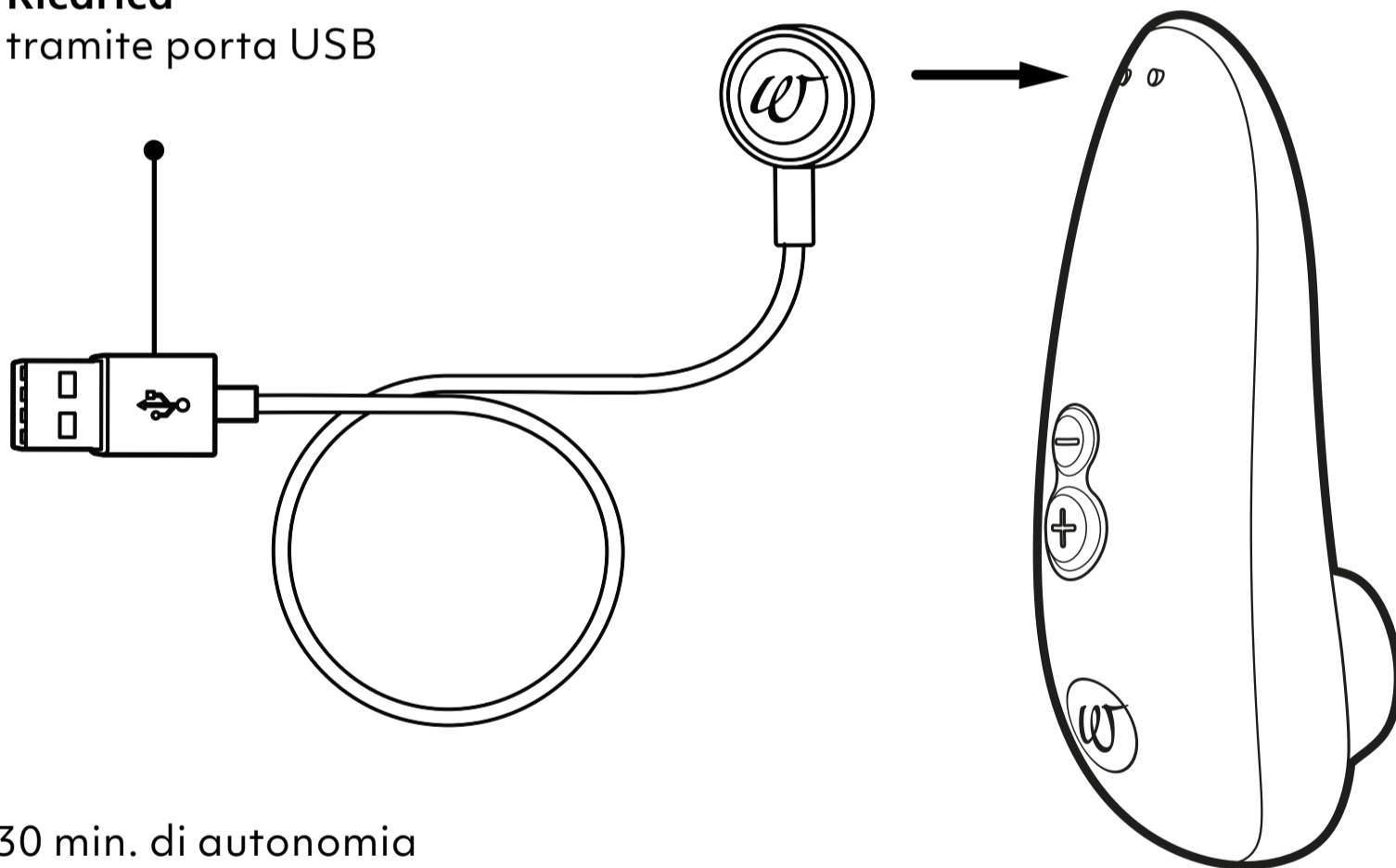

30 min. di autonomia  
30 min. per una carica completa

# PULIZIA

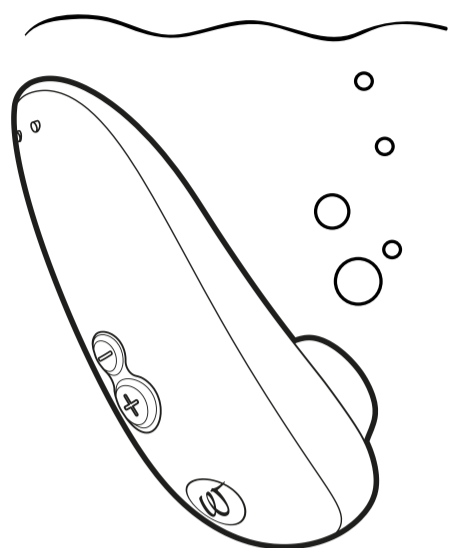

lavalo sotto  
l'acqua corrente

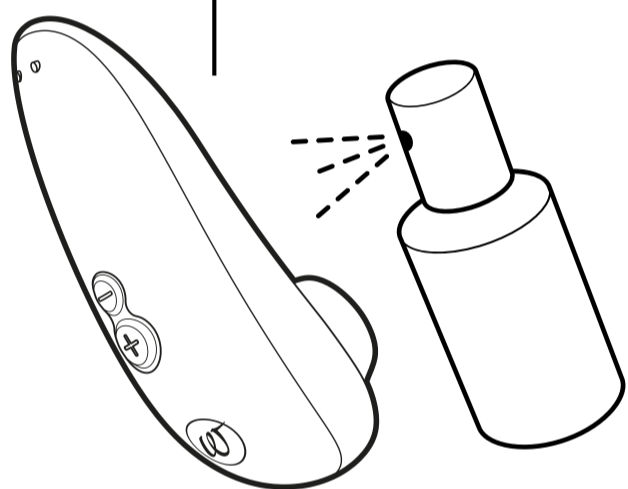

Applicare detergente  
speciale

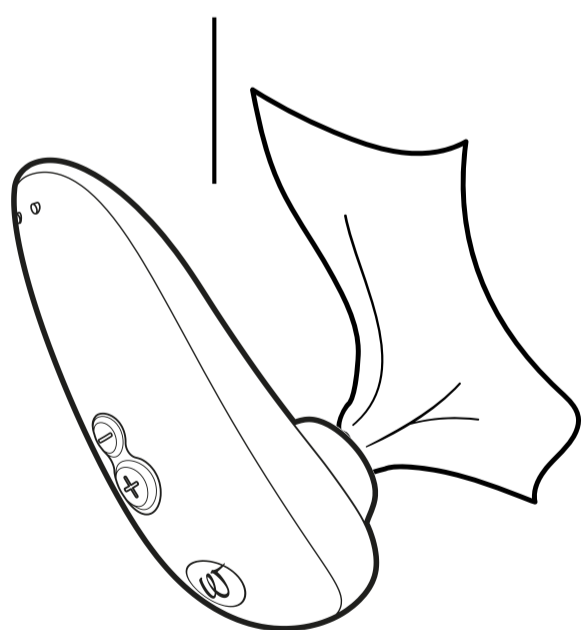

Asciugare

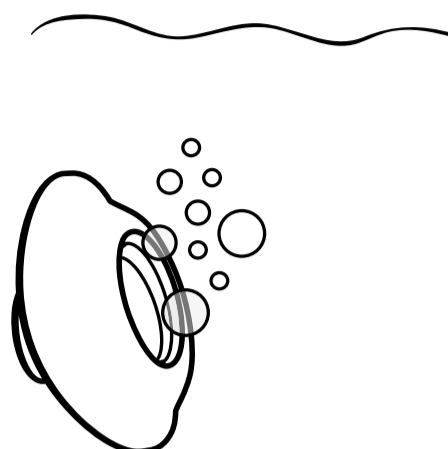

lavalo sotto  
l'acqua corrente

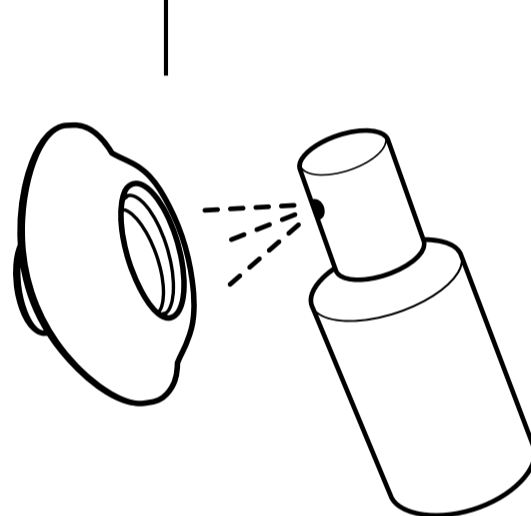

Applicare detergente  
speciale

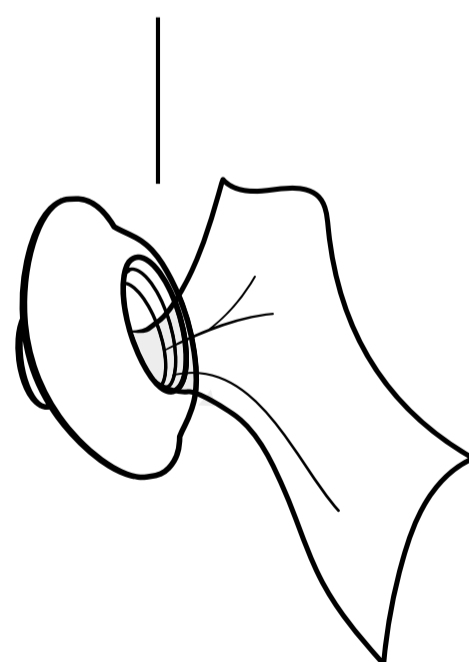

Asciugare

+



Waterproof  
IPX7



# INFORMAZIONI GENERALI

## ATTENZIONE

Per evitare danni, quando usi il tuo Womanizer non utilizzare lubrificanti, gel o oli da massaggio profumati a base alcolica o siliconici.

Pulisci accuratamente il tuo Womanizer prima di inaugurarlo e dopo ogni uso, per ridurre il rischio di infezioni.

## CUSTOMER CARE

Per maggiori informazioni visita il nostro sito [www.womanizer.com](http://www.womanizer.com) o contattaci all'indirizzo [care@womanizer.com](mailto:care@womanizer.com).

## SPECIFICHE TECNICHE

Modello: WZ15B

Tensione elettrica: 3,7  $\pm$  0,135 A:  
batteria ricaricabile agli ioni di litio integrata.

5 V  $\pm$  0,75 A: quando la ricarica avviene tramite USB.

Dispositivo di ricarica:  
adattatore USB/AC (non incluso)  
con potenza in uscita corrispondente alla categoria di prodotto. Non usare adattatori a carica rapida.

## CORREDO DI FORNITURA

Womanizer Starlet 3, cavo di ricarica USB, guida d'uso rapida, istruzioni di sicurezza.

## CONSERVAZIONE

Conservare in un luogo sicuro e asciutto al riparo dalla luce diretta del sole.

## GARANZIA E GARANZIA VOLONTARIA DEL PRODUTTORE

Per questo prodotto, WOW TECH EUROPE GMBH offre una garanzia volontaria del produttore, in aggiunta alla garanzia di legge a cui l'acquirente ha diritto nei confronti del venditore.

I termini e le condizioni della garanzia volontaria del produttore sono consultabili sul nostro sito web alla voce "Warranty Conditions".

## CONFORMITÀ A NORME

Questo dispositivo è conforme alle norme riguardanti la compatibilità elettromagnetica (EMC). L'utilizzo del dispositivo è sicuro a condizione che venga usato correttamente e nel ri-

spetto delle istruzioni fornite in questo manuale.

## PROTEZIONE AMBIENTALE

Essendo distributori di dispositivi elettronici, siamo legalmente tenuti ad accettare gratuitamente la restituzione di apparecchiature elettriche ed elettroniche da smaltire. Ti informiamo esplicitamente che, in veste di utilizzatore, sei obbligato per legge a restituire le batterie usate. I dispositivi elettronici o le batterie non devono mai essere smaltiti con i normali rifiuti domestici.

Per ricordartelo, anche sui nostri dispositivi elettronici è riportato il simbolo che vedi qui sotto.

## DISTRIBUTORE

WOW Tech Europe GmbH,  
Friedenstrasse 91 / 91 a, 10249 Berlin, Germany

WOW Tech Europe GmbH reserves the right to make technical changes and changes to the design that serve to improve the device.

Distribuito in Nord America da WOW TECH Canada Ltd. 1545 Carling Avenue, Suite 401, Ottawa ON, Canada K1Z 8P9

[www.wowtech.com](http://www.wowtech.com) Progettato in Germania. Made in China nel 2021. Manuale pubblicato a 02/2021. Versione 1.

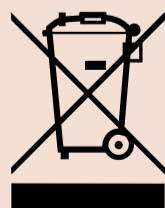

# NE VUOI ANCORA?

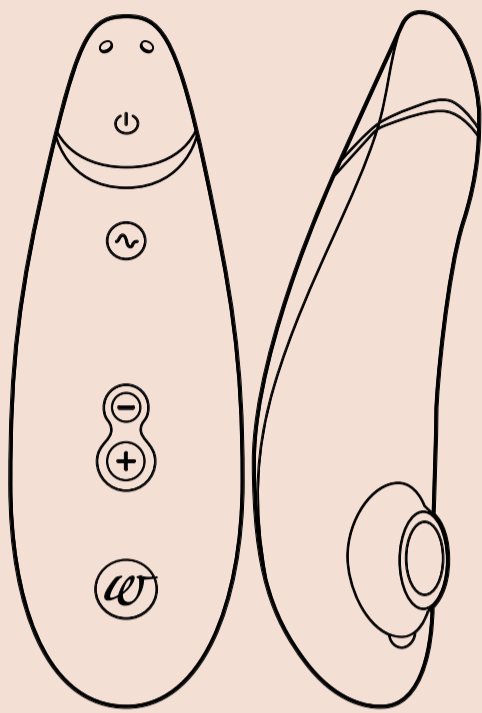

**Pleasure Air  
Technology**



**Smart Silence**

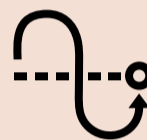

**Autopilot**

## **Premium 2**

Define your luxury

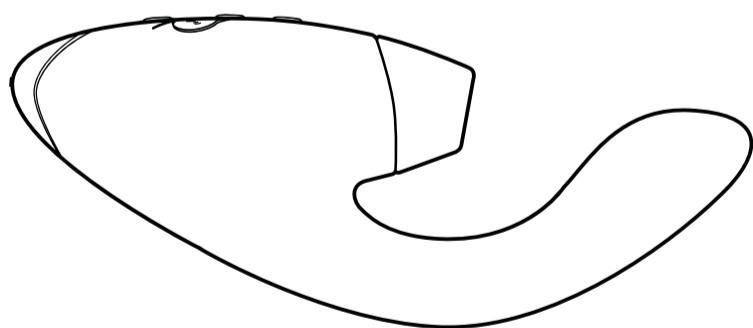

**Pleasure Air  
Technology**



**Vibrator**



**Smart Silence**

## **DUO**

Double your Pleasure



**#IMASTURBATE**

# Hej!

**Tak fordi du valgte Womanizer**

Velkommen til en verden fuld af sanselige oplevelser, der vil berige dit liv. Ved at vælge WOMANIZER er du ikke kun garanteret orgasmer, der er uden sammenligning - men også en helt ny lyst til nydelse.

**Nyd din WOMANIZER - den ene orgasme efter den anden.**

Af sted, elsk dig selv!



**PRODUKTBEKRIVELSE**

**SÅDAN BRUGES PRODUKTET**

**OPLADNING**

**RENGØRING**

**GENEREL INFORMATION**

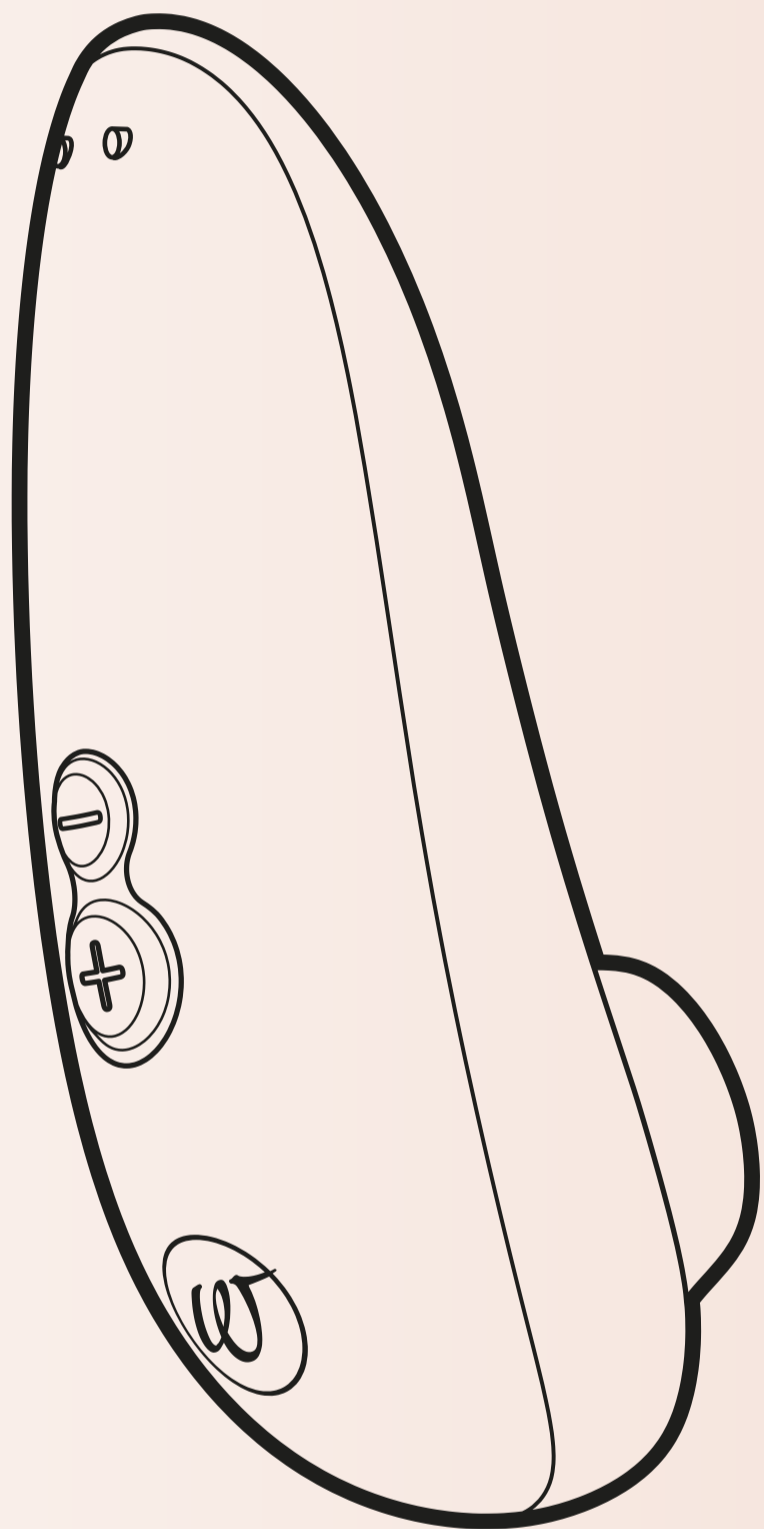

# PRODUKTBESKRIVELSE

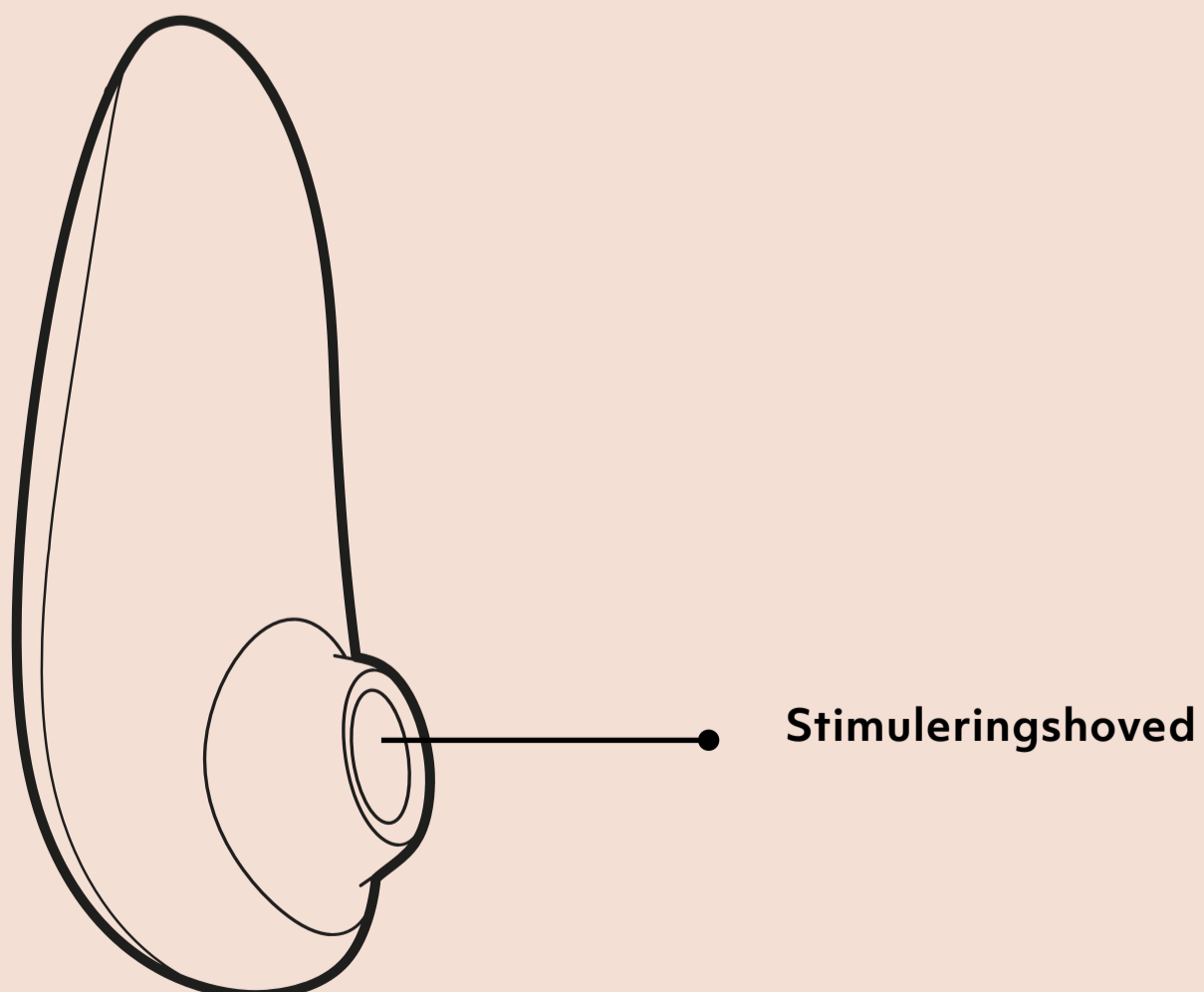
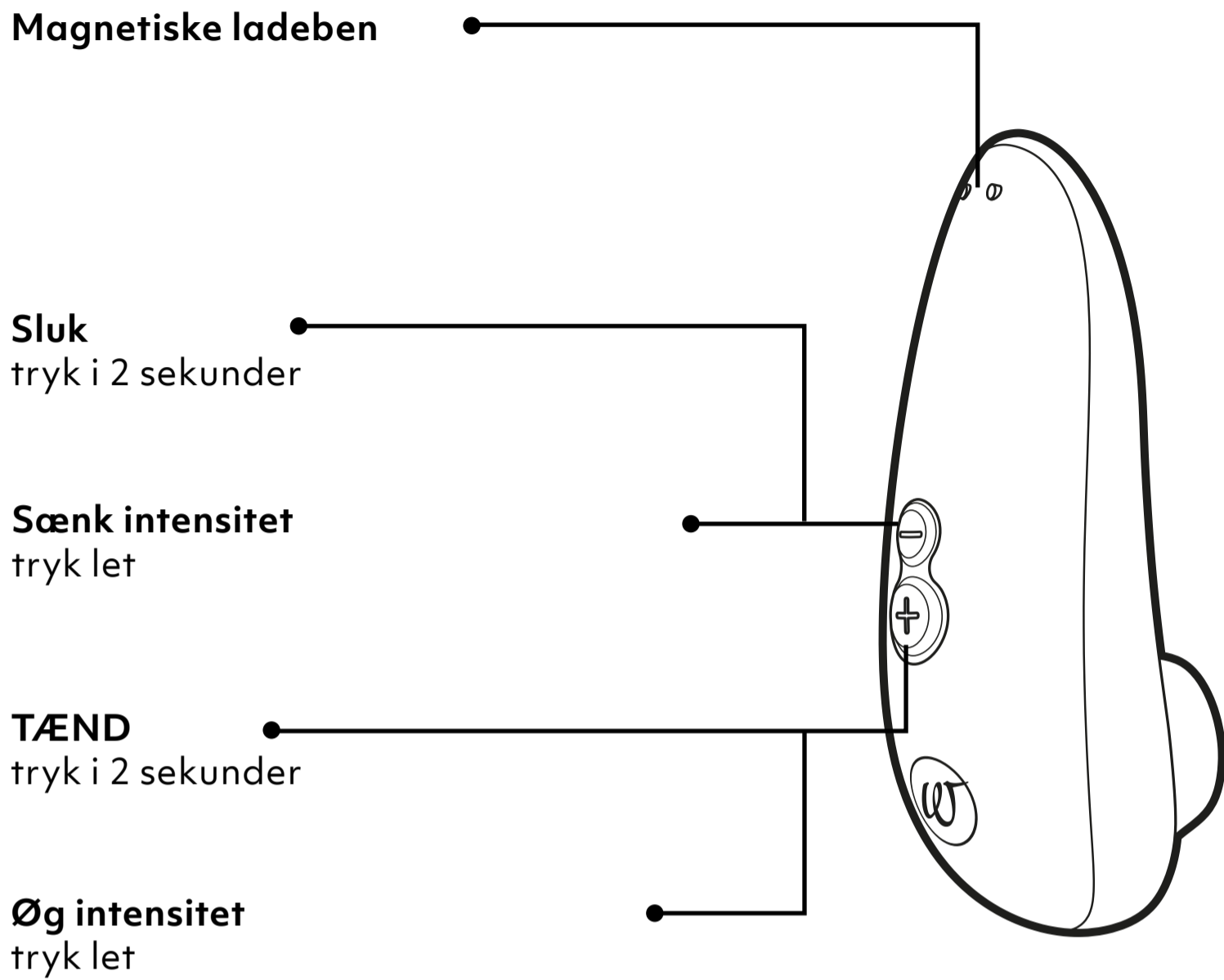

# SÅDAN BRUGES PRODUKTET

## 1. Tænd

Tryk i  
2 sekunder

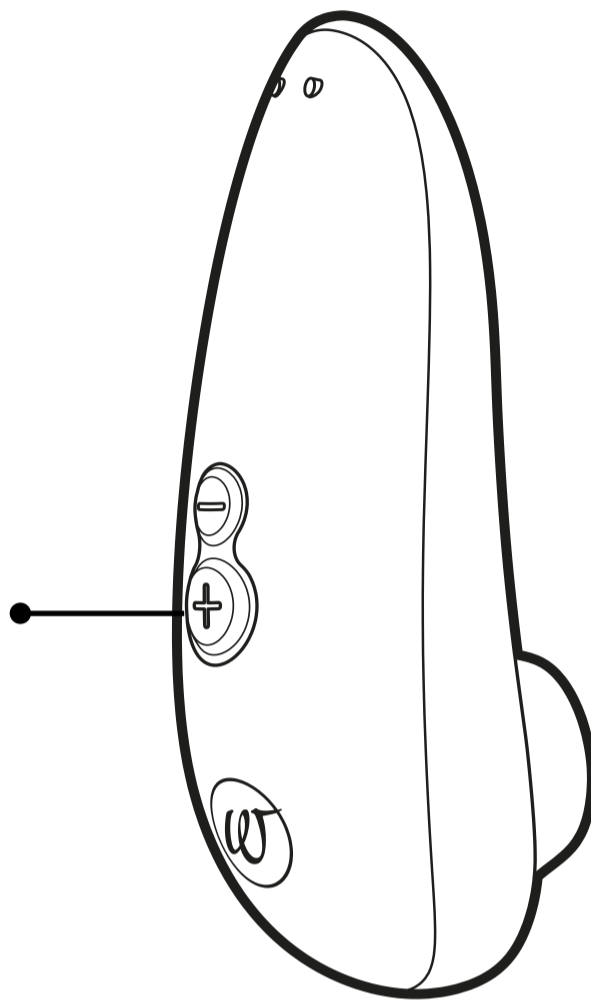

## 2. Anvendelse

Omgiv din klitoris med stimuleringshovedet, og så begynder din rejse.

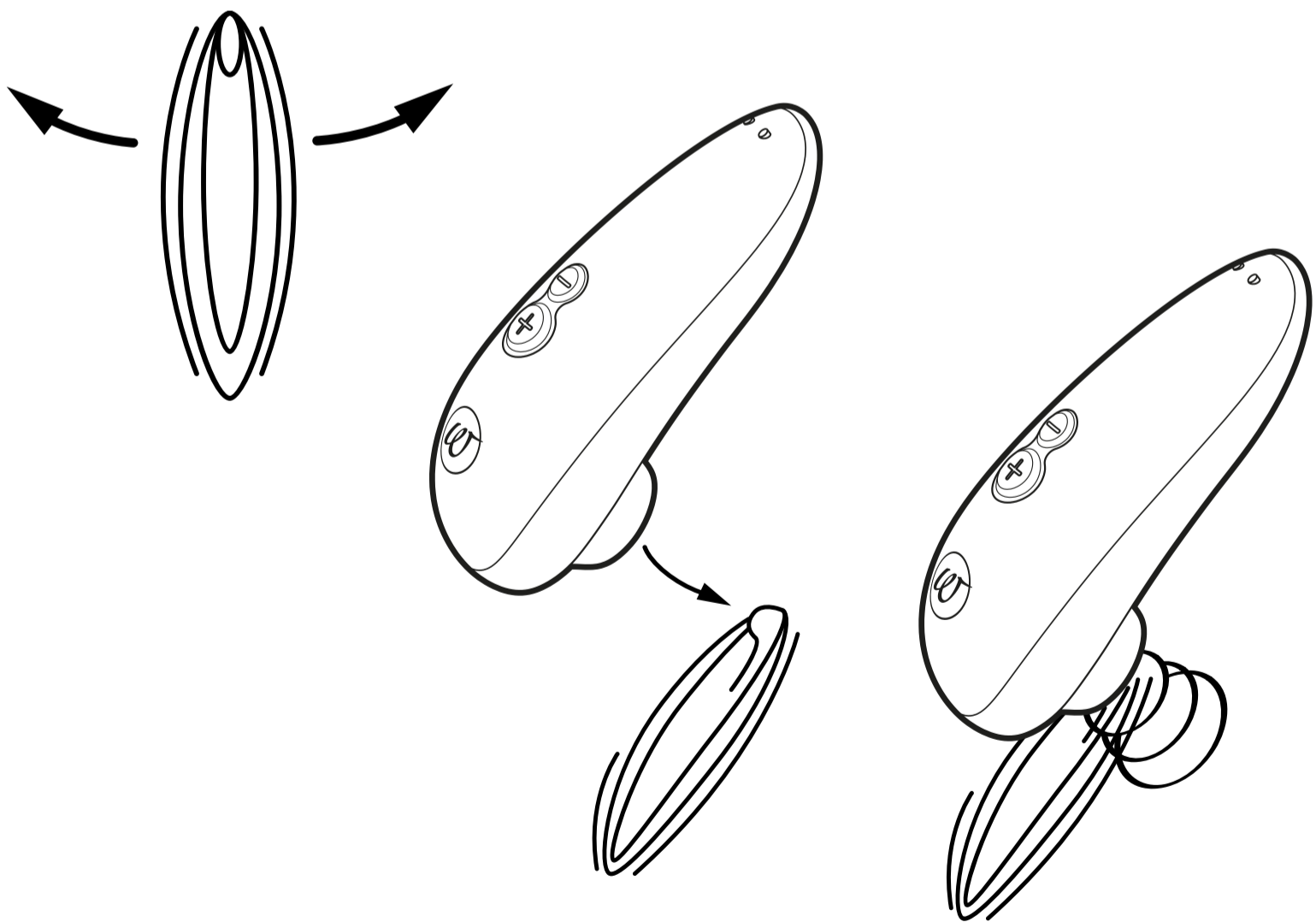



### 3. Skift styrke

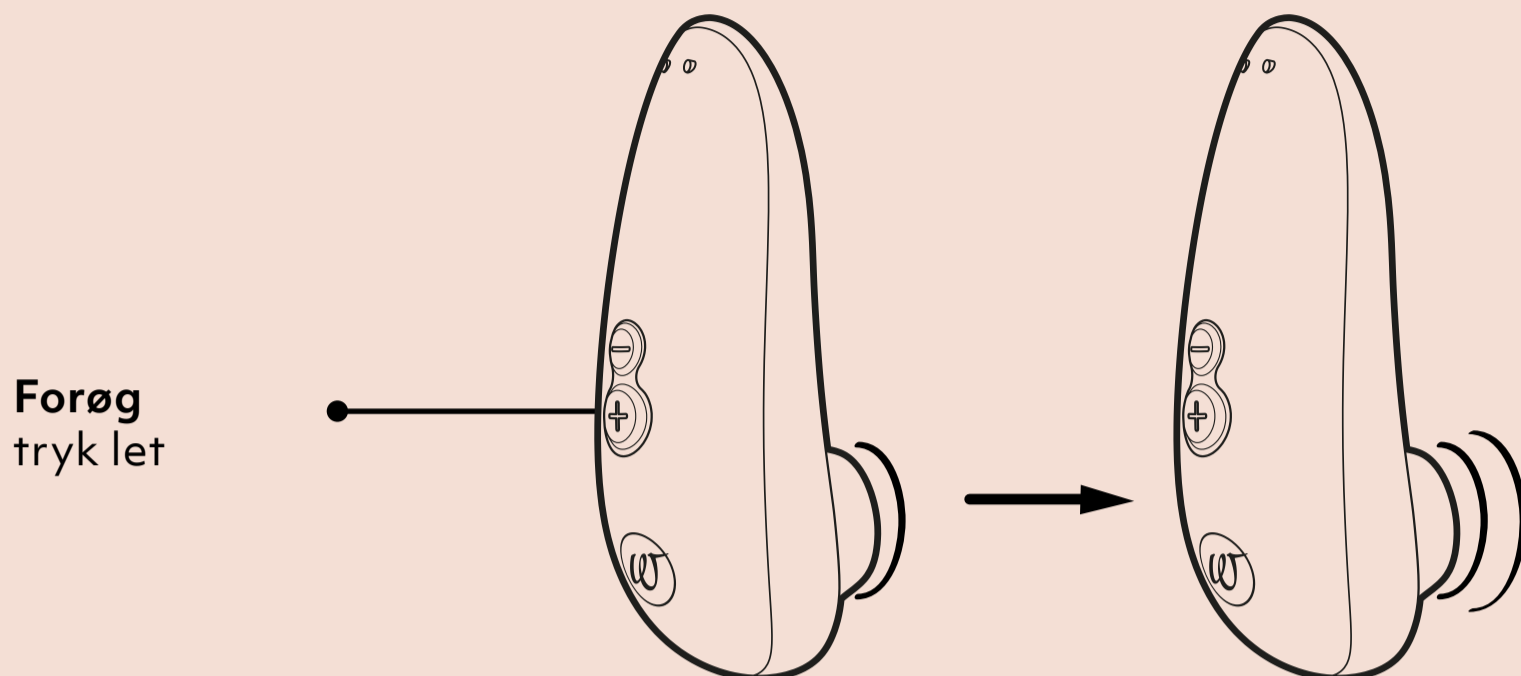

### 6 ⇄ Styrkeniveauer

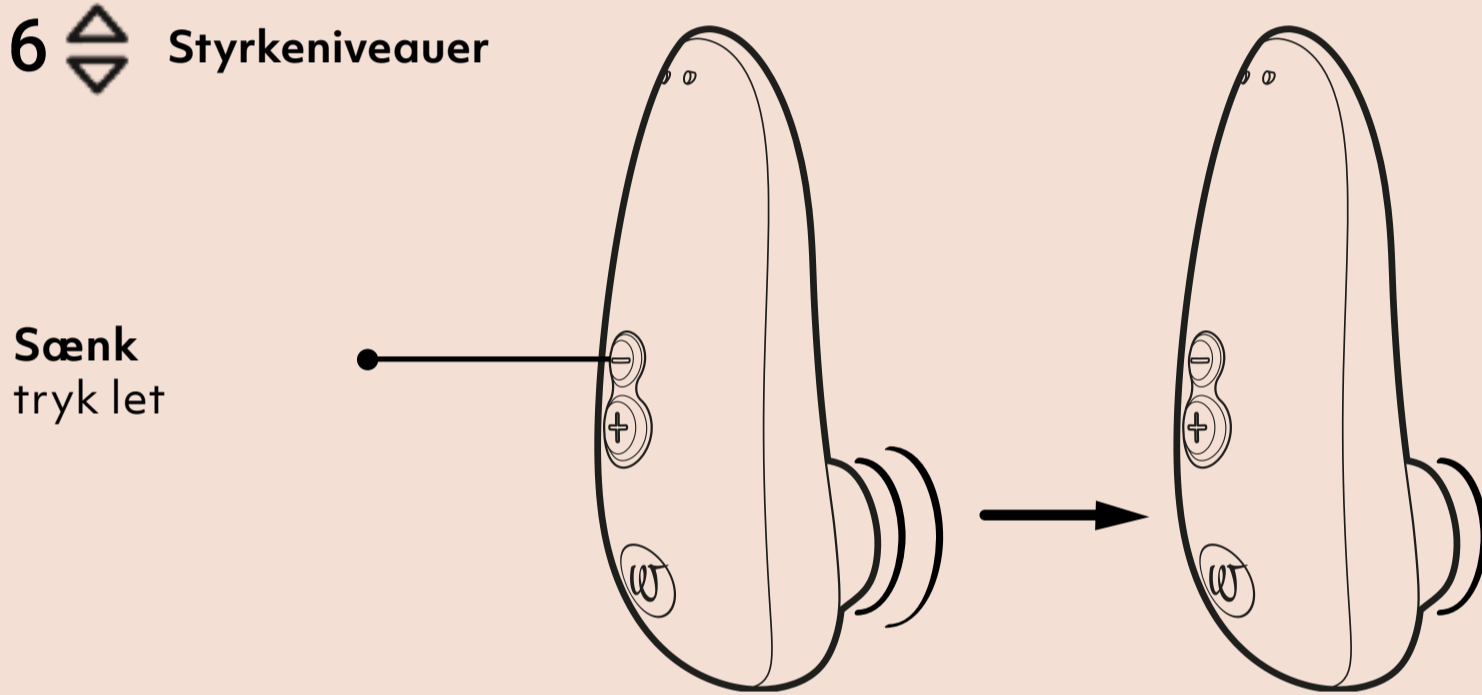

### 4. Sluk

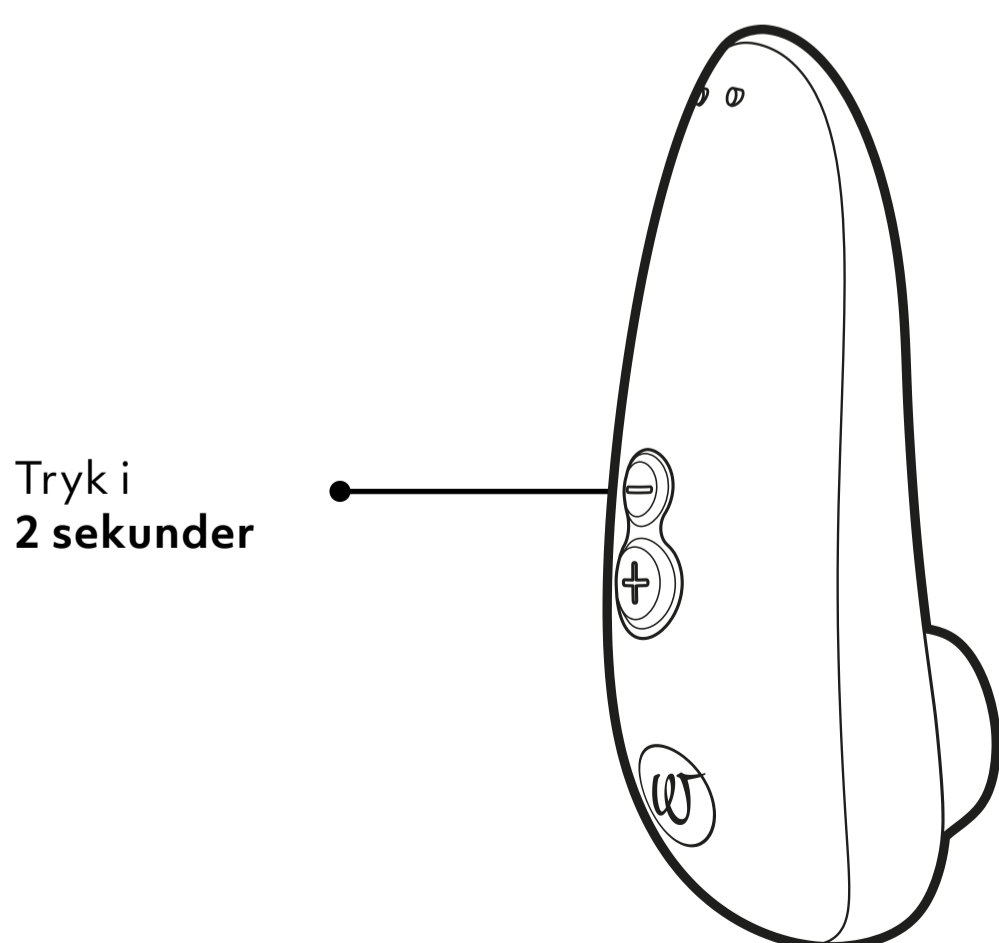

# OPLADNING

Venligst oplad din Womanizer før første brug. Husk også at genoplade din Womanizer regelmæssigt for at sikre en lang batterilevetid.

**Opladning**  
via USB port

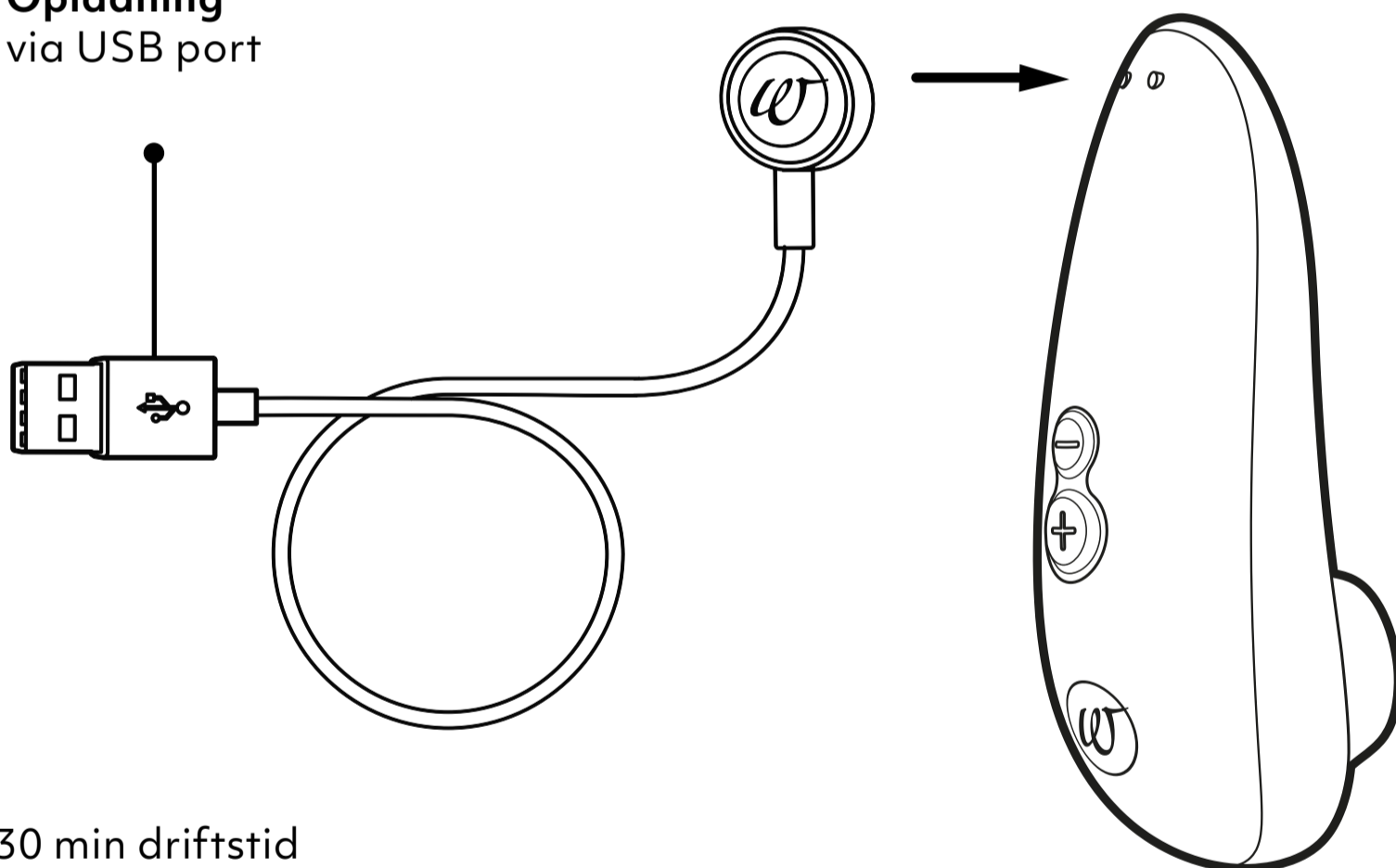

30 min driftstid  
30 min til fuld opladning

# RENGØRING

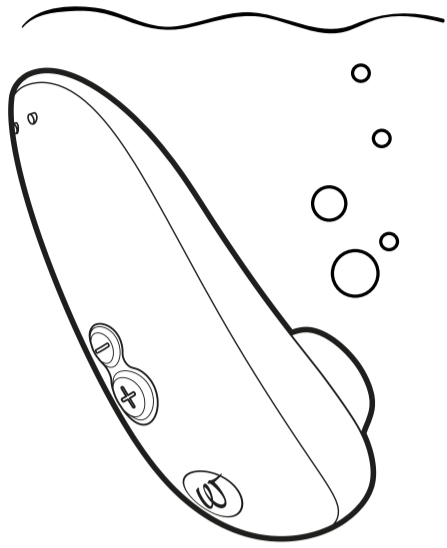

vask under vandet

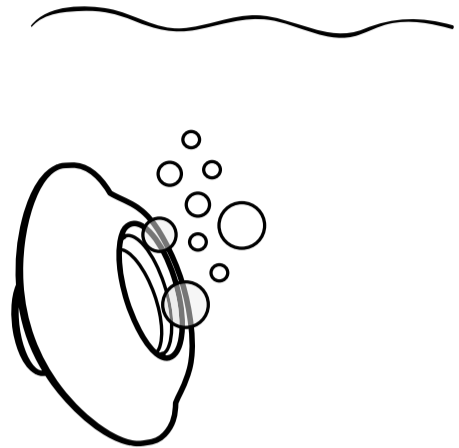

vask under vandet

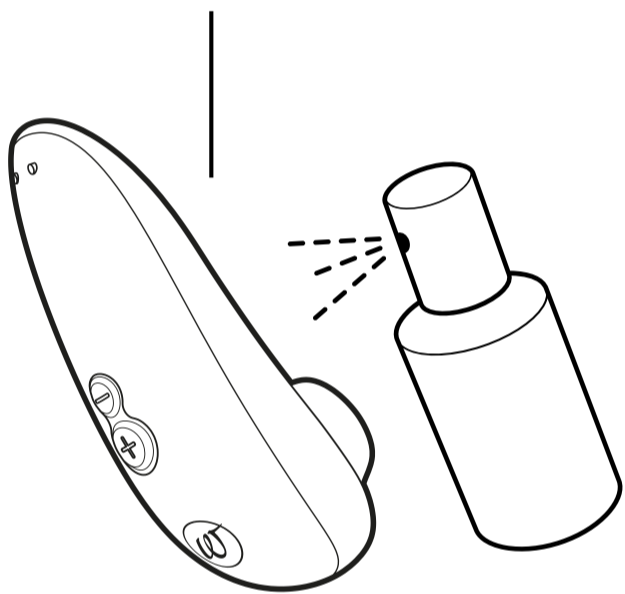

Brug legetøjsrens

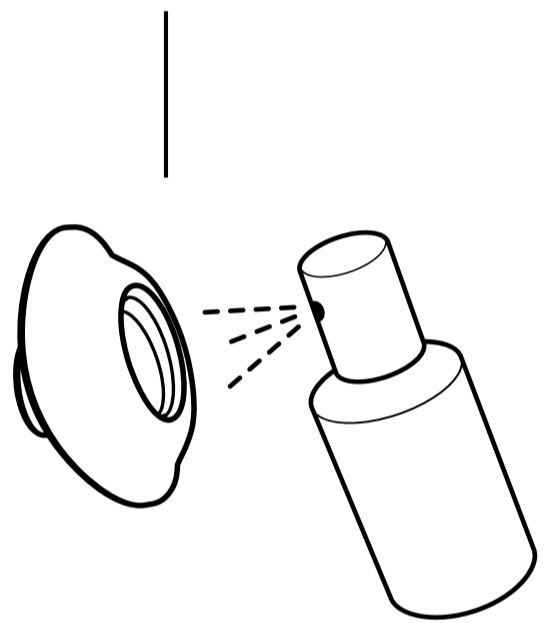

Brug legetøjsrens

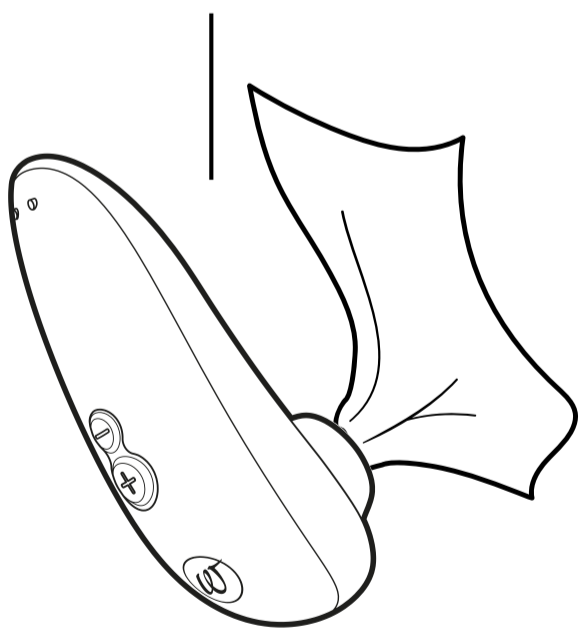

Tør

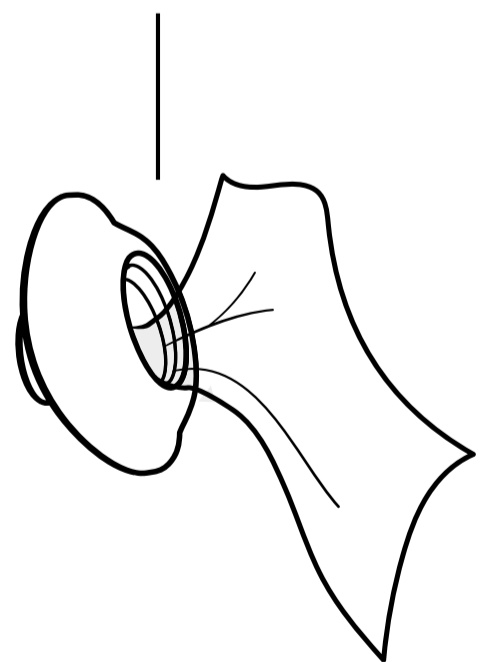

Tør



Waterproof  
IPX7

# GENEREL INFORMATION

## ADVARSEL

Anvend ikke parfumerede, alkohol- eller silikonebaserede geléer eller massageolier under brugen af Womanizer. Rengør din Womanizer grundigt inden første brug og efter hver brug for at reducere risikoen for infektion.

## KUNDESERVICE

Få yderligere information ved at gå ind på vores hjemmeside [www.womanizer.com](http://www.womanizer.com), eller kontakt [care@womanizer.com](mailto:care@womanizer.com).

## TEKNISKE SPECIFIKATIONER

Model: WZ15B

Elektrisk vurdering: 3.7V=0.135 A:

Indbygget lithium-ion genopladeligt batteri.

5 V=0.75 A : Ved opladning med USB.

Opladningsenhed:

USB/AC-adapter (ikke inkluderet) med effekt, der svarer til produktvurderingen. Brug ikke hurtig-opladeradapter.

## LEVERINGSOMFANG

Womanizer Starlet 3, USB ladekabel, hurtig startguide, sikkerhedsanvisninger.

## OPBEVARING

Opbevar enheden på et sikkert, tørt sted, hvor den ikke udsættes for direkte sollys.

## GARANTI OG FRIVILLIG PRODUCENTGARANTI

WOW TECH EUROPE GMBH tilbyder kunderne en frivillig producentgaranti til dette produkt ud over den lovmæssige garanti, som forbrugere har ret til fra forhandlerens side.

Betingelserne vedrørende den frivillige producentgaranti findes på vores hjemmeside under "Garantibetingelser".

## OVERHOLDELSE AF STANDARDER

Dette apparat overholder alle standarder vedrørende elektromagnetisk kompatibilitet (EMC). Enheden er sikker at bruge, så længe den anvendes korrekt og i overensstemmelse med anvisningerne i denne brugermanual.

## BESKYTTELSE AF MILJØET

Som distributør af elektroniske enheder er vi juridisk forpligtet til at acceptere returnering af affald af elektriske og elektroniske enheder gratis. Vi erklærer udtrykkeligt, at du som bruger er juridisk forpligtet til at returnere brugte batterier. Smid aldrig elektronisk udstyr eller batterier ud med husholdningsaffaldet. Nedenstående symbol, der også findes på vores elektroniske genstande, har til formål at minde dig om dette.

## FORHANDLER

WOW Tech Europe GmbH,  
Friedenstrasse 91 / 91 a, 10249 Berlin, Tyskland

WOW Tech Europe GmbH forbeholder sig ret til at foretage tekniske ændringer og ændringer i designet med det formål at forbedre enheden.

Distribueret i Nordamerika af WOW TECH Canada Ltd. 1545 Carling Avenue, Suite 401, Ottawa ON, Canada K1Z 8P9

[www.wowtech.com](http://www.wowtech.com) Designet i Tyskland. Fremstillet i Kina i 2021. Manual udstedet i 02/2021. Version 1.

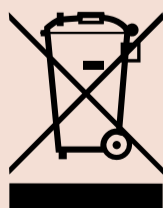

# VIL DU HAVE MERE?

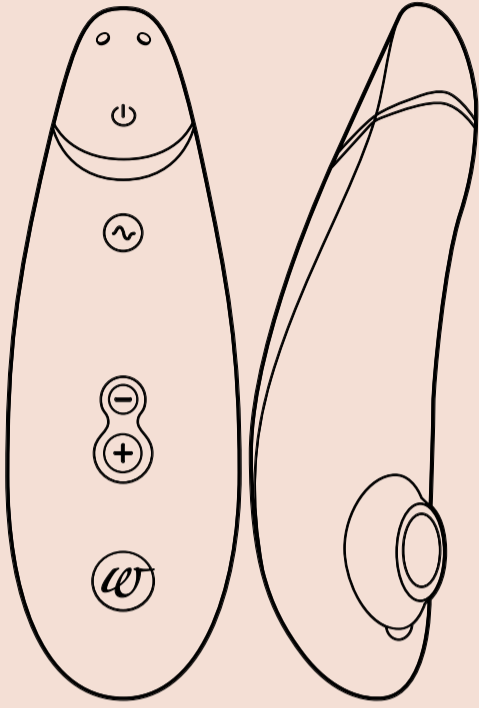

**Pleasure Air  
Technology**



**Smart Silence**

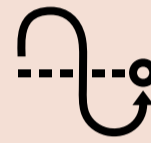

**Autopilot**

## **Premium 2**

Define your luxury

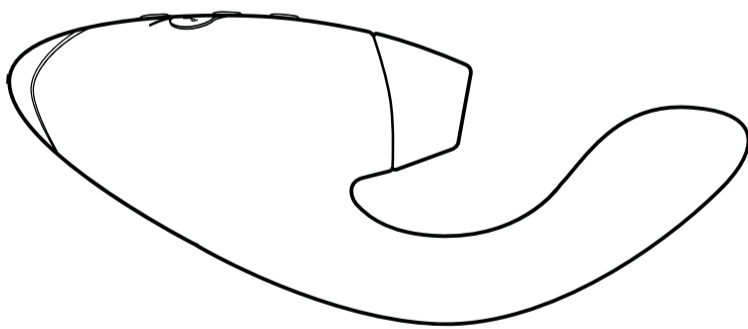

**Pleasure Air  
Technology**



**Vibrator**

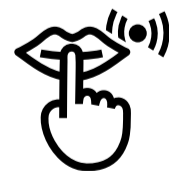

**Smart Silence**

## **DUO**

Double your Pleasure



**#IMASTURBATE**

# Hei!

**Takk for at du valgte Womanizer!**

Velkommen til en verden full av sensuelle opplevelser som vil berike livet ditt. Ved å velge WOMANIZER er du ikke bare garantert orgasmer som er uten sammenligning – men også et nytt begjær til pur glede.

**Kos deg med WOMANIZER – få den ene orgasmen etter den andre.**

Start nå, elsk deg selv!



**PRODUKTBESKRIVELSE**

**HVORDAN BRUKE DEN**

**LADING**

**RENGJØRING**

**GENERELL INFORMASJON**



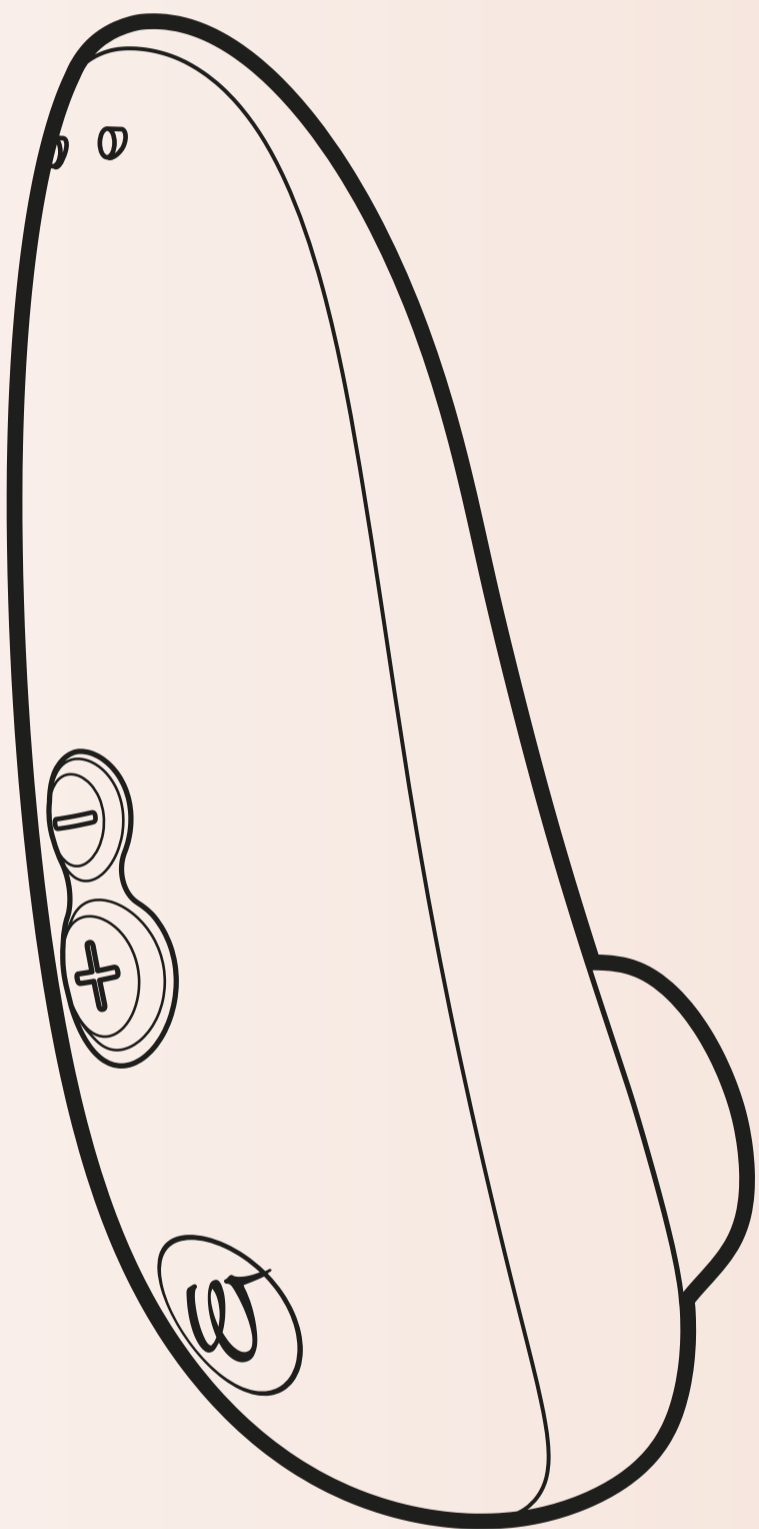

# PRODUKTBESKRIVELSE

**Magnetiske  
ladepins**

**Av**  
trykk i 2 sekunder

**Reduser intensiteten**  
trykk kort

**PÅ**  
trykk i 2 sekunder

**Øk intensiteten**  
trykk kort

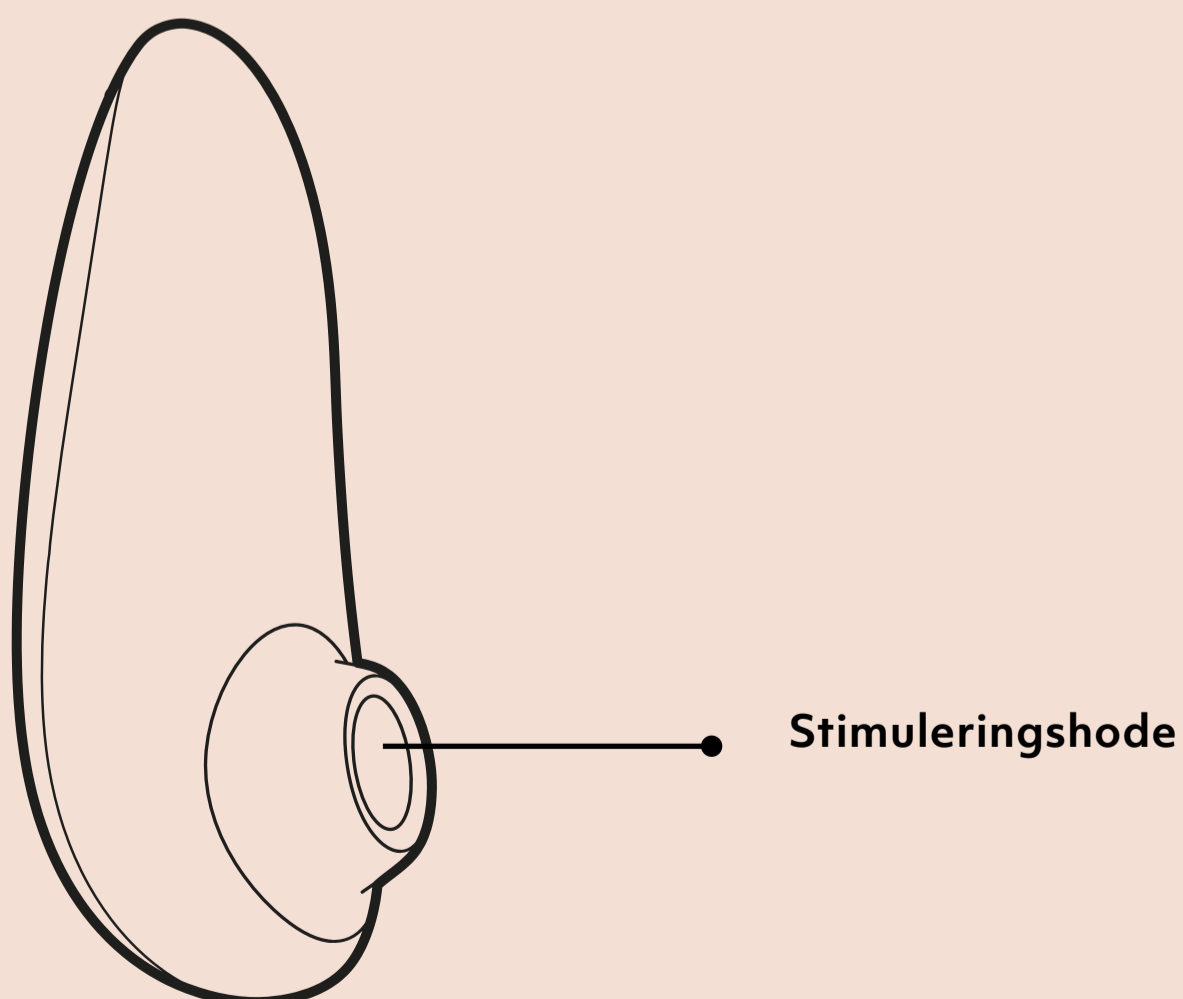
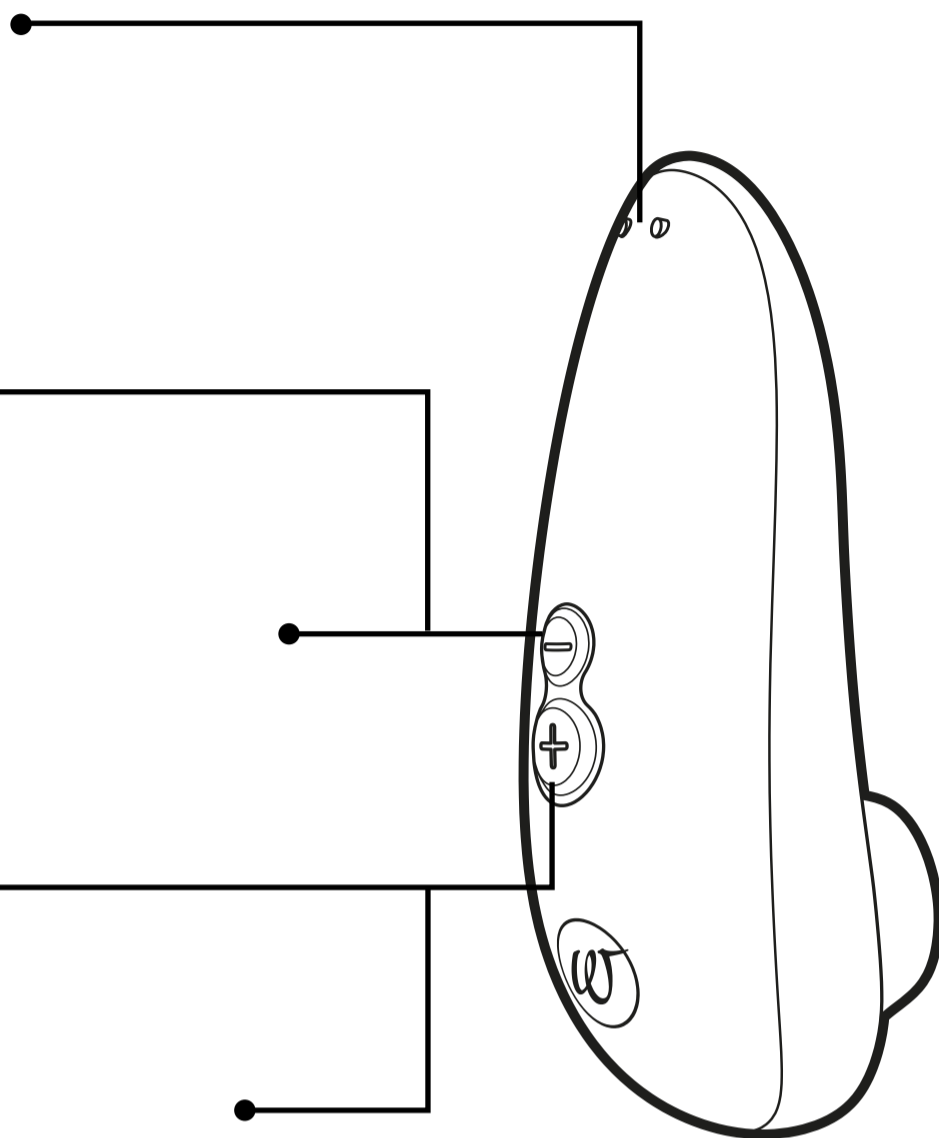

# HVORDAN BRUKE DEN

## 1. Slå på

Trykk i  
2 sekunder

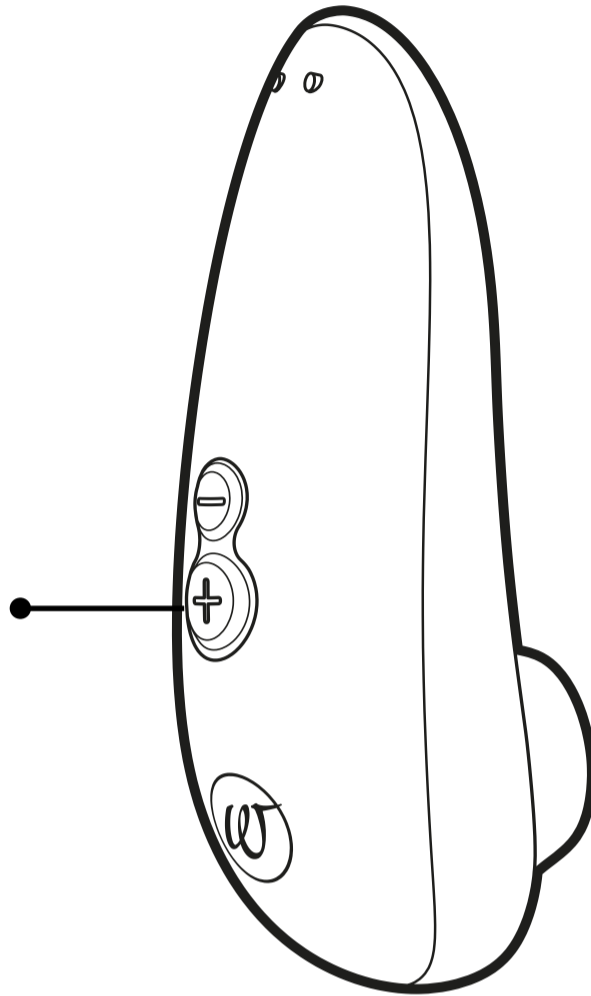

## 2. Bruk

Omfavn klitoris med stimuleringshodet, og la eventyret begynne.

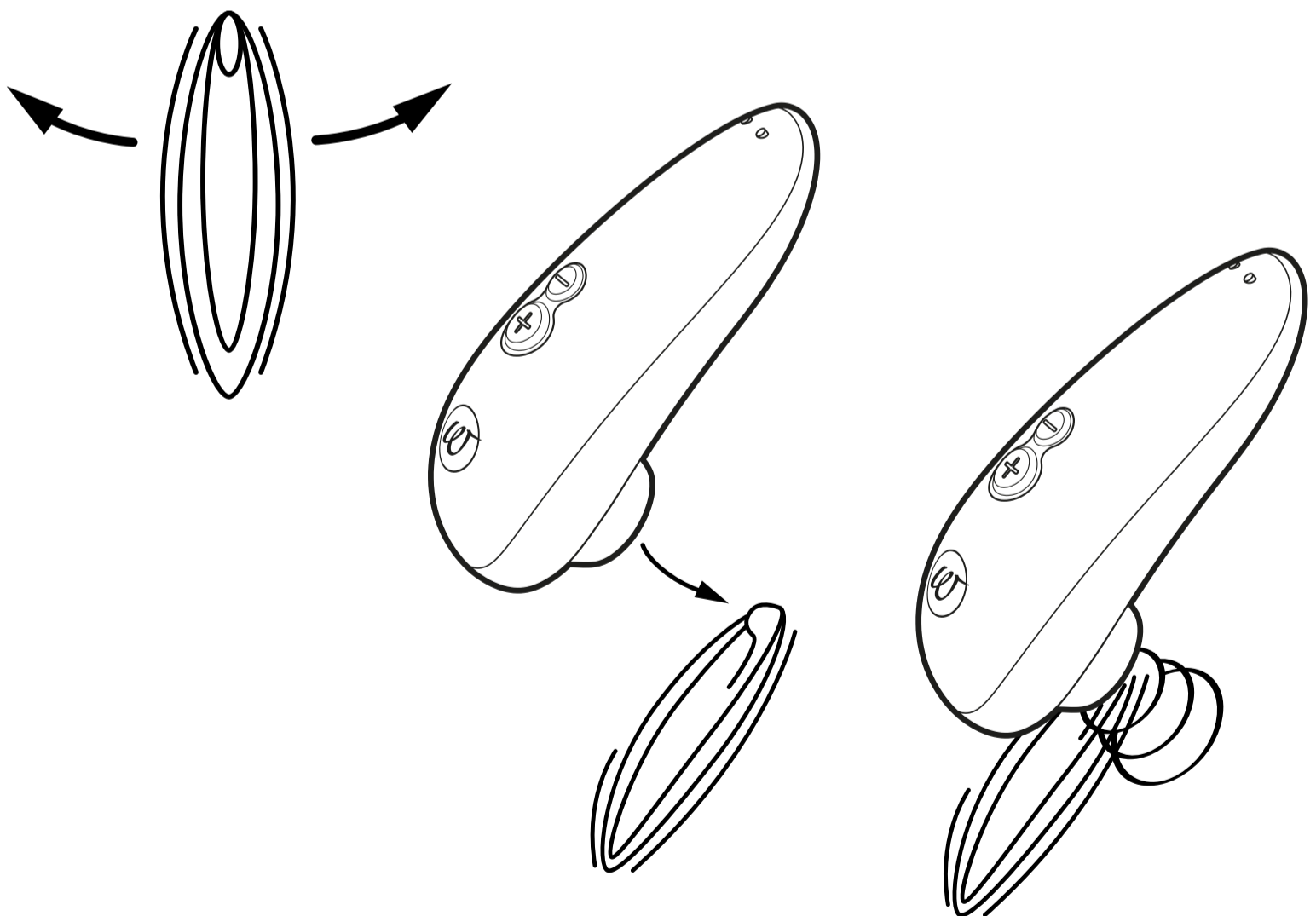

### 3. Endre intensitet

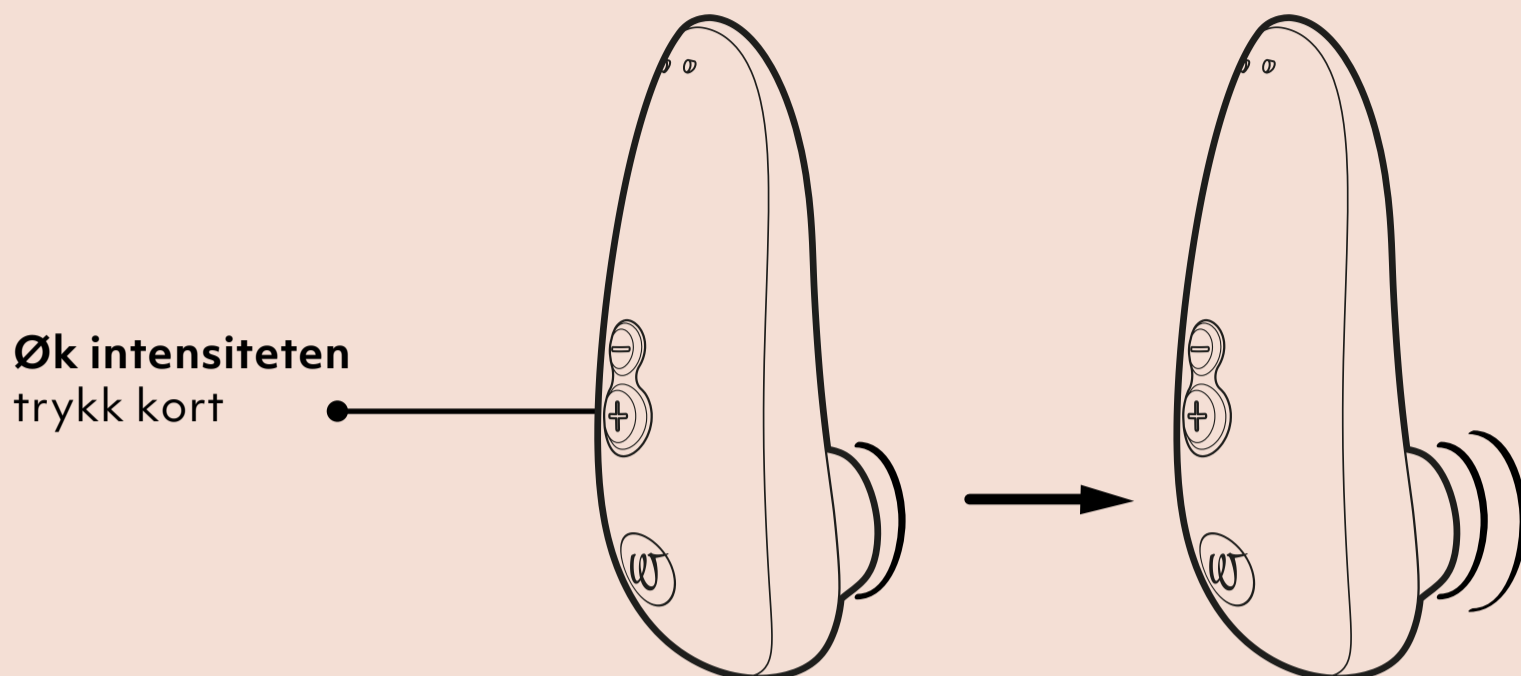

### 6 ⇄ Intensitetsnivåer

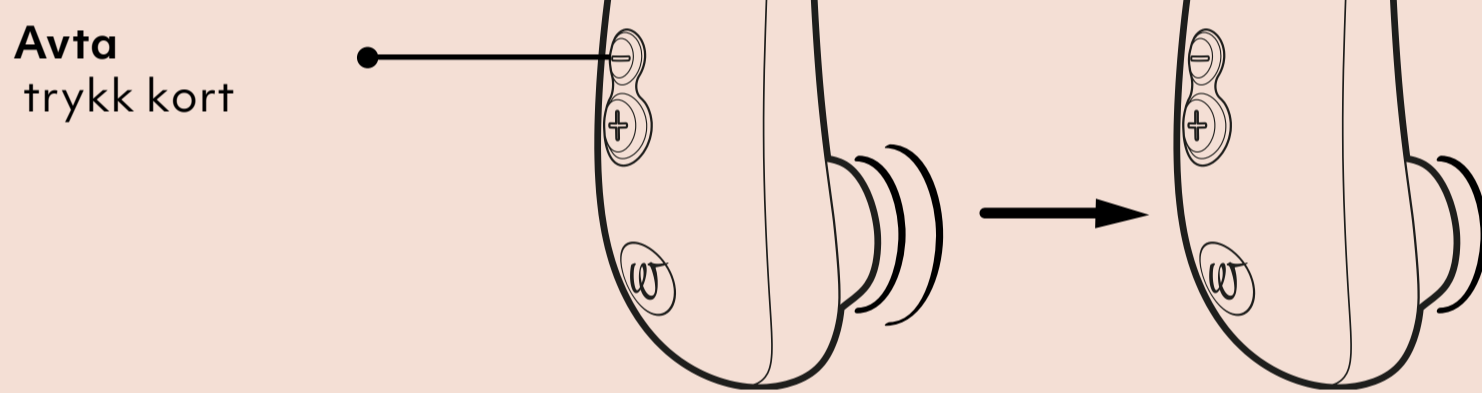

### 4. Slå av

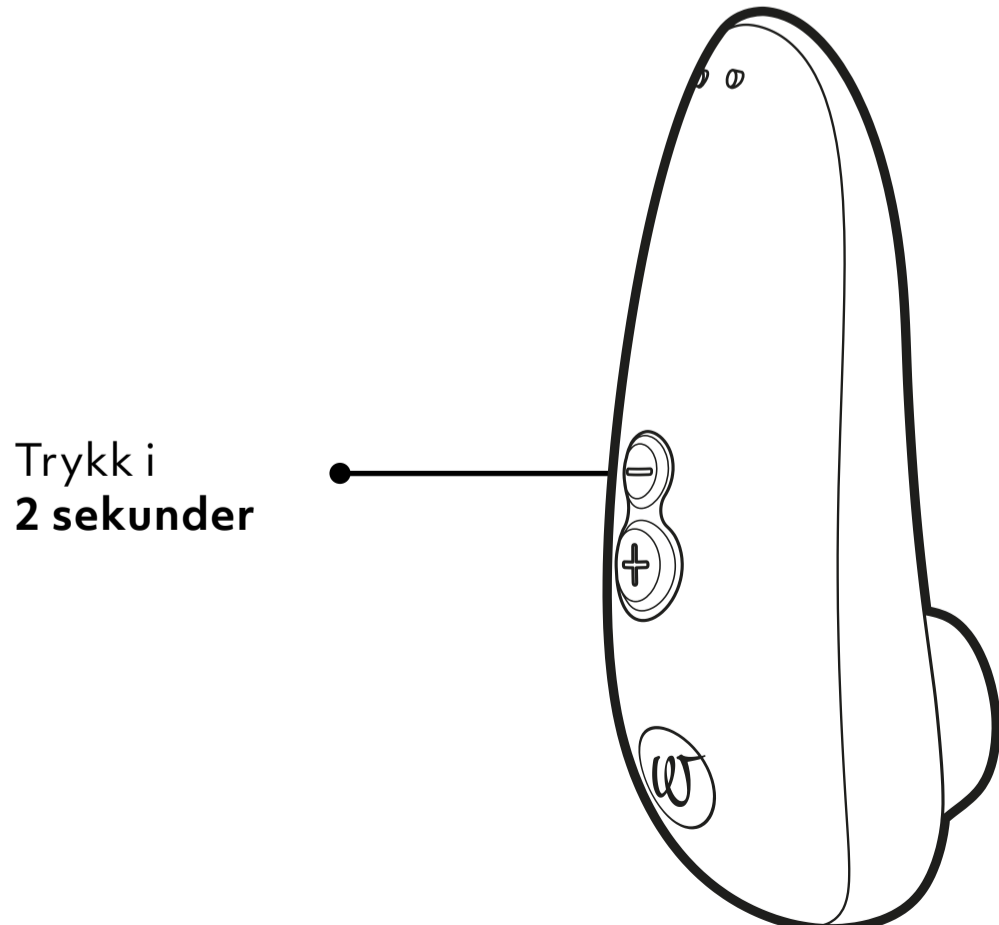

# LADING

Lad Womanizer før første gangs bruk. Husk også å lade Womanizer regelmessig for å sikre lang batterilevetid.

**Opladning**  
via USB port

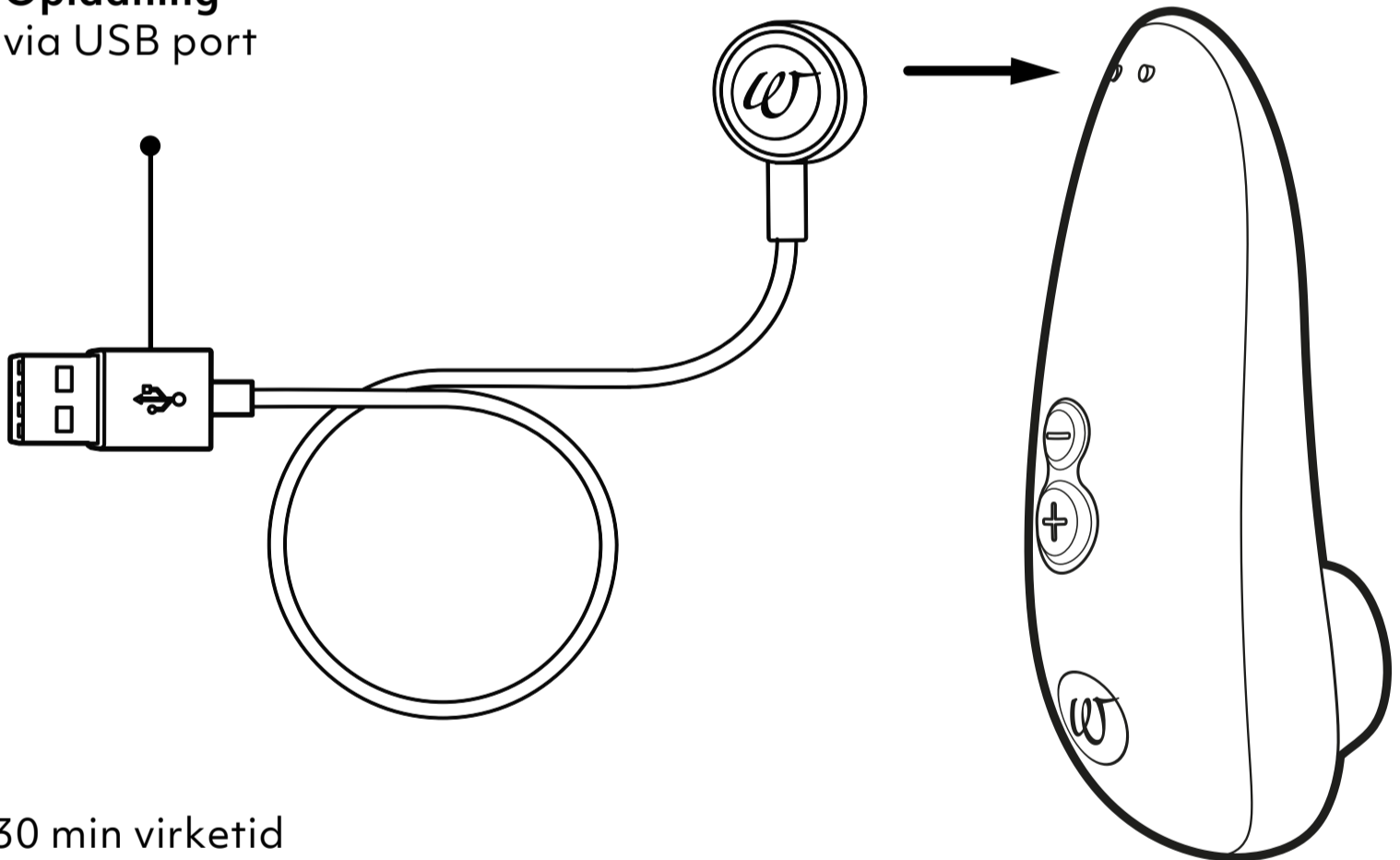

30 min virketid  
30 min når fulladet

# RENGJØRING

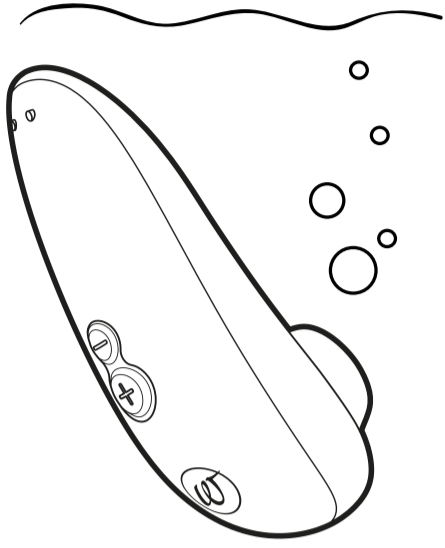

vaskes under vann

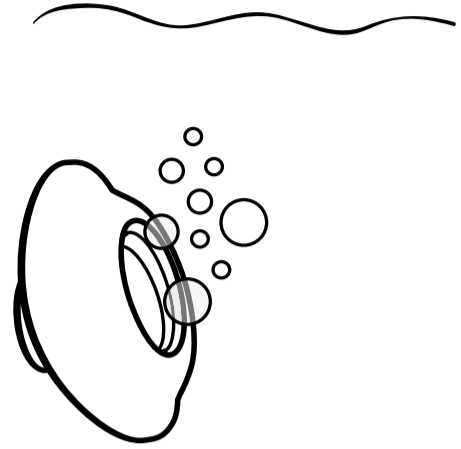

vaskes under vann

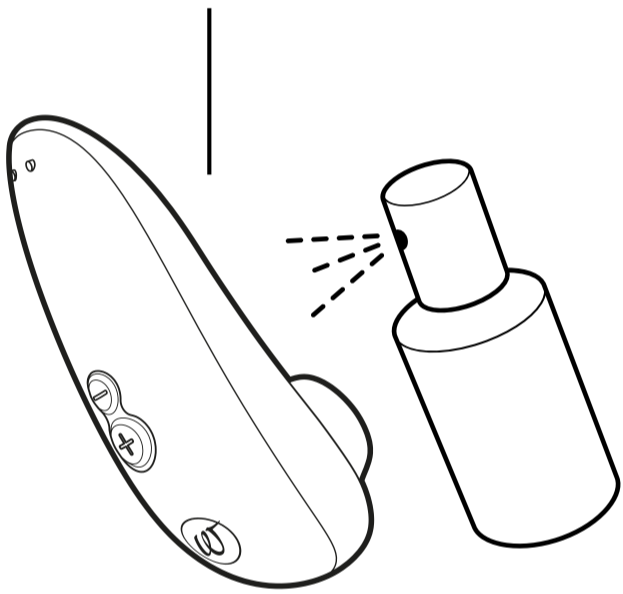

Påfør toy-cleaner

+

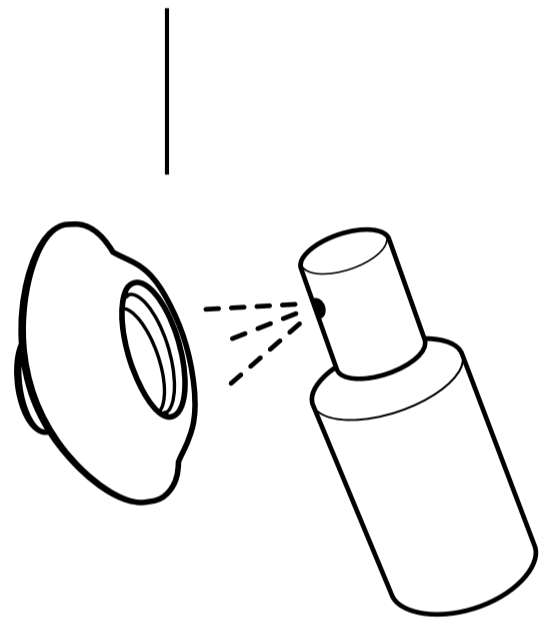

Påfør toy-cleaner

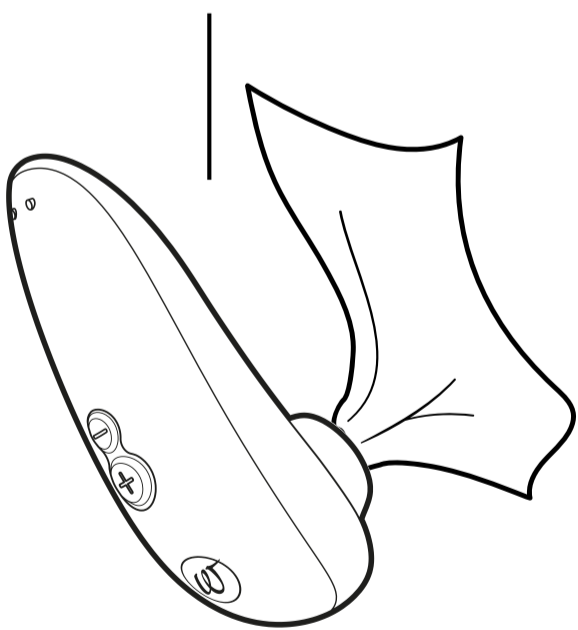

Tørke

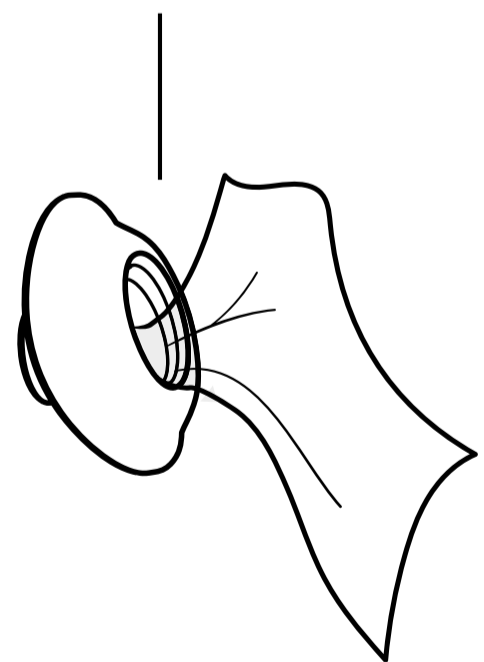

Tørke



Waterproof  
IPX7

# GENERELL INFORMASJON

## ADVARSEL

For å unngå skade, ikke bruk parfymerte, alkohol- eller silisiumbaserte smøregeler eller massasjeoljer mens du bruker Womanizer.

Rengjør Womanizer grundig før du bruker den for første gang og etter hver bruk for å redusere risikoen for infeksjon.

## KUNDESERVICE

For mer informasjon, besøk vår nettside [www.womanizer.com](http://www.womanizer.com) eller kontakt [care@womanizer.com](mailto:care@womanizer.com).

## TEKNISKE SPESIFIKASJONER

Modell: WZ15B

Elektrisk vurdering: 3,7  $\approx$  0,135 A:

Innebygd oppladbart litiumionbatteri.

5 V  $\approx$  0,75 A: Når det lades med USB.

Ladeapparat:

USB-strømadapter (ikke inkludert) med strømuttak som tilsvarer produktvurdering. Ikke bruk hurtiglade-adapter.

## INNHold I LEVERANSEN

Womanizer Starlet 3, USB-ladekabel, hurtigstart-guide, sikkerhetsinstruksjoner.

## OPPBEVARING

Oppbevares på et trygt, tørt sted uten direkte sollys.

## GARANTI OG FRIVILLIG PRODUSENTGARANTI

WOW TECH EUROPE GMBH tilbyr kundene en frivillig produsentgaranti for dette produktet i tillegg til den lovpålagte garantien som forbrukerne har krav på med hensyn til selgere. Betingelsene med hensyn til den frivillige produsentens garanti finner du på nettstedet vårt under „Garantibetingelser“.

## OPPFYLLING AV STANDARDER

Dette apparatet oppfyller alle standarder angående elektromagnetisk kompatibilitet (EMC). Enheten er sikker å bruke så lenge den brukes riktig og i samsvar med instruksjonene gitt i denne brukerhåndboken.

## MILJØVERN

Som distributør av elektroniske enheter er vi juridisk forpliktet til å akseptere retur av avfall av elektriske og elektroniske apparater gratis. Vi gir uttrykkelig opplysning om at du som bruker er juridisk forpliktet til å returnere brukte batterier. Kast aldri elektroniske enheter eller batterier i husholdningsavfallet.

Symbolet vist nedenfor, som også er festet til våre elektroniske gjenstander, er ment å uttrykke en påminnelse om dette.

## DISTRIBUTØR

WOW Tech Europe GmbH,  
Friedenstrasse 91 / 91 a, 10249 Berlin, Germany“

WOW Tech Europe GmbH forbeholder seg retten til å gjøre tekniske endringer og endringer i designet som kan forbedre enheten.

Distribuert i Nord-Amerika av WOW TECH Canada Ltd. 1545 Carling Avenue, Suite 401, Ottawa ON, Canada K1Z 8P9

[www.wowtech.com](http://www.wowtech.com) Designet i Tyskland. Laget i Kina i 2021. Manual utstedt 02/2021. Versjon 1.

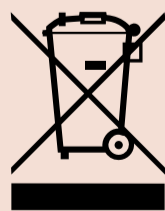

# ØNSKER DU MER?

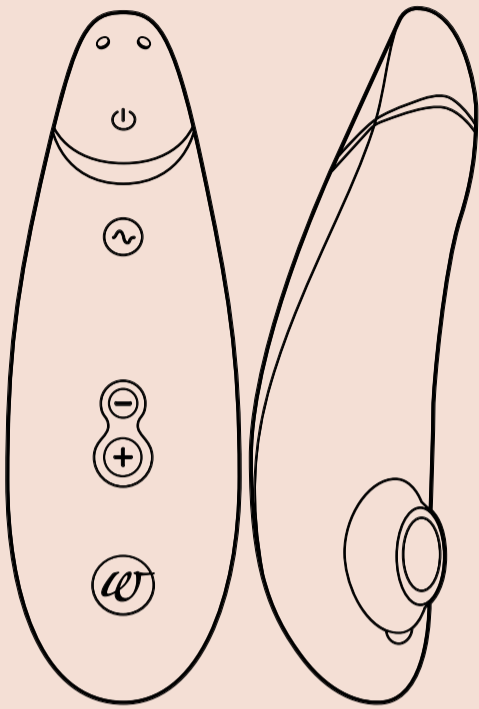

**Pleasure Air  
Technology**



**Smart Silence**

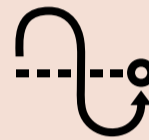

**Autopilot**

**Premium 2**  
Define your luxury

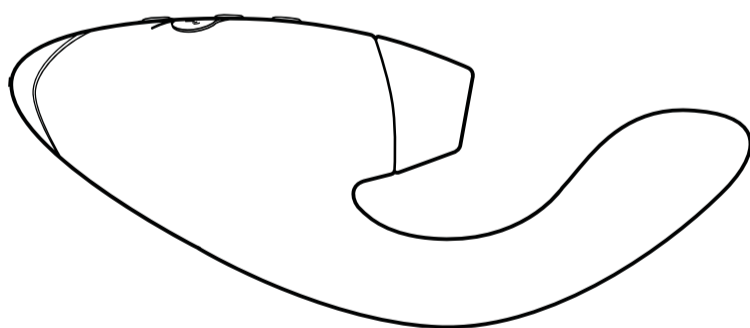

**Pleasure Air  
Technology**



**Vibrator**



**Smart Silence**

**DUO**  
Double your Pleasure





**#IMASTURBATE**

# 嗨！

**感谢您选择 Womanizer!**

欢迎探索快感迭起的情趣世界,生活从此更加丰富多彩。选择 WOMANIZER,您不仅可以享受无与伦比的美好高潮,还能拥有全新的欢愉欲望。

**享受 WOMANIZER - 带给您一次又一次的高潮**

好好爱自己!



产品说明  
如何使用  
充电  
清洁  
一般信息

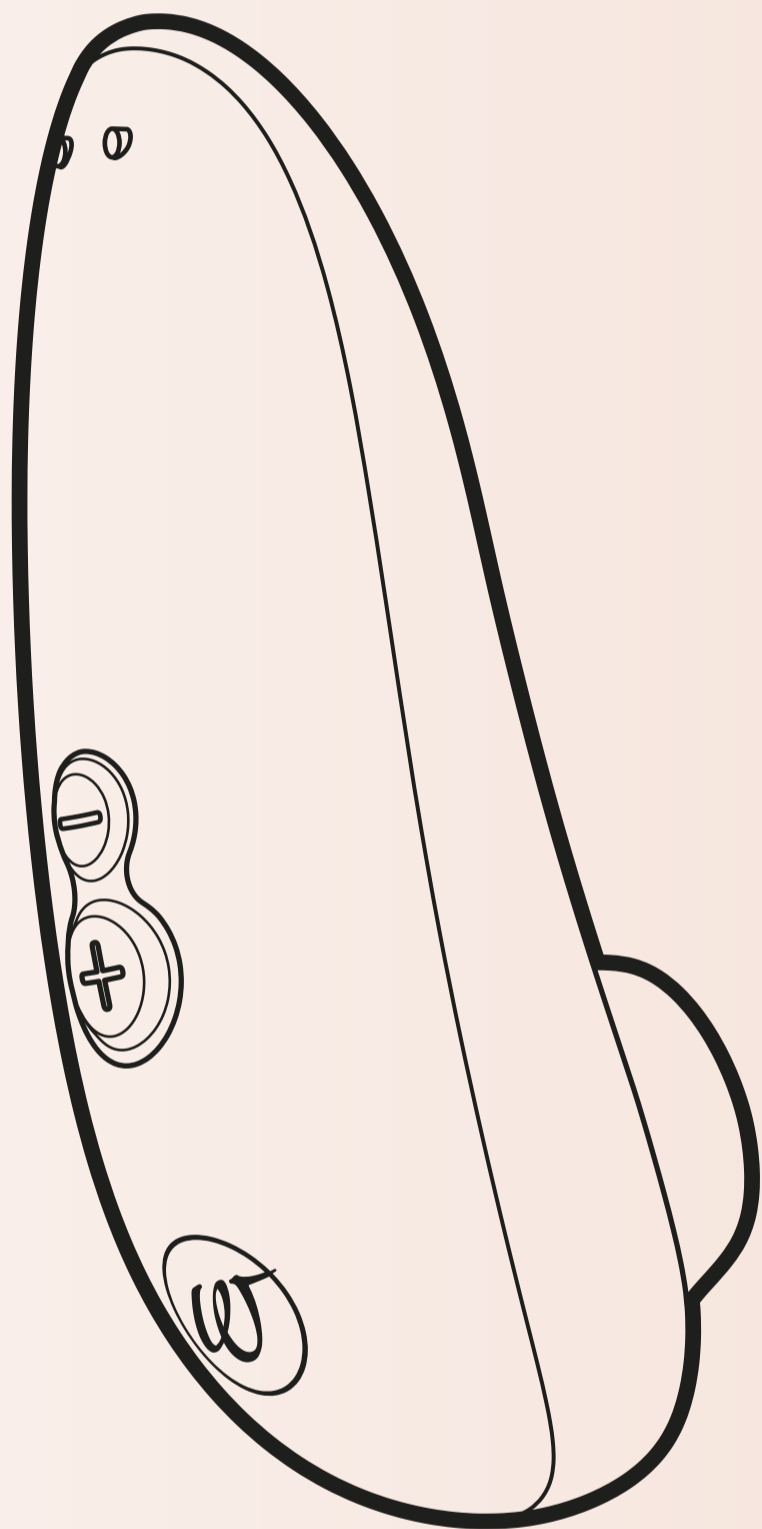

# 产品说明

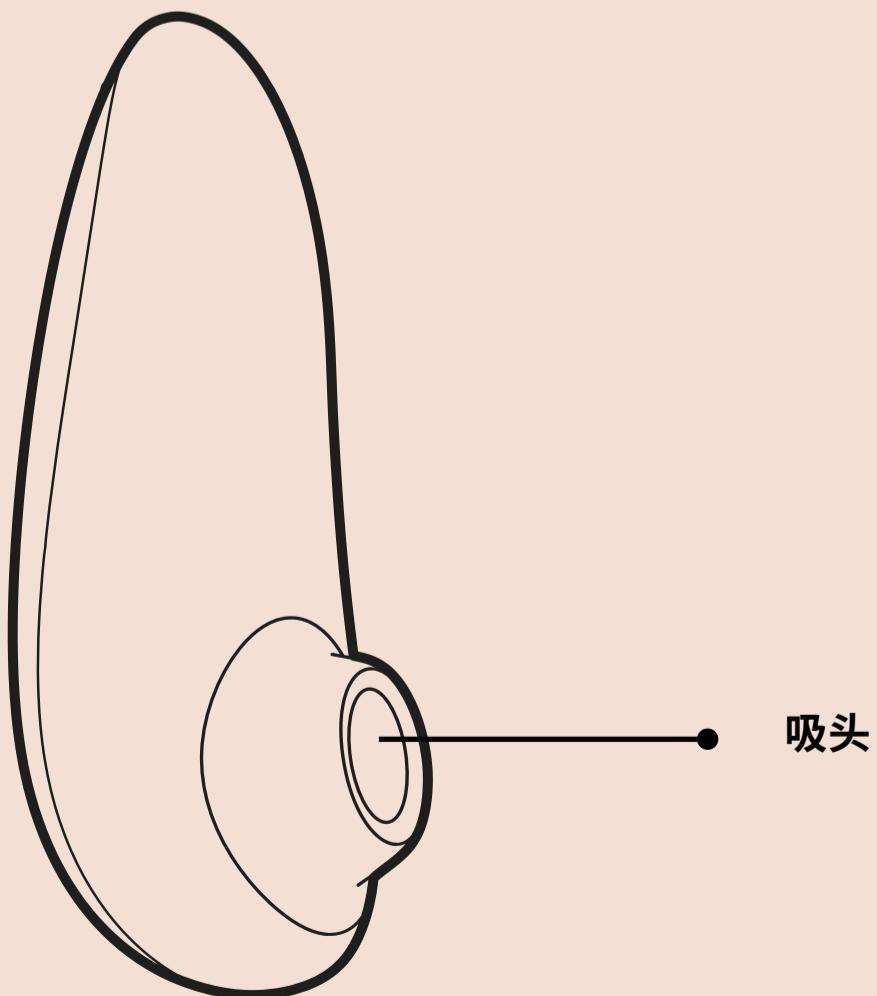
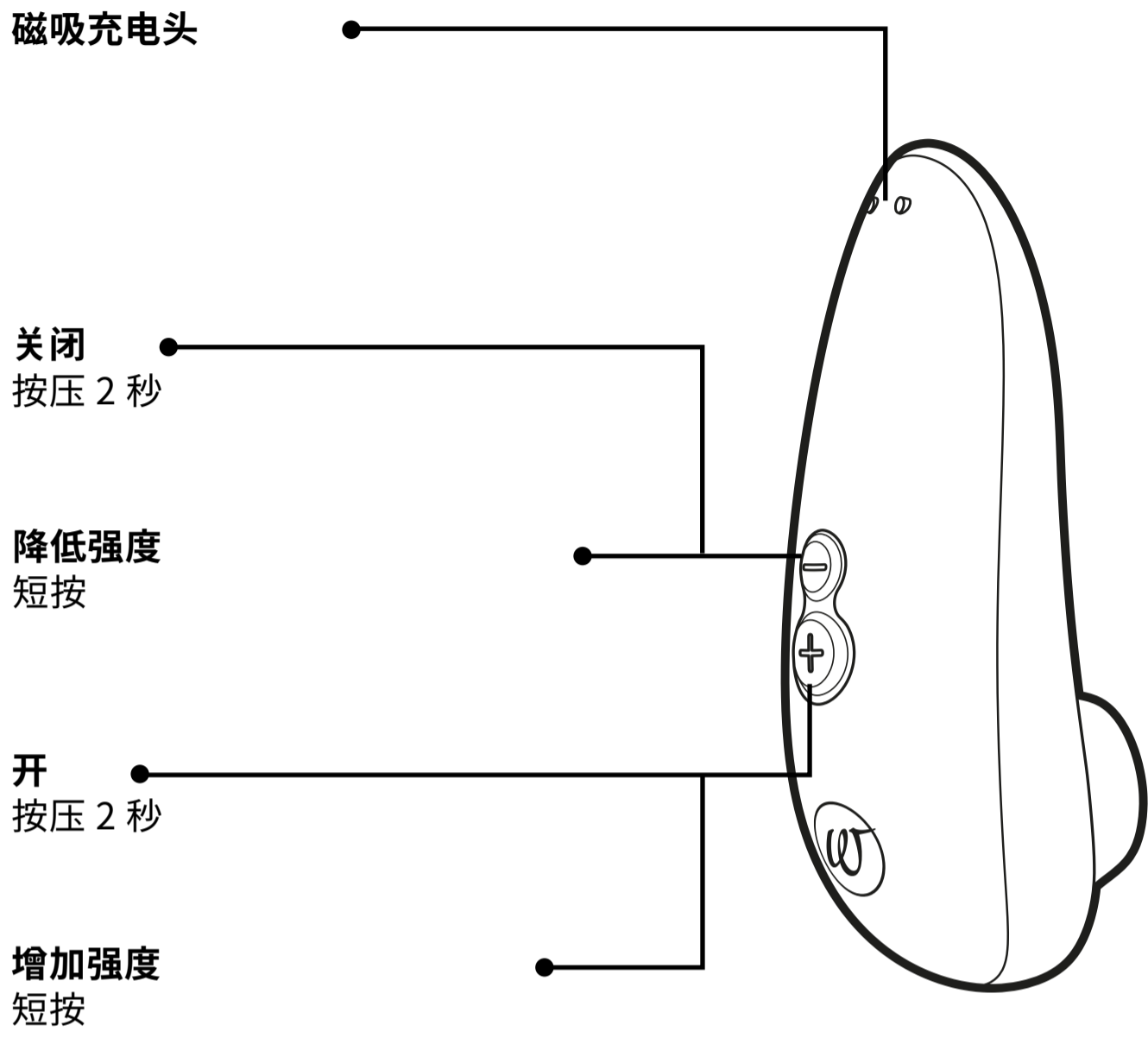

# 如何使用

## 1. 开启电源

按压  
2 秒

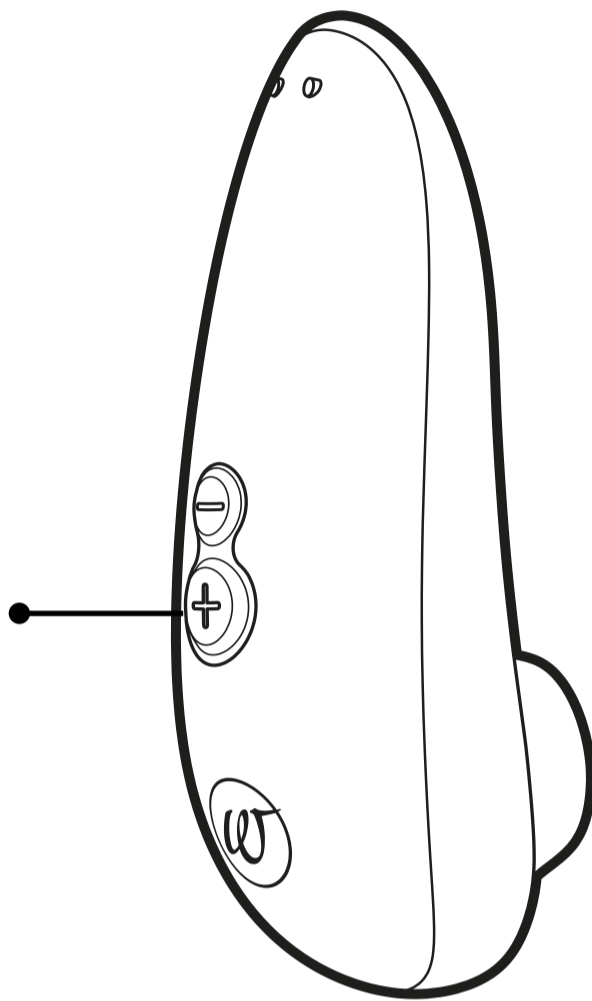

## 2. 使用方法

用吸吮包围阴蒂, 开启享受之旅。

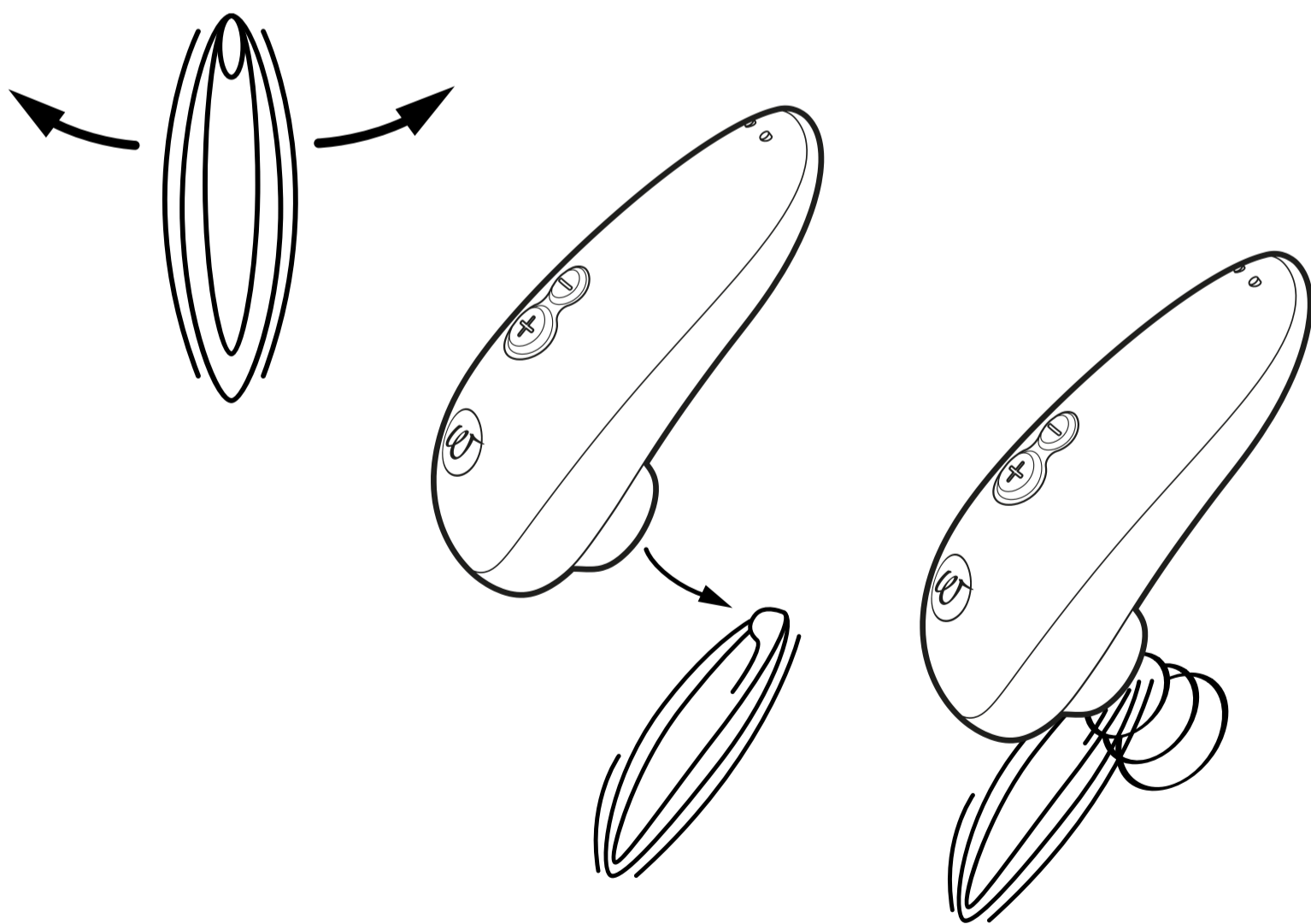

### 3. 改变强度

增加  
短按

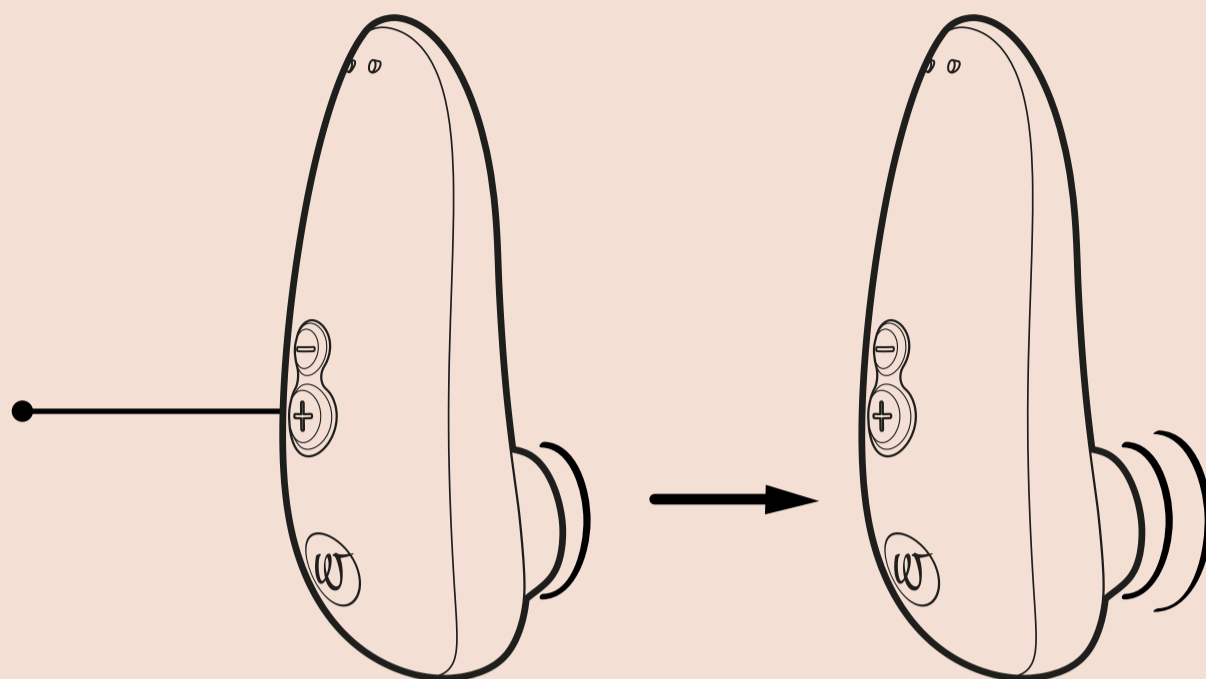

6  强度选择

降低  
短按

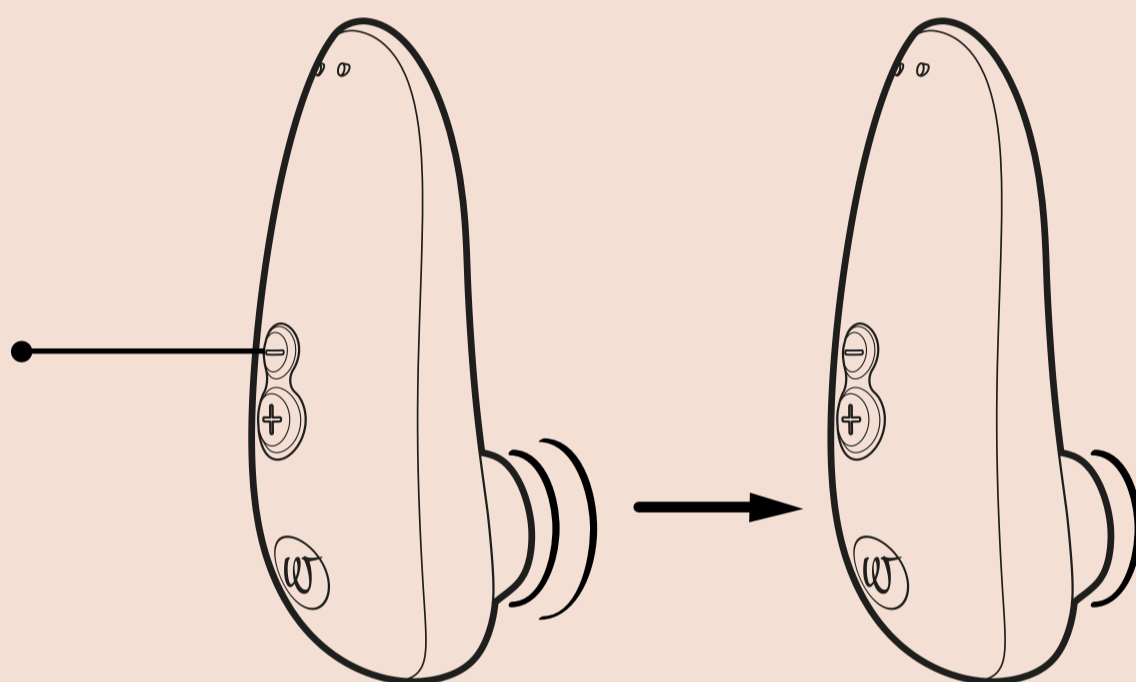

### 4. 关闭

按压  
2 秒

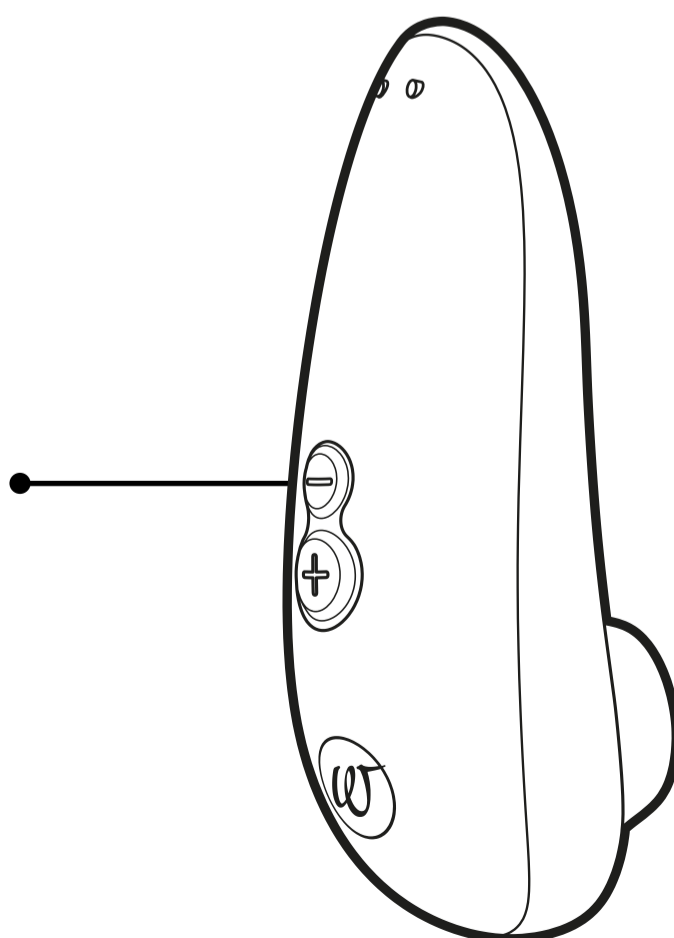

# 充电

请在首次使用前为您的 Womanizer 充电。同时也请记住应定期为 Womanizer 充电, 确保电池能保有较长寿命。

充电  
通过 USB 接口

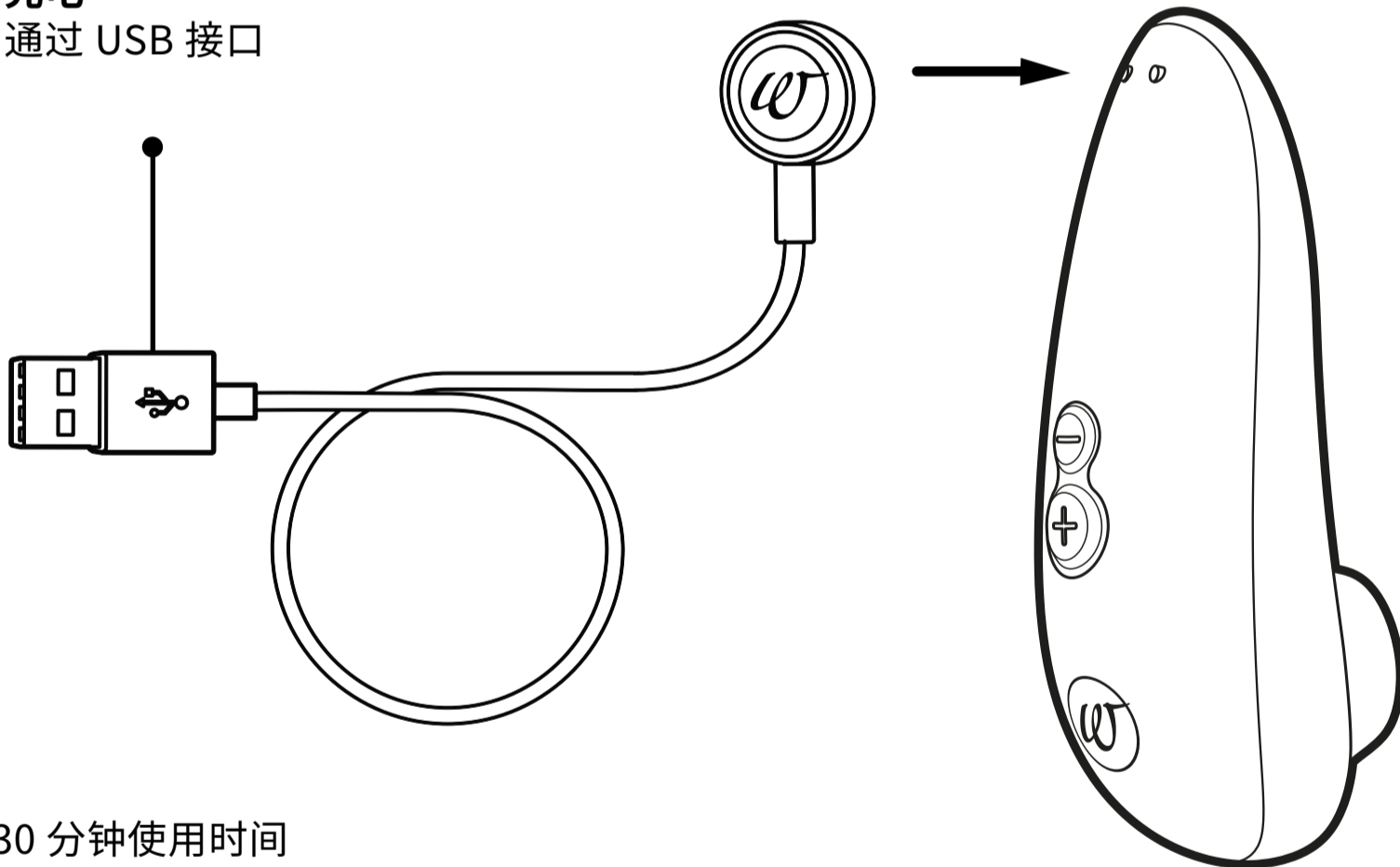

30 分钟使用时间  
30 分钟充满电



# 清洁

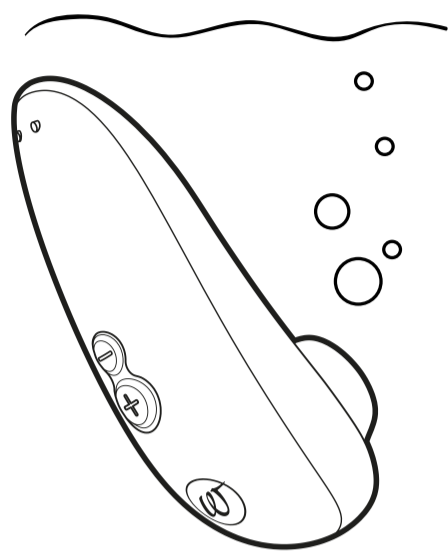

在水中清洗

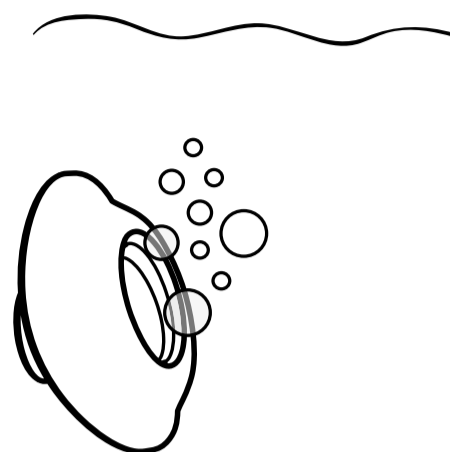

在水中清洗

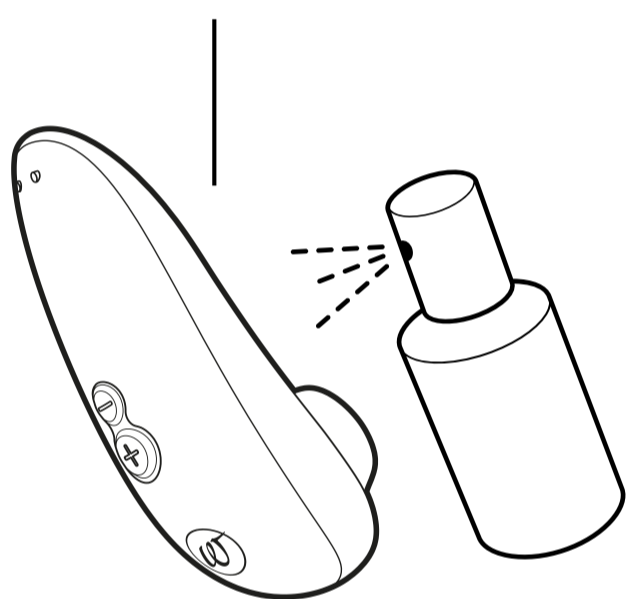

喷涂情趣玩具清洁剂

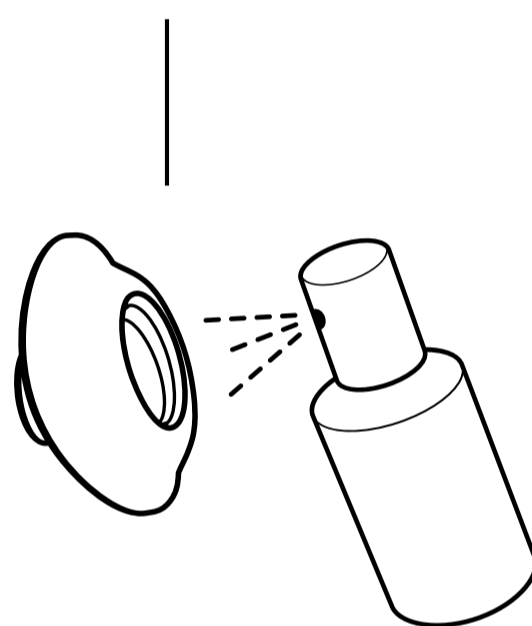

喷涂情趣玩具清洁剂

+

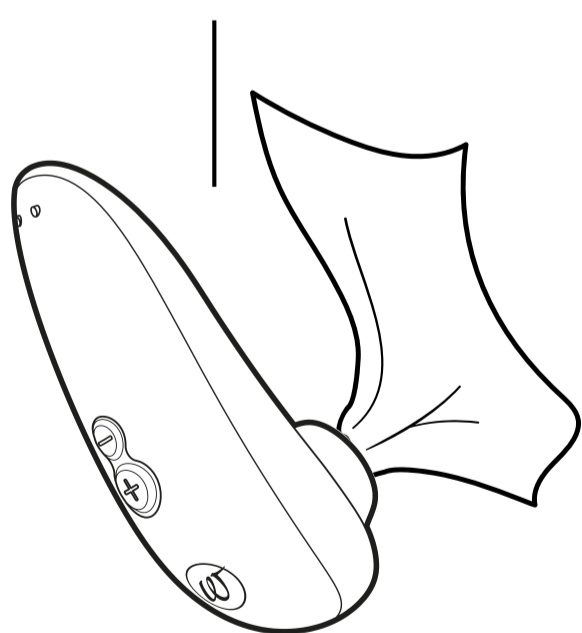

干燥

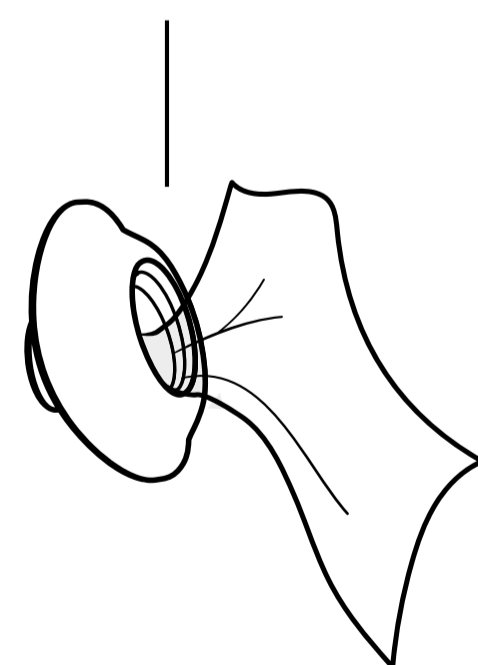

干燥



Waterproof  
IPX7

# 一般信息

## 警告

使用 Womanizer 時，請勿使用含有香水、酒精或矽酮的潤滑劑或按摩油，以免損壞。  
首次使用前和每次使用后，請徹底清潔 Womanizer，以降低感染風險。

## 客戶服務

若需要更多信息，請訪問我們的網站 [www.womanizer.com](http://www.womanizer.com) 或聯繫 [care@womanizer.com](mailto:care@womanizer.com)。

## 技術規格型號

型號：WZ15B  
電功率額定值：3.7 W ± 0.135 A：  
內建鋰離子充電電池。  
5 V ± 0.75 A：使用 USB 充電時。  
充電裝置：  
輸出功率與產品額定值相符的 USB AC 轉接器（不含在內）。請勿使用快速充電轉接器。

## 包裝內容

Womanizer Starlet 3、USB 充電線、快速入門指南、安全說明書。

## 儲存

儲存在安全、乾燥的地方，避免陽光直射。

## 保固和製造商

### 自願保固

除了製造商為消費者提供的法定保固外，WOW TECH EUROPE GMBH 還為客戶提供針對本產品的製造商自願保固。  
關於製造商自願保修的條件，請參見我們網站上的“保修條件”。

## 合規性

本設備符合所有電磁兼容性 (EMC) 相關標準。只要按照本用戶手冊中的說明正確使用本設備，就能確保使用安全。

## 環境保護

作為電子設備的經銷商，我們在法律上有義務免費協助回收廢棄電器與電子設備。我們明確聲明，用戶有法律義務回收廢舊電池。切勿將電子設備或電池作為生活垃圾丟棄。  
下图所示的符号（我们的电子产品上也有标示）正是为了明确提醒注意环保义务。

## 分銷商

WOW Tech Europe GmbH,  
Friedenstrasse 91 / 91 a, 10249  
Berlin, Germany (德國)

WOW Tech Europe GmbH 保留為改進設備而變更技術或設計的权利。

北美經銷商：WOW TECH Canada Ltd.  
1545 Carling Avenue, Suite 401, Ottawa  
ON, Canada K1Z 8P9 (加拿大)

[www.wowtech.com](http://www.wowtech.com) 德國設計。中國製造（2021 年）。手冊於 02/2021 發行。第 1 版。

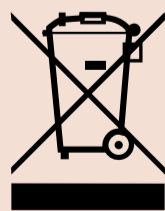

# 还想要更多？

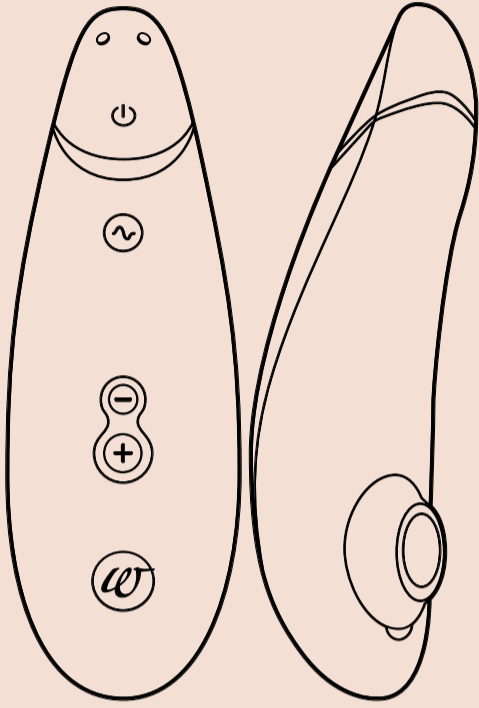

**Pleasure Air  
Technology**



**Smart Silence**

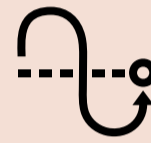

**Autopilot**

**Premium 2**  
Define your luxury

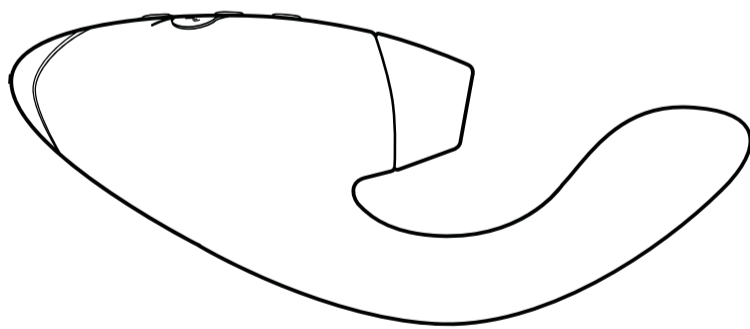

**Pleasure Air  
Technology**



**Vibrator**



**Smart Silence**

**DUO**  
Double your Pleasure



**#IMASTURBATE**

# 어서 오세요!

**Womanizer**를 선택해 주셔서 감사합니다!

삶에 풍요를 더해 줄 관능적 경험의 세계에 오신 것을 환영합니다. WOMANIZER을 선택하면, 최고의 오르가즘 뿐만 아니라 완전히 새로운 즐거움도 보장받을 수 있습니다.

**WOMANIZER**를 즐기세요. 오르가즘이 연속해서 파도처럼 밀려 옵니다.

망설이지 말고, 자신을 사랑하세요!



제품 설명

사용 방법

충전

청소

일반 정보

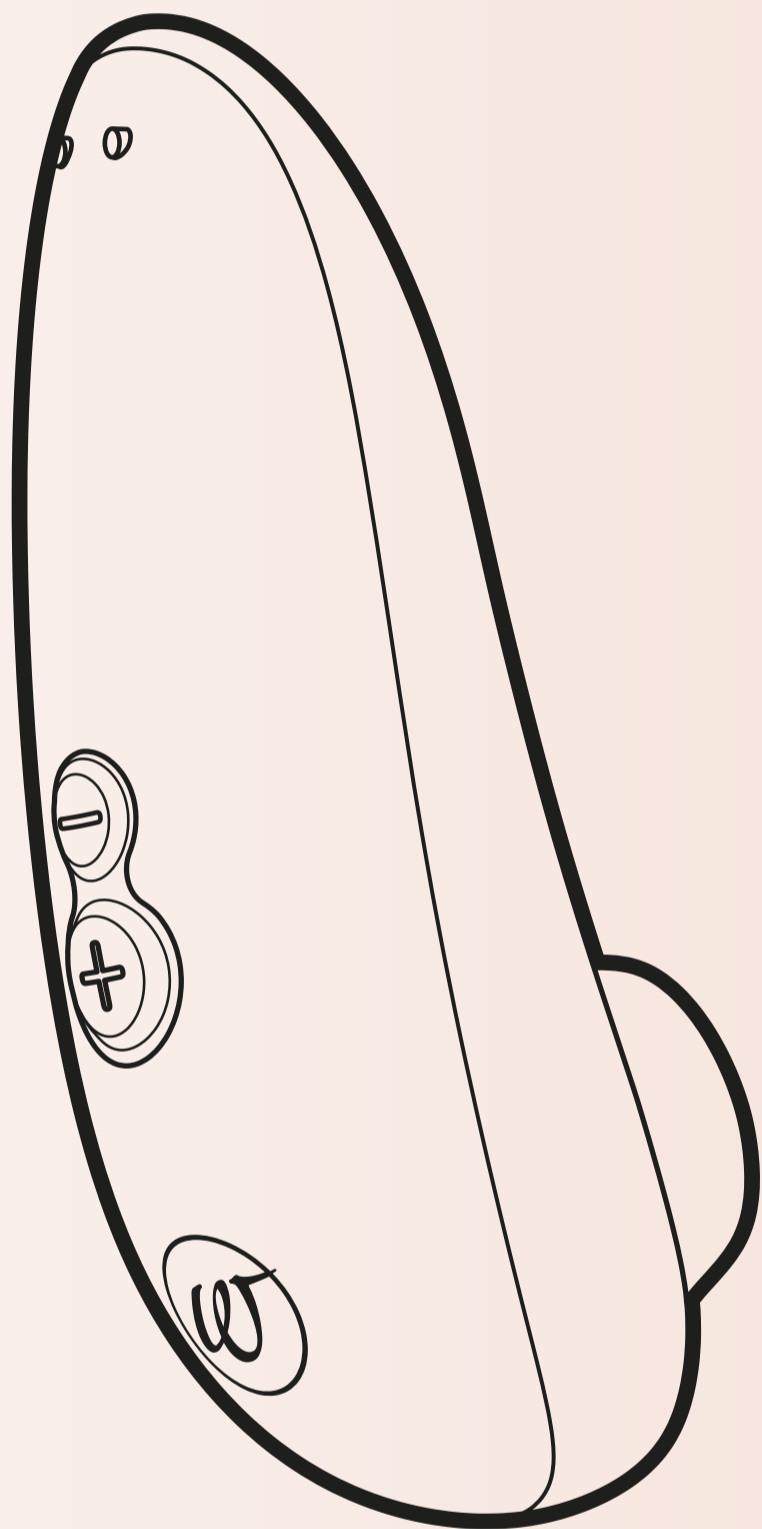

# 제품 설명

자기 충전 핀

끄기  
2 초 동안 누릅니다

강도 감소  
짧게 누릅니다

ON  
2 초 동안 누릅니다

강도 증가  
짧게 누릅니다

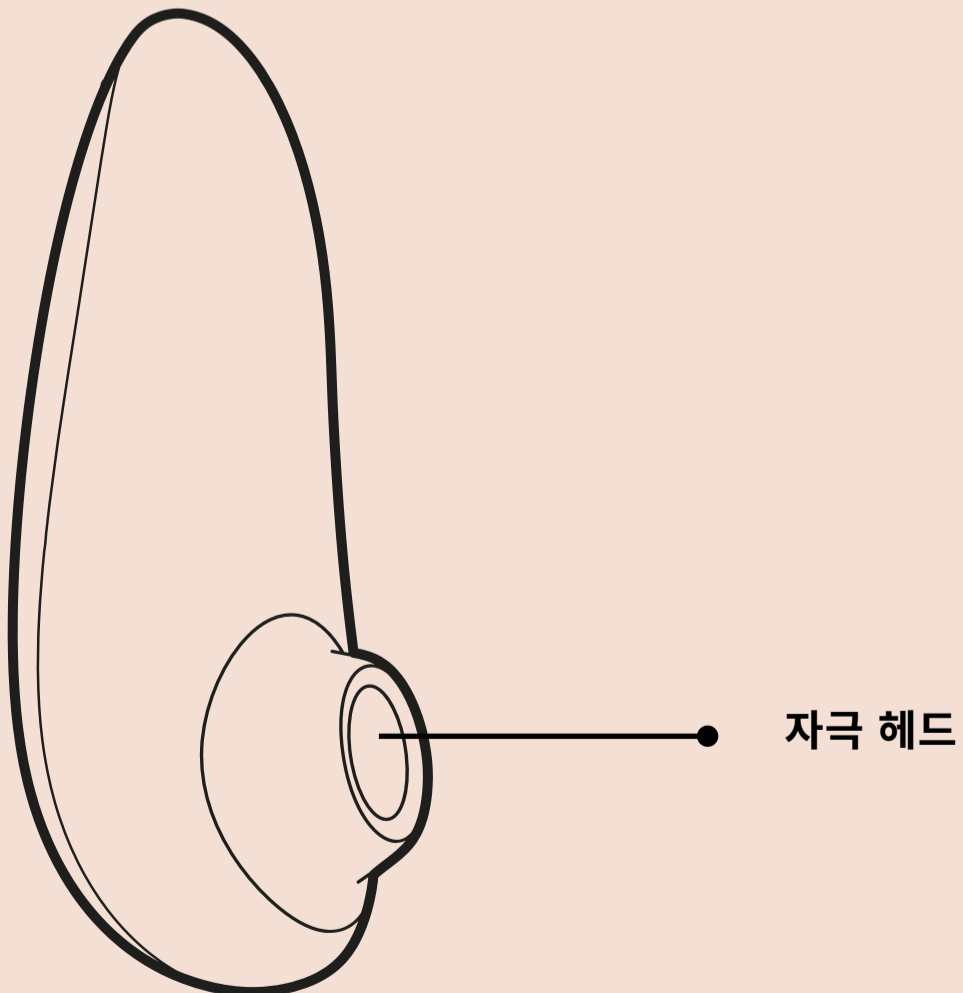
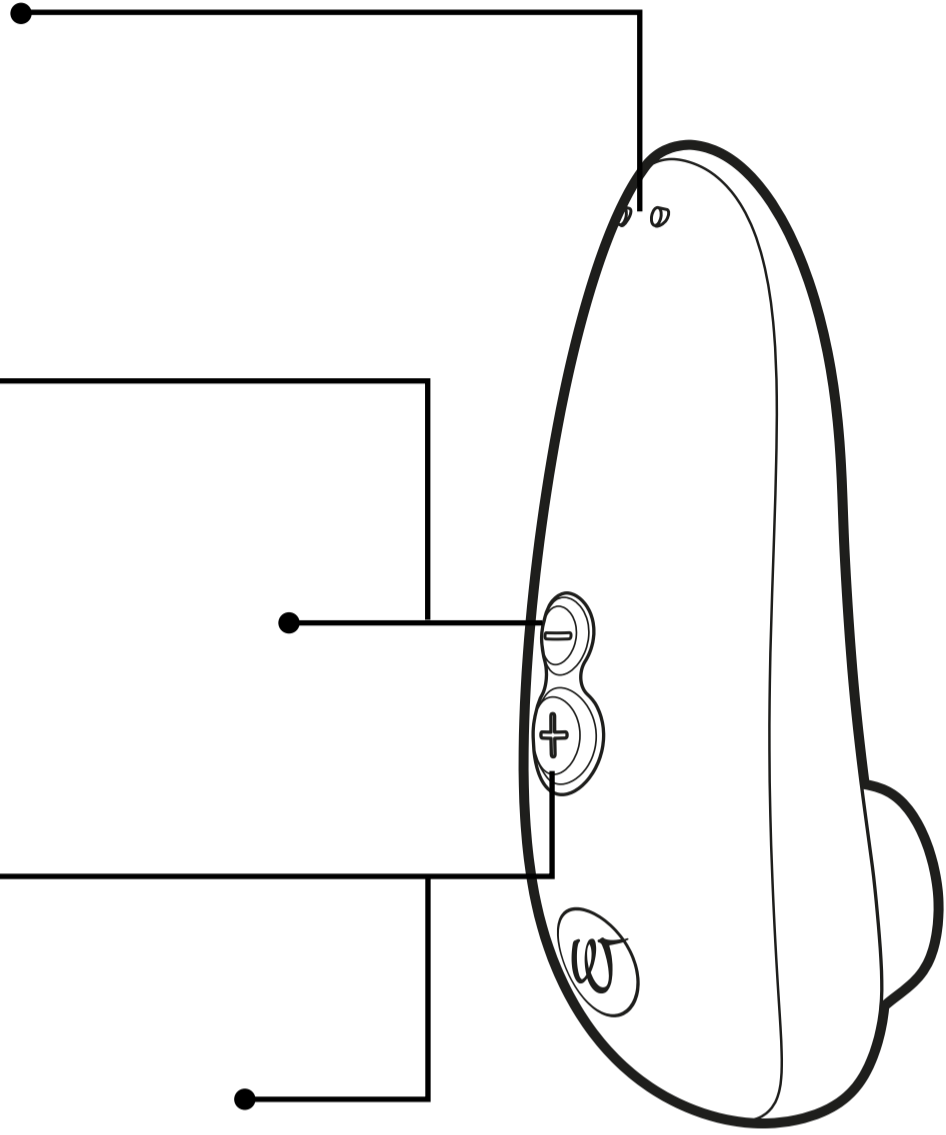

자극 헤드



# 사용 방법

## 1. 켜기

누릅니다  
2 초 동안

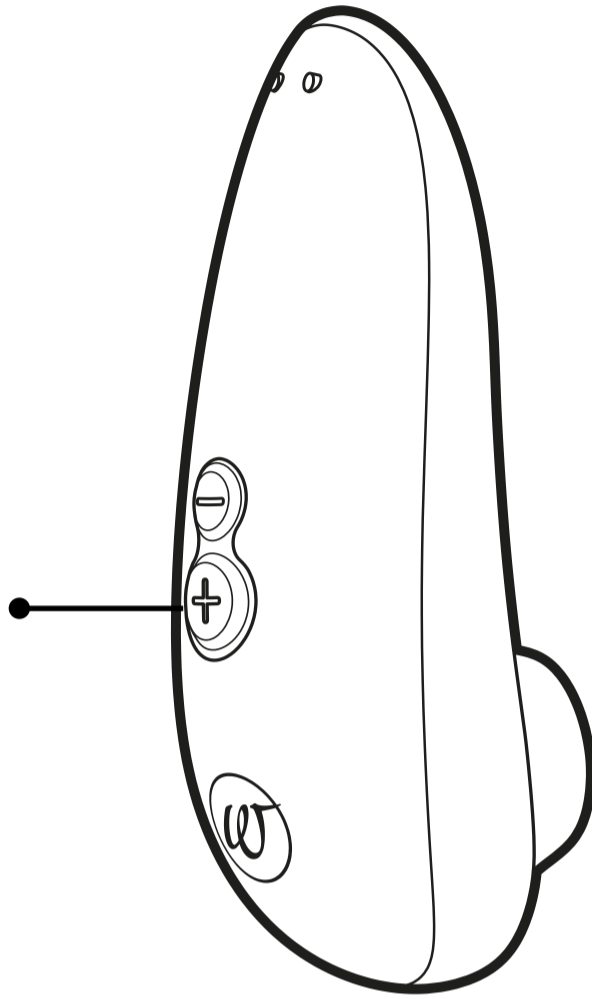

## 2. 사용

자극 헤드로 클리토리스를 감싸고 쾌감의 여정을 시작합니다.

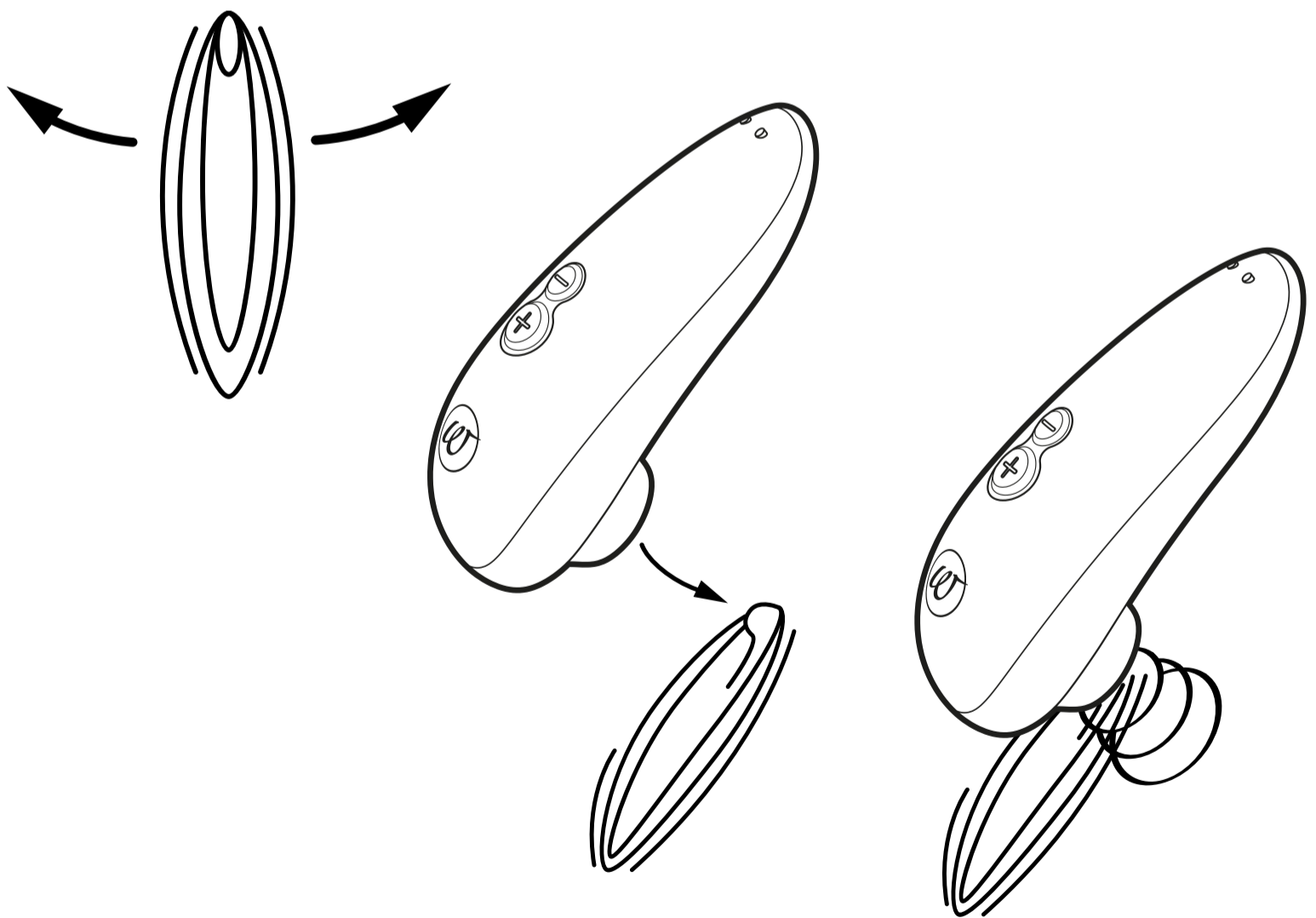

### 3.강도 변경

증가  
짧게 누릅니다

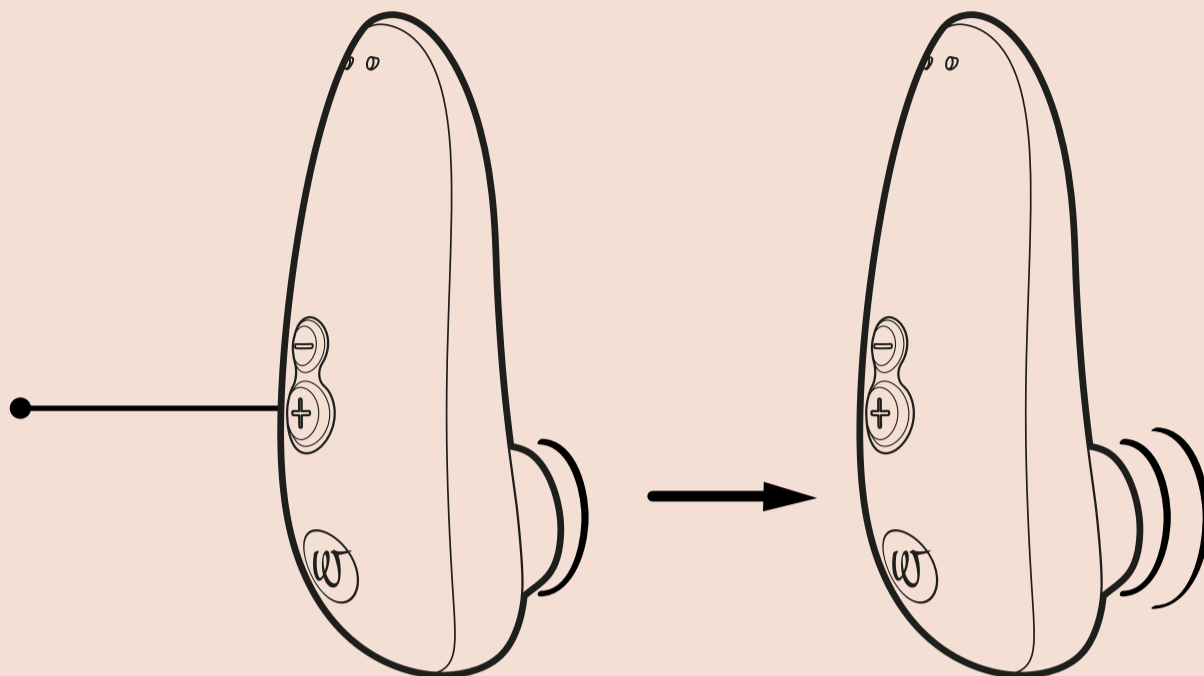

6  强度选择

감소  
짧게 누릅니다

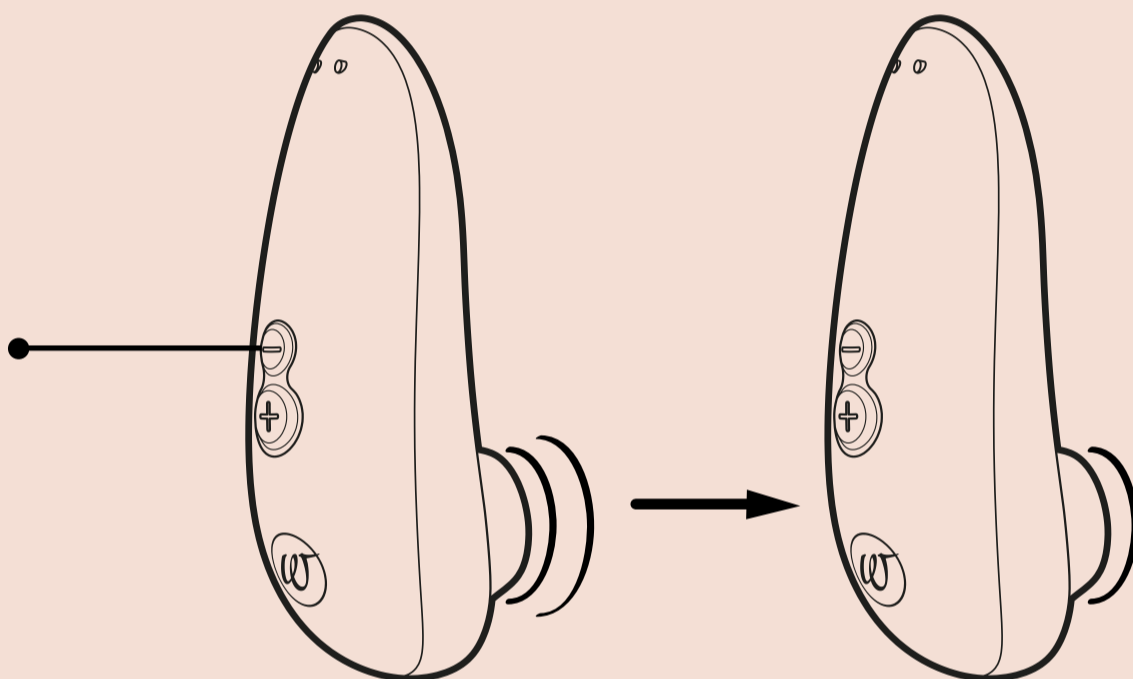

### 4. 끄기

누릅니다  
2 초 동안

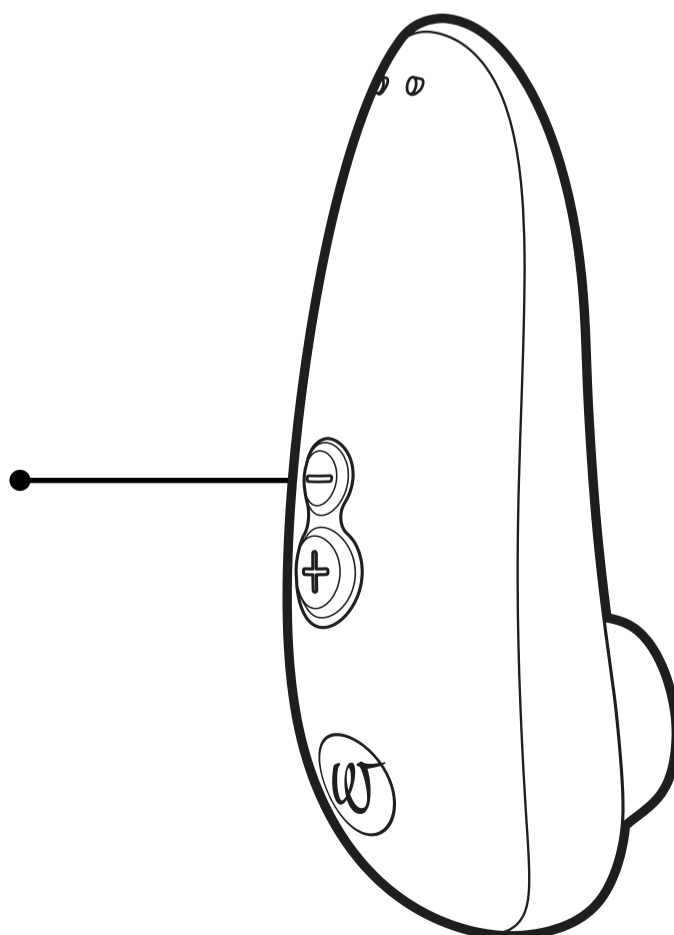

# 충전

처음 사용하기 전에 Womanizer를 충전해 주세요. 또한 긴 배터리 수명을 확보하려면 정기적으로 Womanizer를 재충전해야 한다는 것을 명심하세요.

충전  
USB 포트를 통해

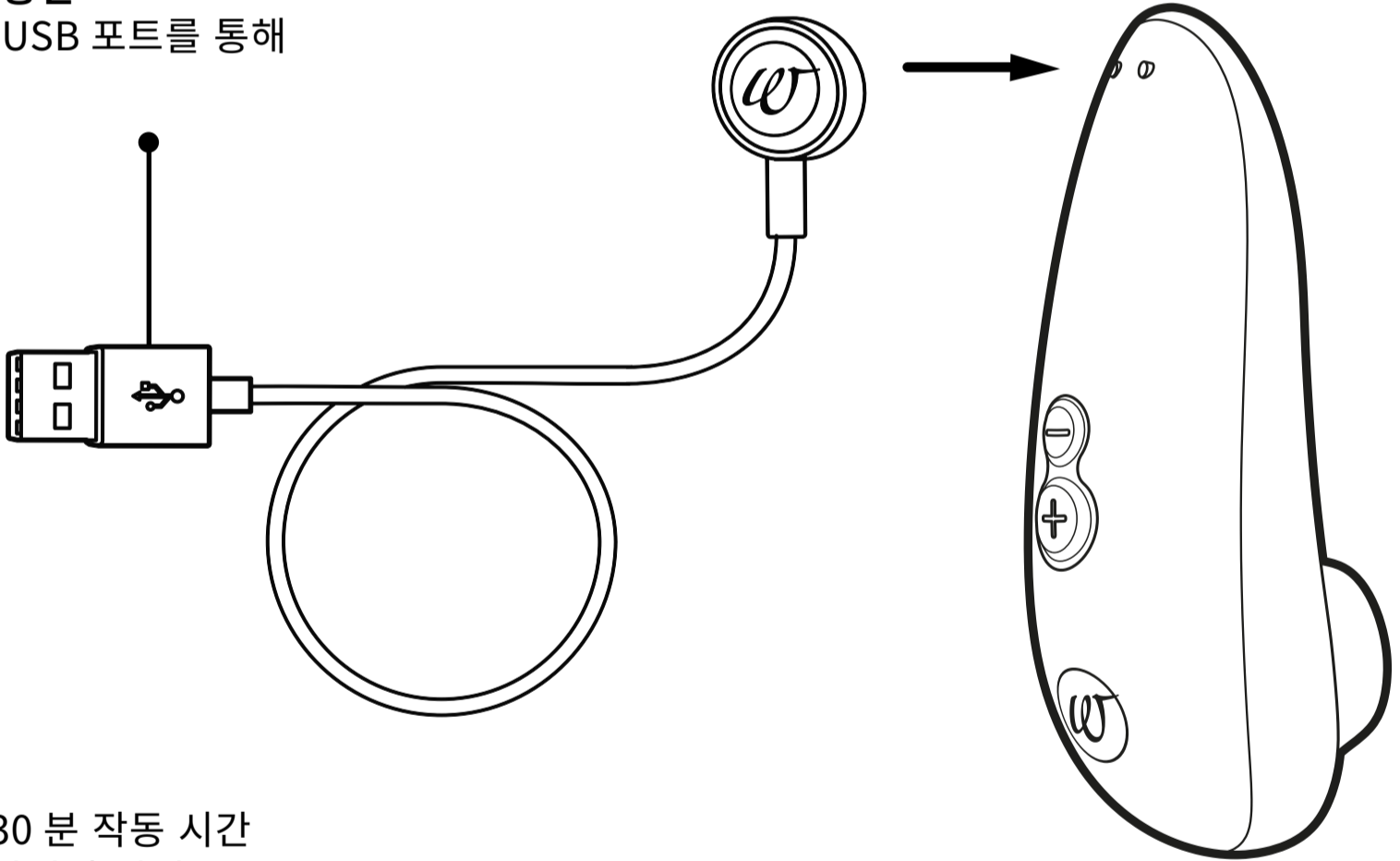

30 분 작동 시간  
완전 충전에 30 분

# 청소

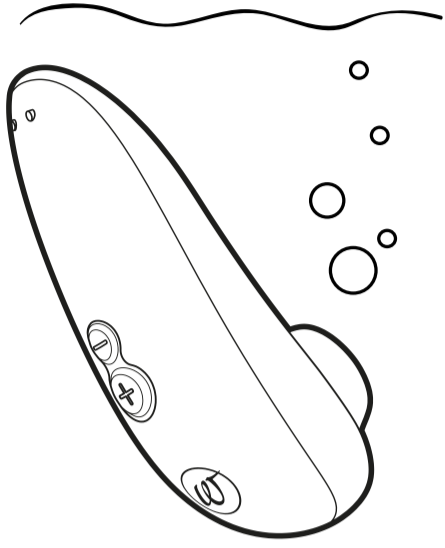

흐르는 물에 씻습니다

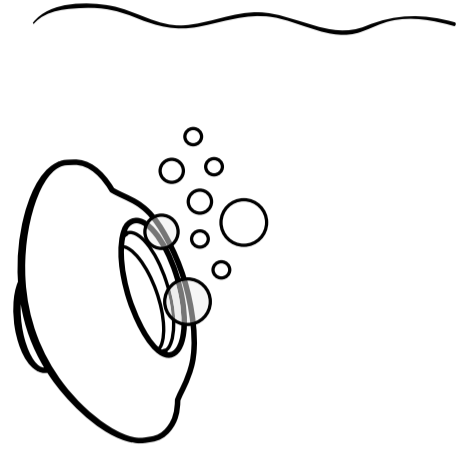

흐르는 물에 씻습니다

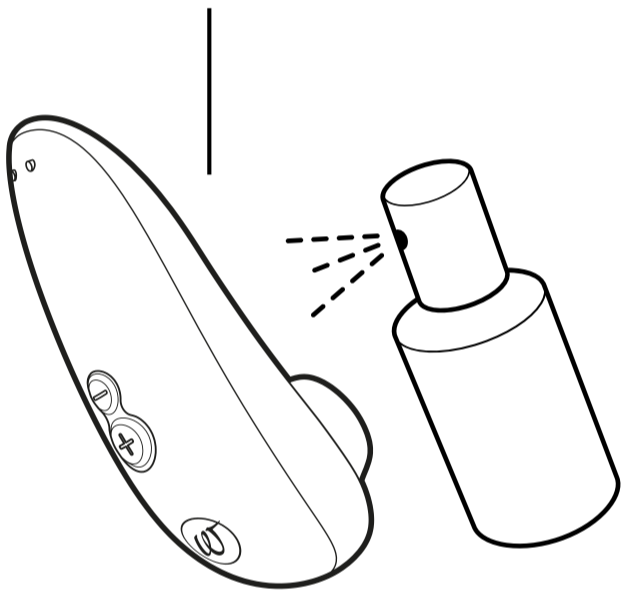

토이 클리너 사용

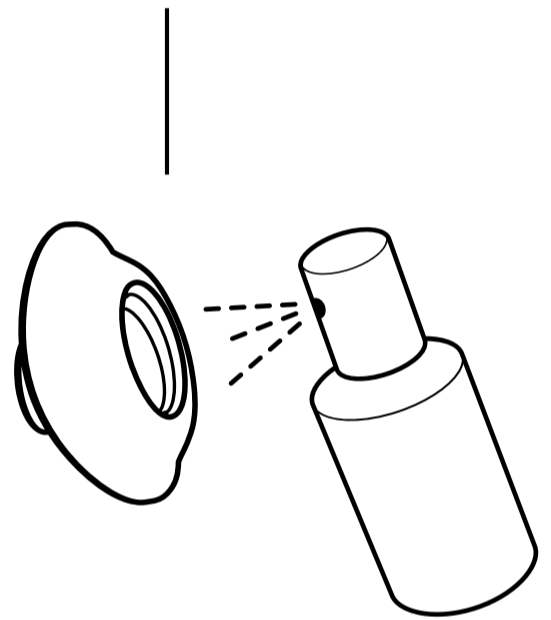

토이 클리너 사용

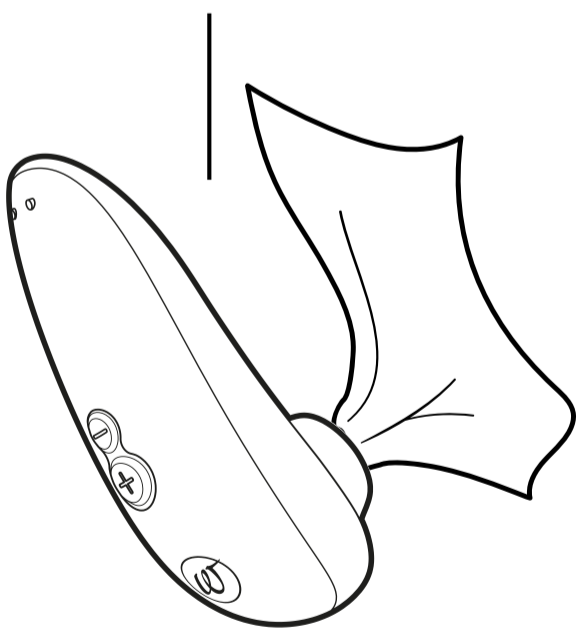

건조

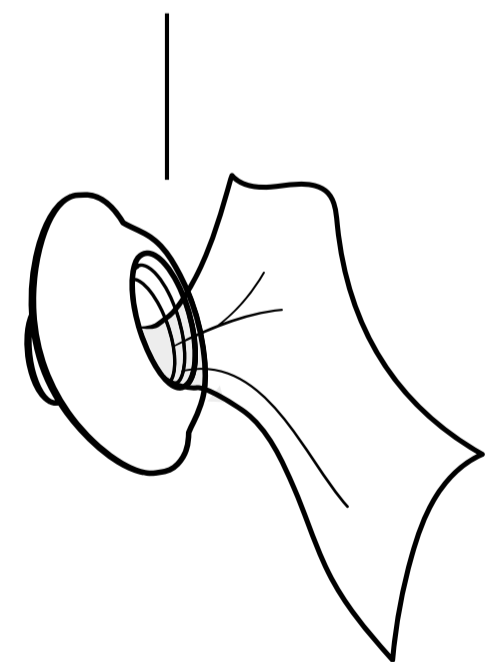

건조



Waterproof  
IPX7

# 일반 정보

## 경고

손상을 피하려면 Womanizer를 사용하는 동안 향기로운 알코올 기반이나 실리콘 기반의 윤활유 젤이나 마사지 오일을 사용하지 마세요.

감염 위험을 줄이려면 처음 사용하기 전과 사용 후에는 매번 Womanizer를 철저히 청소하세요.

## 고객 관리

추가 정보는 당사 웹사이트 [www.womanizer.com](http://www.womanizer.com)을 방문하거나 [care@womanizer.com](mailto:care@womanizer.com)에 연락하여 확인하시기 바랍니다.

## 기술 사양

모델: WZ15B

전기 등급: 3.7  $\approx$  0.135 A:

내장 리튬 이온 충전지.

5 V  $\approx$  0.75 A: USB로 충전 시.

충전 장치.

제품 등급과 부합하는 전력 출력을 가진 USB AC 어댑터(포함되지 않음) 급속 충전 어댑터는 사용하지 마세요.

## 납품 내용물

Womanizer Starlet 3, USB 충전 케이블, 퀵스타트 가이드, 안전 지침.

## 보관

직사 광선에 노출하지 말고 안전하고 건조한 장소에 보관하세요.

## 보증 및 자발적

### 제조사 보증

WOW TECH EUROPE GMBH에서는 소비자가 판매자에 대해 갖는 법적 보증권 외에 본 제품에 대한 자발적 제조사 보증을 고객에게 제공합니다.

자발적 제조사 보증에 관한 조건은 당사 웹사이트의 „보증 조건“ 항목에 있습니다.

## 기준 이행

본 기기는 전자기 호환성(EMC)에 관한 모든 기준과 부합합니다. 본 장치는 정확하게 그리고 본 사용 설명서의 지침에 따라 사용하는 한 안전하게 사용할 수 있습니다.

## 환경 보호

전자 장비 유통 회사로서, 당사는 무료로 폐기 전기 및 전자 장비 반환을 받아야 할 법적인 의무가 있습니다. 당사는 사용자는 사용한 배터리를 법적으로 반환할 법적인 의무가 있다고 명확하게 선언합니다. 절대로 전자 장비나 배터리를 가정 쓰레기에 담아 버리지 마세요. 하기 기호는 당사 전자 제품들에도 부착되는데 위의 사실을 명확하게 환기하고자 하는 것입니다.

## 배급사

WOW Tech Europe GmbH,  
Friedenstrasse 91 / 91 a, 10249 Berlin,  
Germany

WOW Tech Europe GmbH에서는 장치 개선에 도움이 되는 기술 및 설계 개선의 권리를 보유합니다.

북미 지역 유통 회사: 1545 Carling Avenue,  
Suite 401, Ottawa ON, Canada K1Z 8P9

[www.wowtech.com](http://www.wowtech.com) Designed in Germany. 2021년 중국에서 제조. 2021년 2월 매뉴얼 발행. 버전 1.

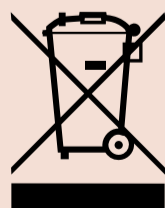

# 아직 더 원하세요?

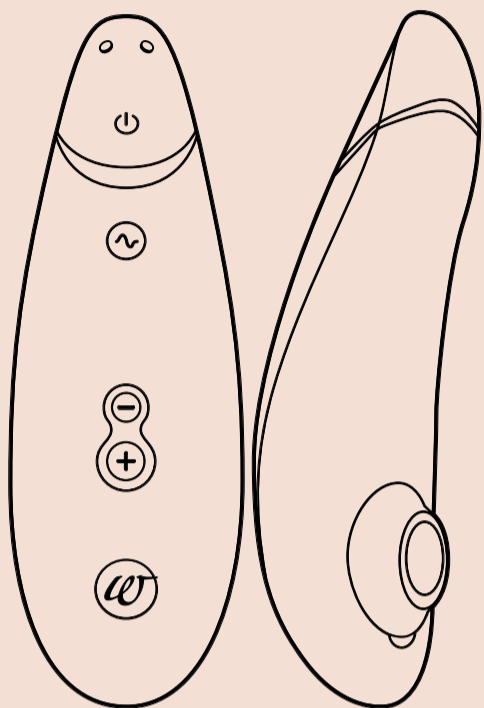

Pleasure Air  
Technology



Smart Silence

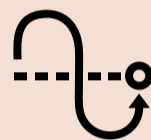

Autopilot

## Premium 2

Define your luxury

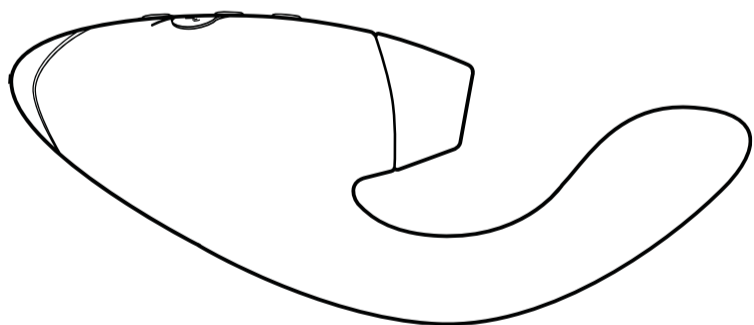

Pleasure Air  
Technology



Vibrator



Smart Silence

## DUO

Double your Pleasure



**#IMASTURBATE**

# 嗨！

**Womanizer를 선택해 주셔서 감사합니다!**

歡迎探索快感迭起的情趣世界，生活從此更加豐富多彩。選擇 WOMANIZER，您不僅可以享受無與倫比的美好高潮，還能擁有全新的歡愉慾望。

**享受 WOMANIZER - 帶給您一次又一次的高潮**

好好愛自己！





產品說明

如何使用

充電

清潔

一般資訊

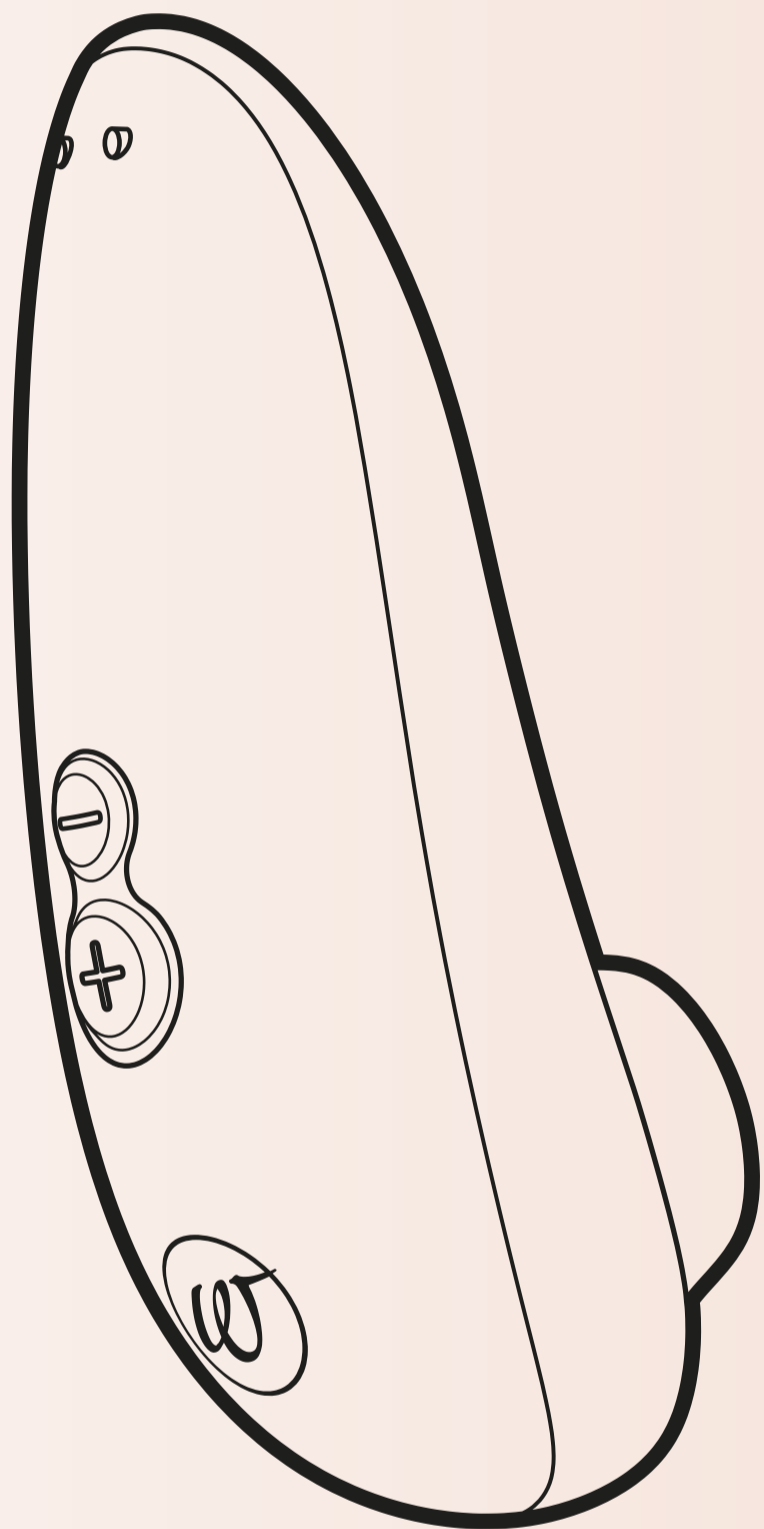

# 產品說明

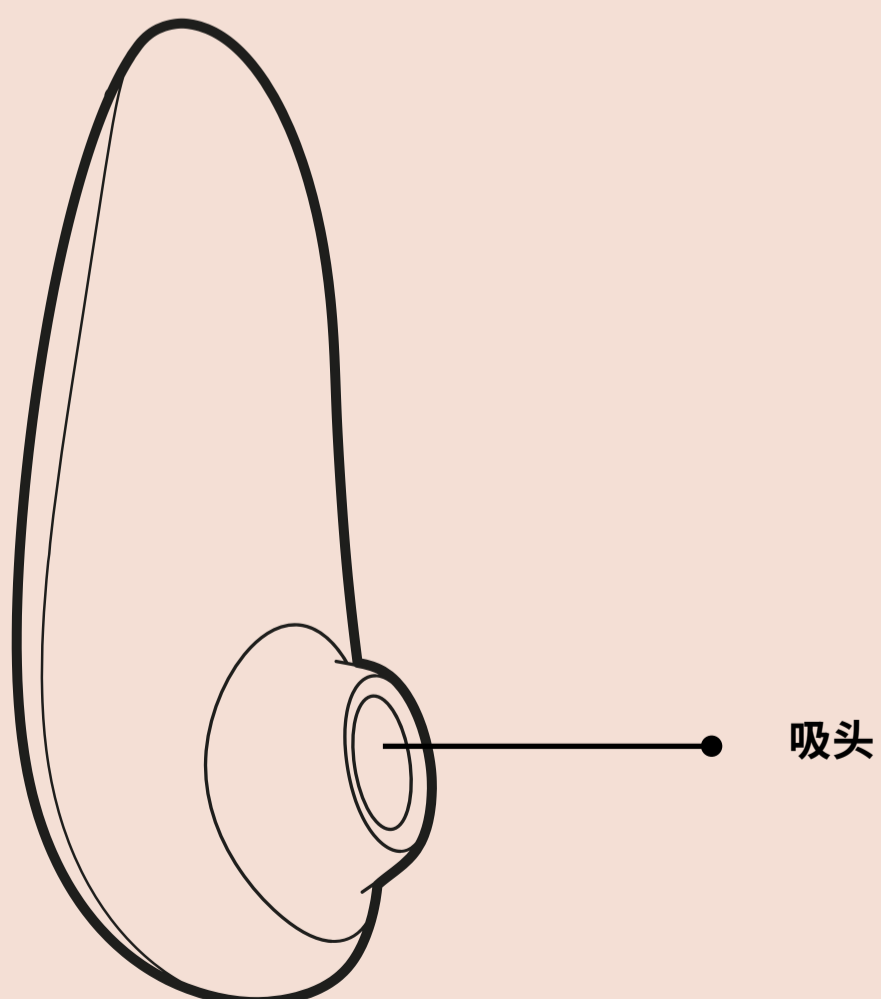
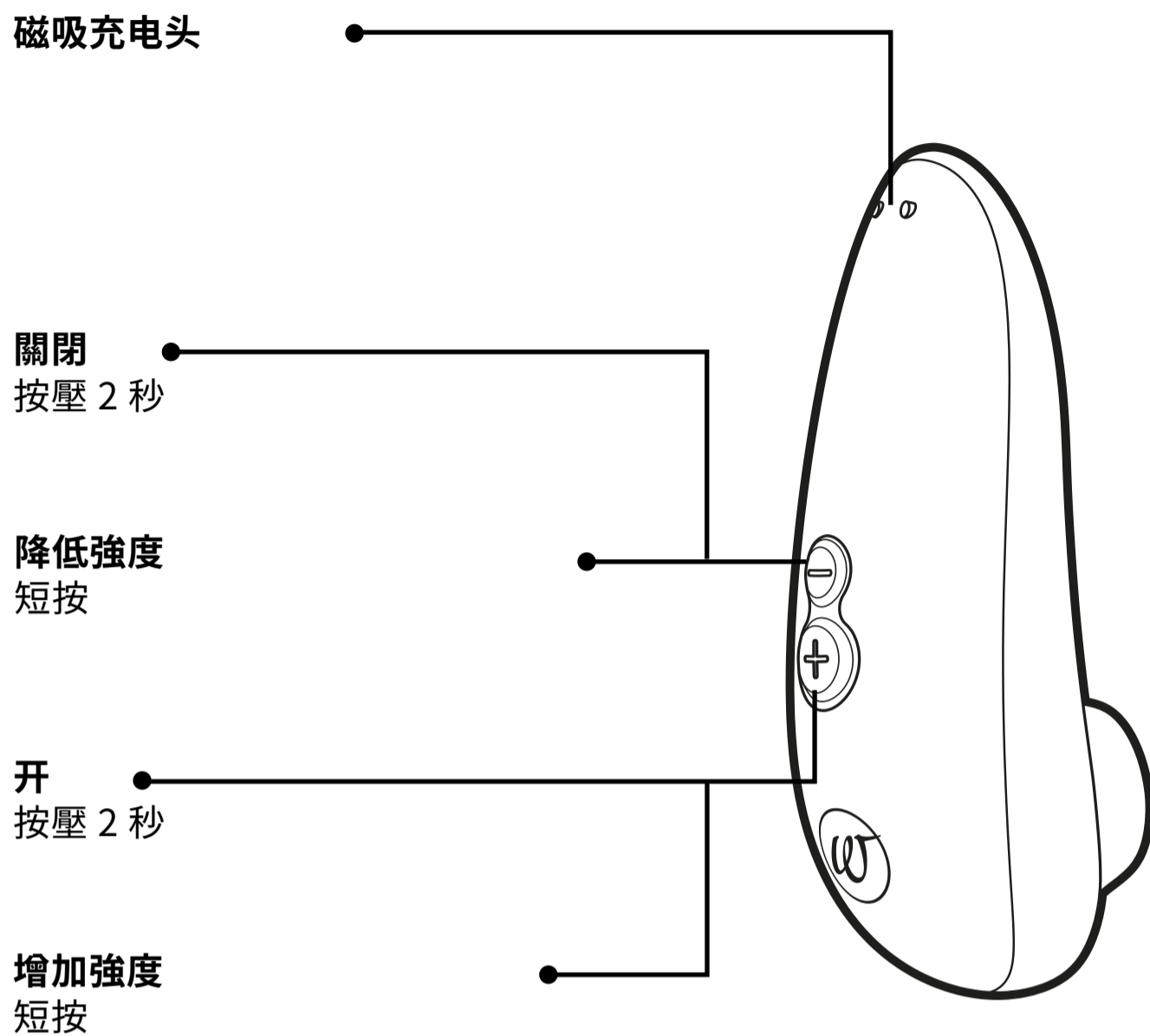

# 如何使用

## 1. 開啟電源

按壓  
2 秒

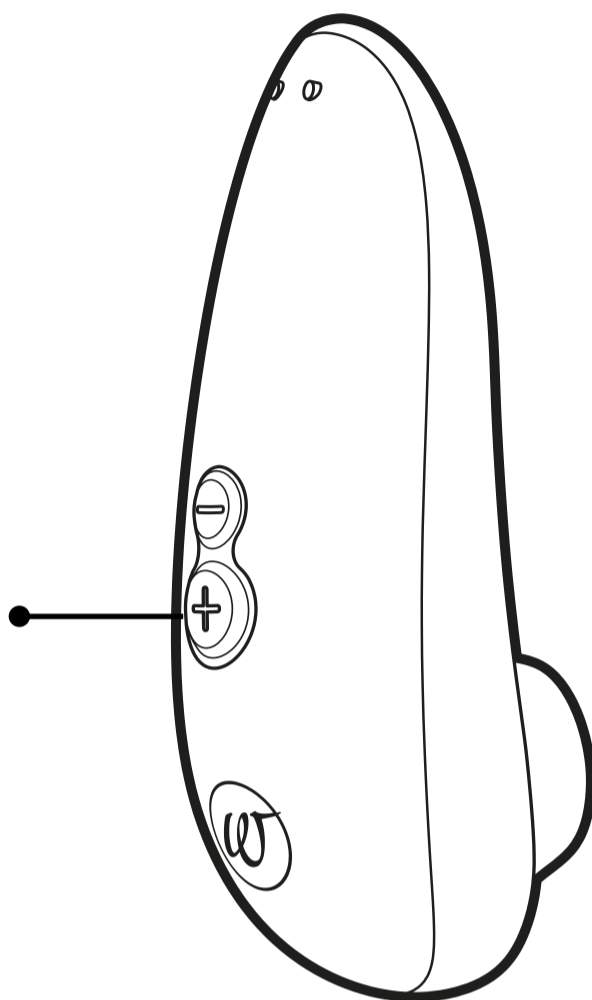

## 2. 使用方法

用吸吮頭裹含陰蒂, 開啟唯妳獨享的美妙時光。

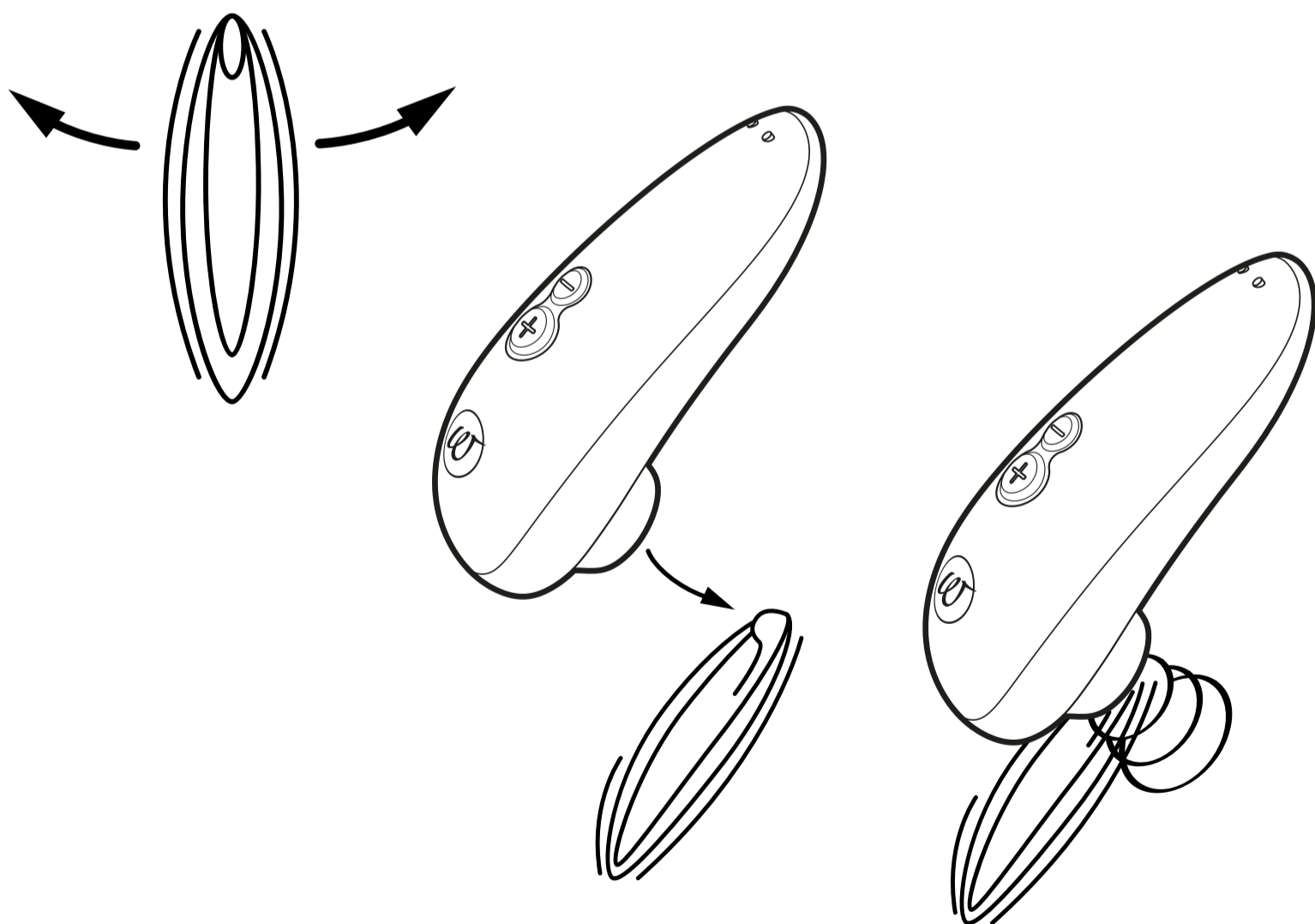

### 3. 改变强度

增加  
短按

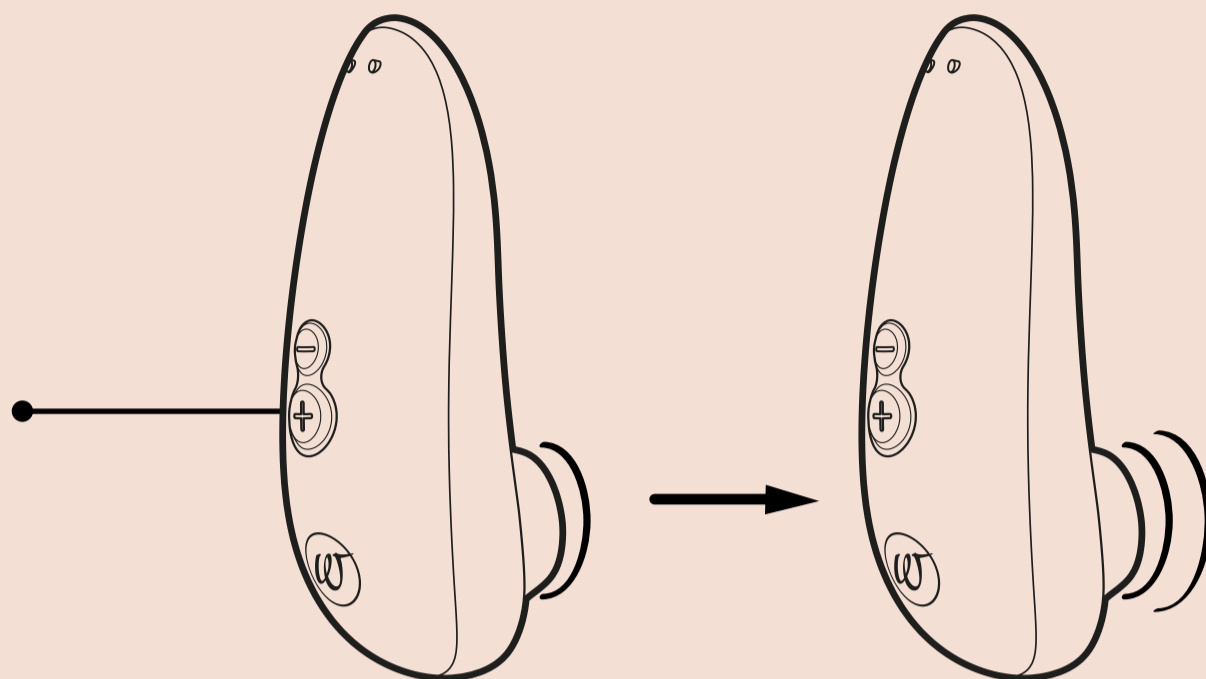

6  强度選擇

降低  
短按

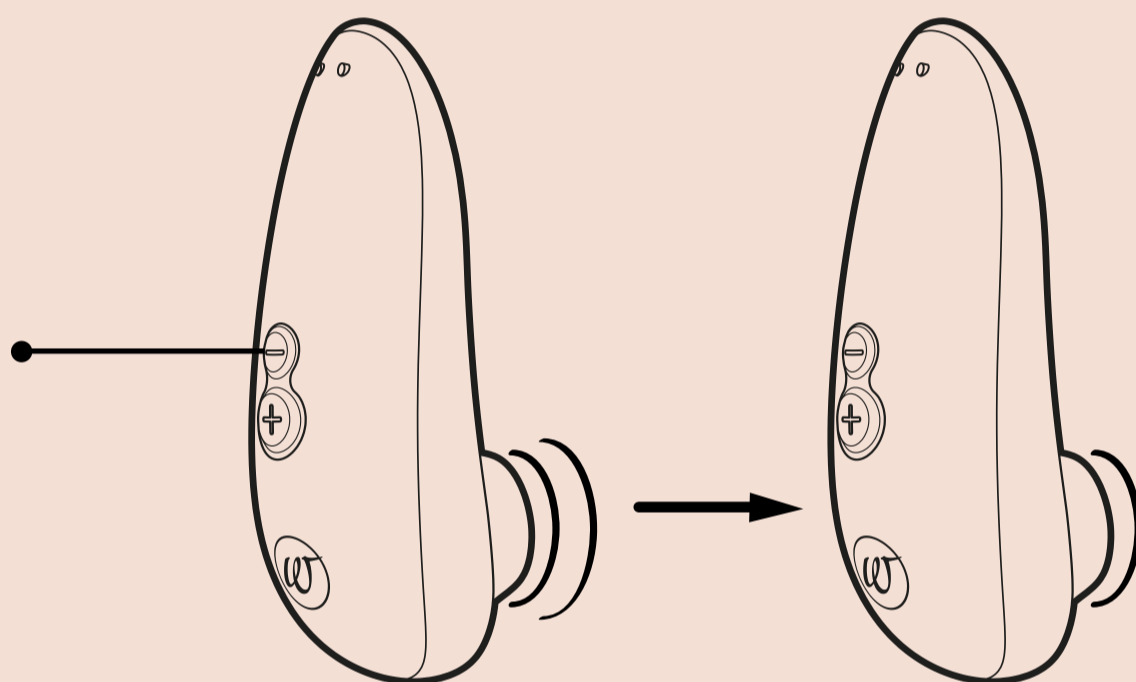

### 4. 關閉

按壓  
2 秒

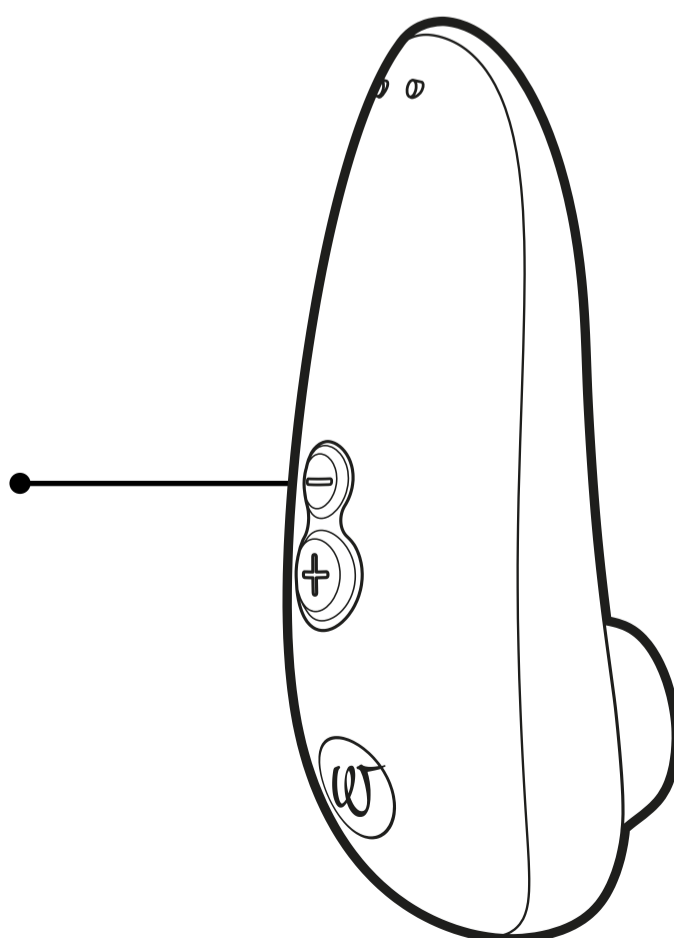

# 充電

請在首次使用前為您的 Womanizer 充電。同時也請記住應定期為 Womanizer 充電, 確保電池能保有較長壽命。

充電  
透過 USB 埠

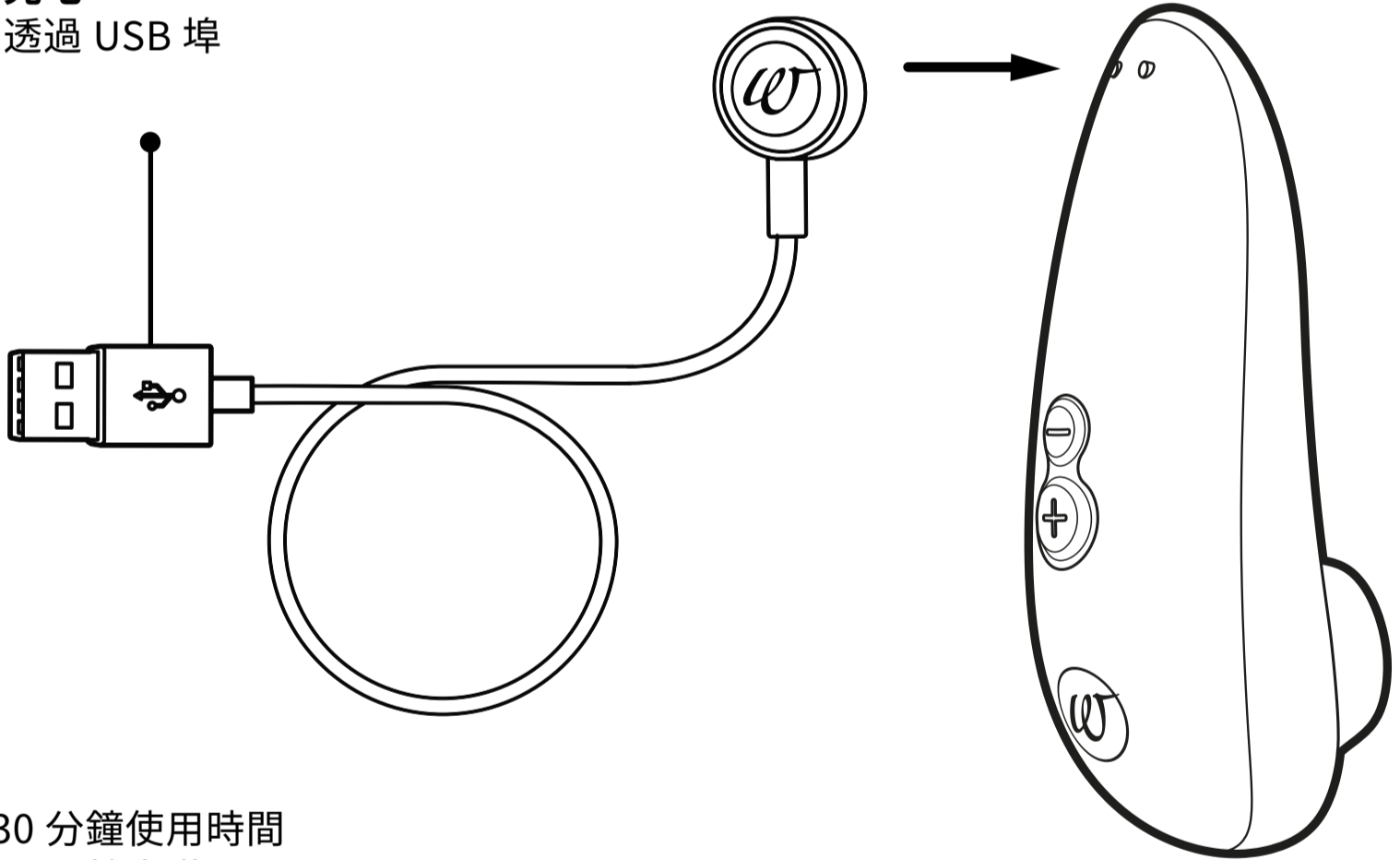

30 分鐘使用時間  
30 分鐘充滿電

# 清潔

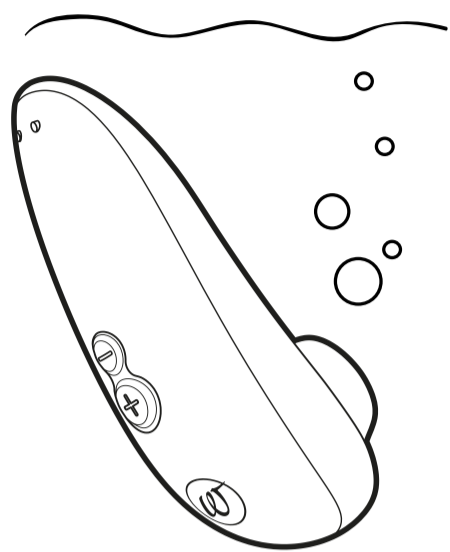

在水中清洗

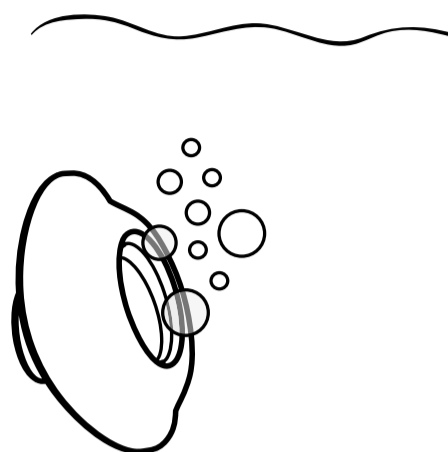

在水中清洗

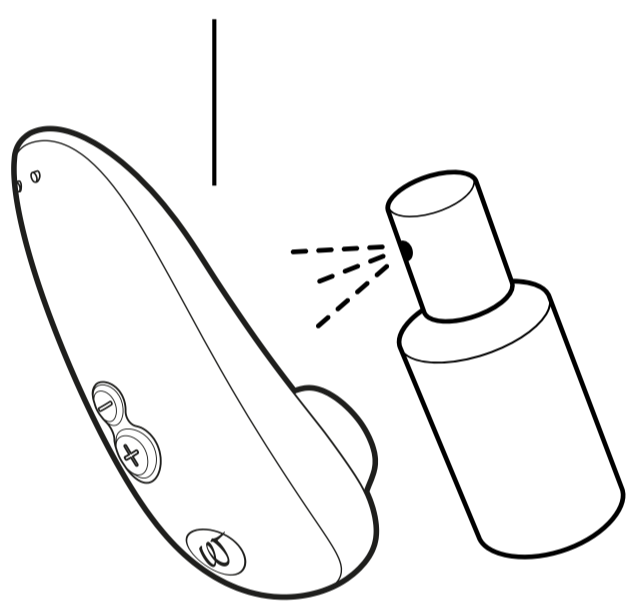

喷涂情趣玩具清洁剂

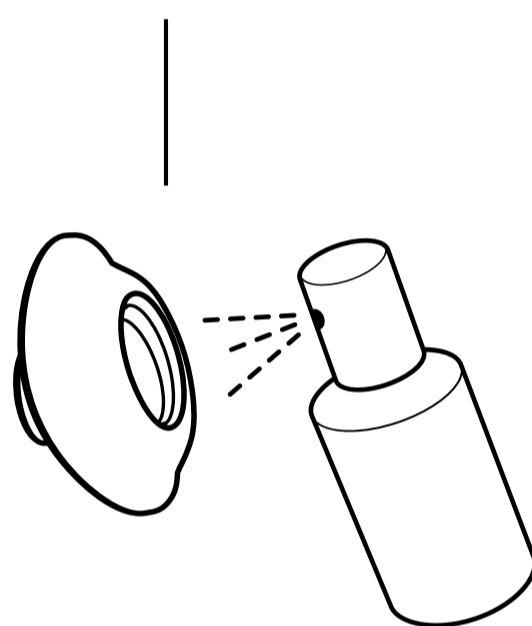

喷涂情趣玩具清洁剂

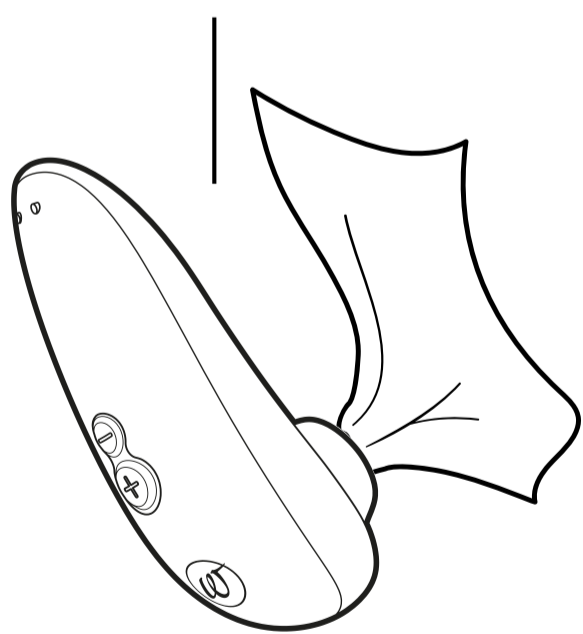

干燥

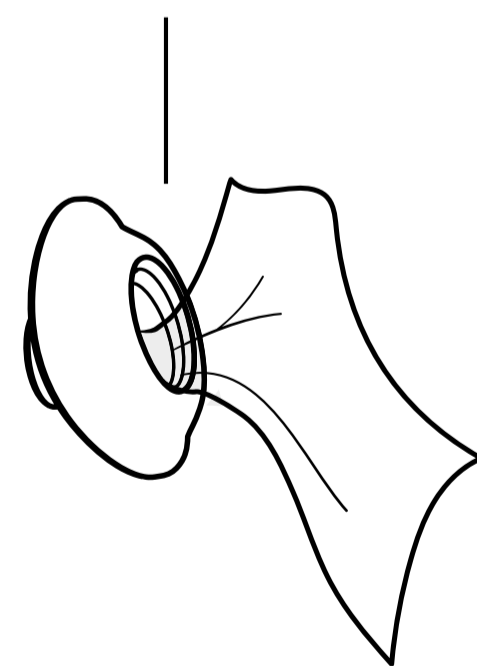

干燥



Waterproof  
IPX7

# 一般資訊

## 警告

使用 Womanizer 時，請勿使用含有香水、酒精或矽酮的潤滑劑或按摩油，以免損壞。  
首次使用前和每次使用後，請徹底清潔 Womanizer，以降低感染風險。

## 客户服务

若需要更多信息，请访问我们的网站 [www.womanizer.com](http://www.womanizer.com) 或联系 [care@womanizer.com](mailto:care@womanizer.com)。

## 技術規格型號

型號：WZ15B  
電功率額定值：3.7 W @ 0.135 A：  
內建鋰離子充電電池。  
5 V @ 0.75 A：使用 USB 充電時。  
充電裝置：  
輸出功率與產品額定值相符的 USB AC 轉接器（不含在內）。請勿使用快速充電轉接器。

## 包裝內容

Womanizer Starlet 3、USB 充電線、快速入門指南、安全說明書。

## 儲存

儲存在安全、乾燥的地方，避免陽光直射。

## 保固和製造商

### 自願保固

除了製造商為消費者提供的法定保固外，WOW TECH EUROPE GMBH 還為客戶提供針對本產品的製造商自願保固。  
關於製造商自願保固的條件，請參見我們網站上的「保固條件」。

## 合规性

本設備符合所有電磁相容性 (EMC) 相關標準。只要按照本使用者手冊中的說明正確使用本設備，就能確保使用安全。

## 环境保护

作為電子設備的經銷商，我們在法律上有義務免費協助回收廢棄電器與電子設備。我們明確聲明，用戶有法律義務回收廢舊電池。切勿將電子設備或電池作為生活垃圾丟棄。  
下圖所示的符號（我們的電子產品上也有標示）正是為了明確提醒注意環保義務。

## 分销商

WOW Tech Europe GmbH,  
Friedenstrasse 91 / 91 a, 10249  
Berlin, Germany (德国)

WOW Tech Europe GmbH 保留为改进设备而变更技术或设计的权利。

北美經銷商：WOW TECH Canada Ltd.  
1545 Carling Avenue, Suite 401, Ottawa  
ON, Canada K1Z 8P9 (加拿大)

[www.wowtech.com](http://www.wowtech.com) 德國設計。中國製造（2021 年）。手冊於 02/2021 發行。第 1 版。

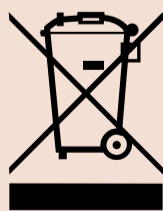



# 還想要更多？

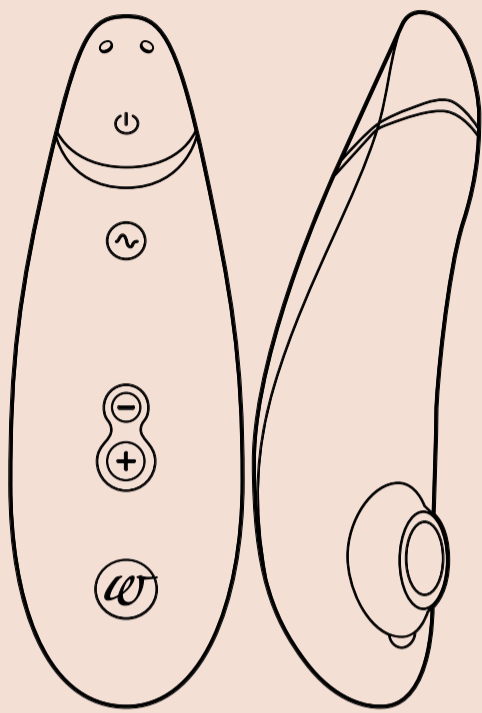

**Pleasure Air  
Technology**



**Smart Silence**

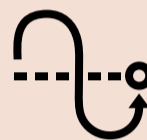

**Autopilot**

**Premium 2**  
Define your luxury

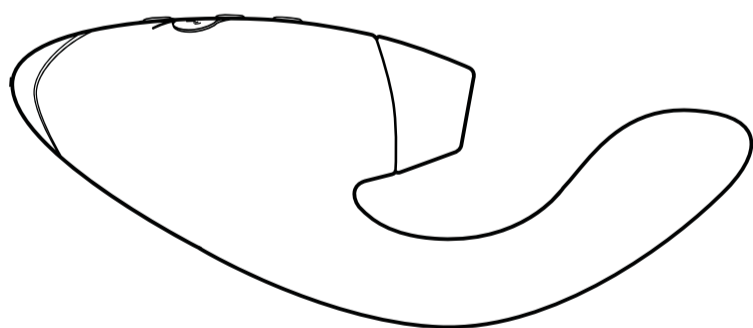

**Pleasure Air  
Technology**



**Vibrator**



**Smart Silence**

**DUO**  
Double your Pleasure



**#IMASTURBATE**

# こんにちは!

**Womanizer をご購入いただき、ありがとうございます!**

セックスライフを豊かに彩る官能の世界にようこそ。WOMANIZER なら、至高のオーガズムを感じることもできるだけでなく、新たな歓びの世界を発見できるはずです。

**WOMANIZER と共に、エンドレスな官能を体感しましょう。**

あなたに、心からの愛を!



製品説明

使用方法

充電

お手入れ

一般情報

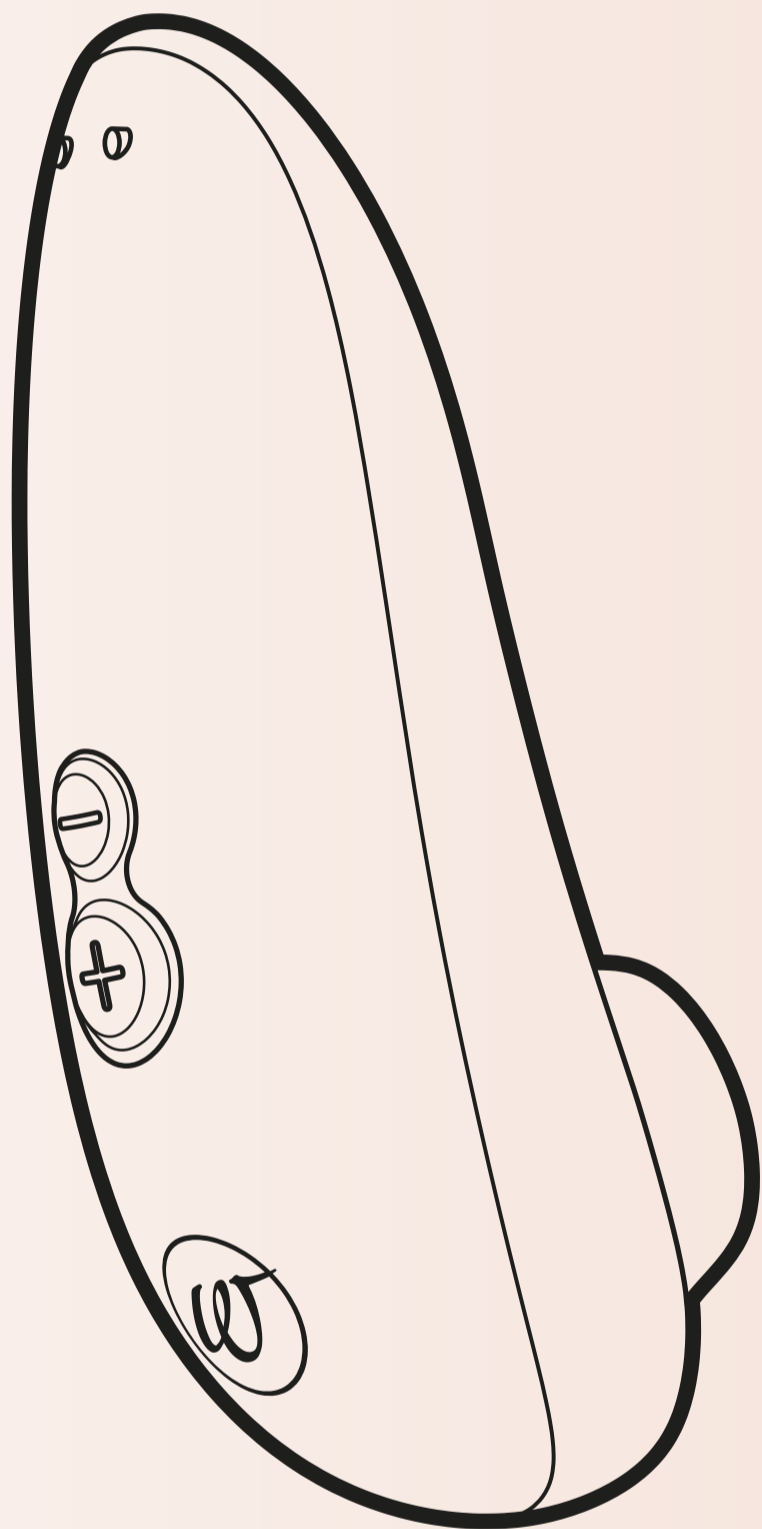

# 製品説明

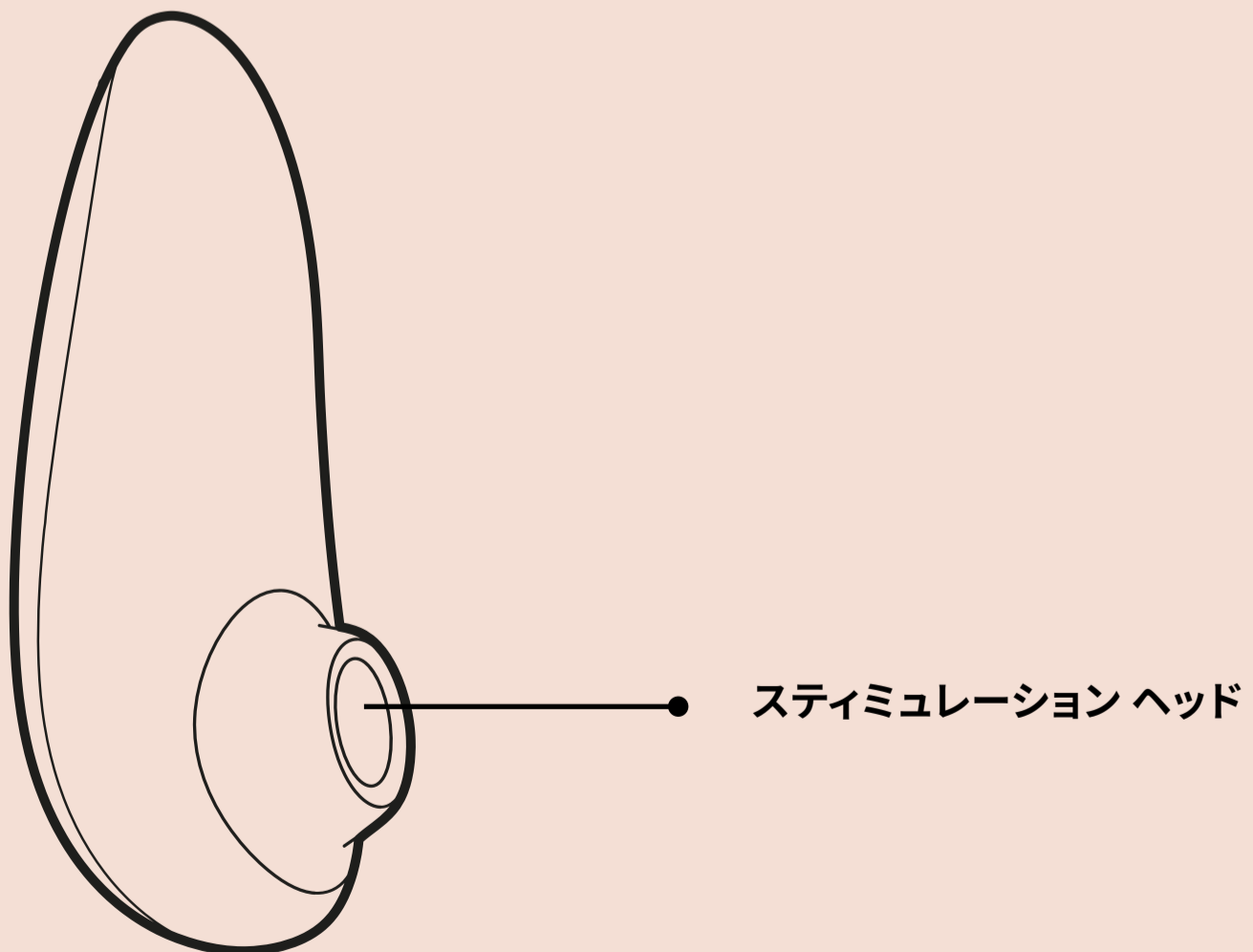
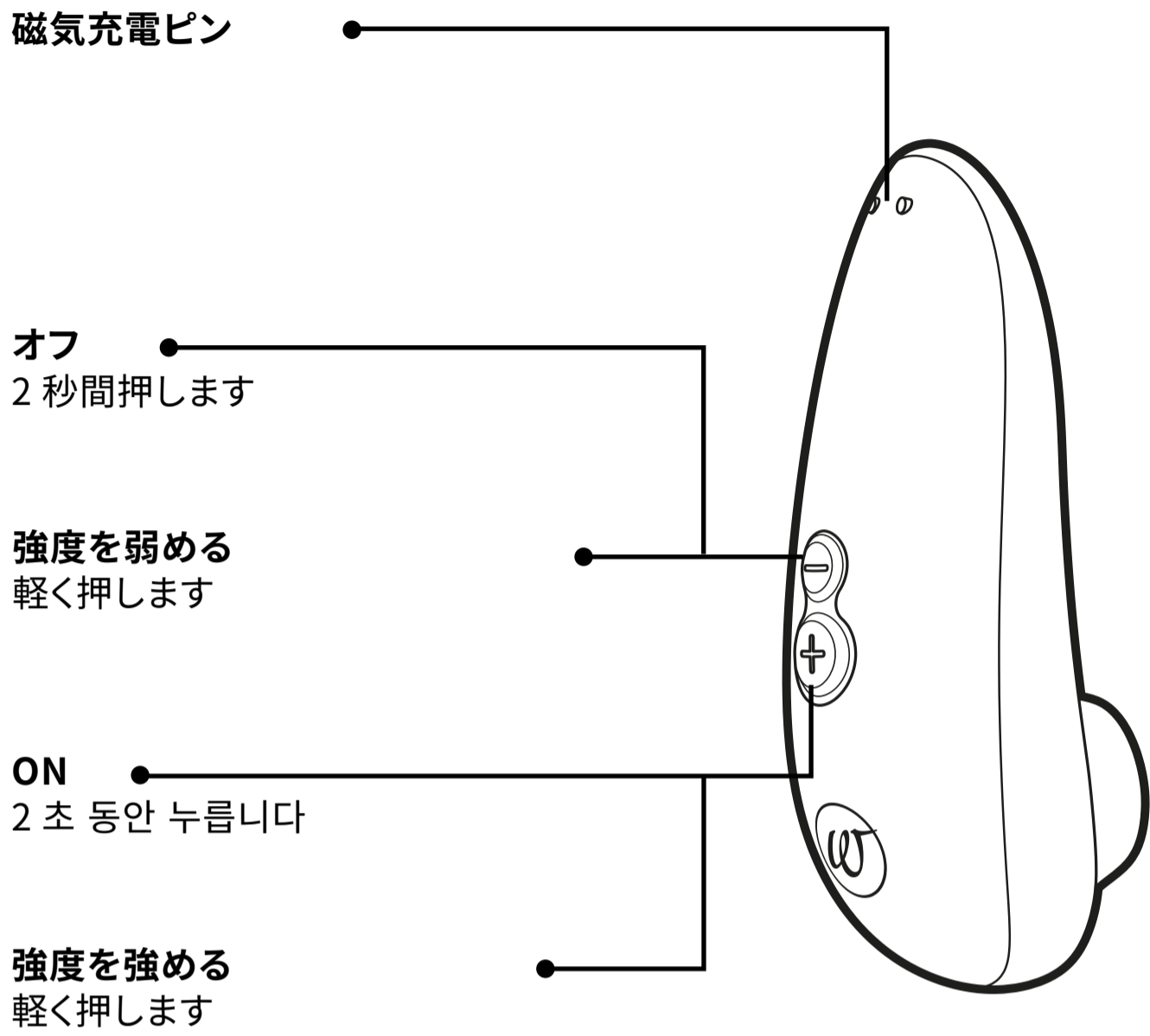

# 使用方法

## 1. 電源を入れる

スイッチを  
2 秒間押します

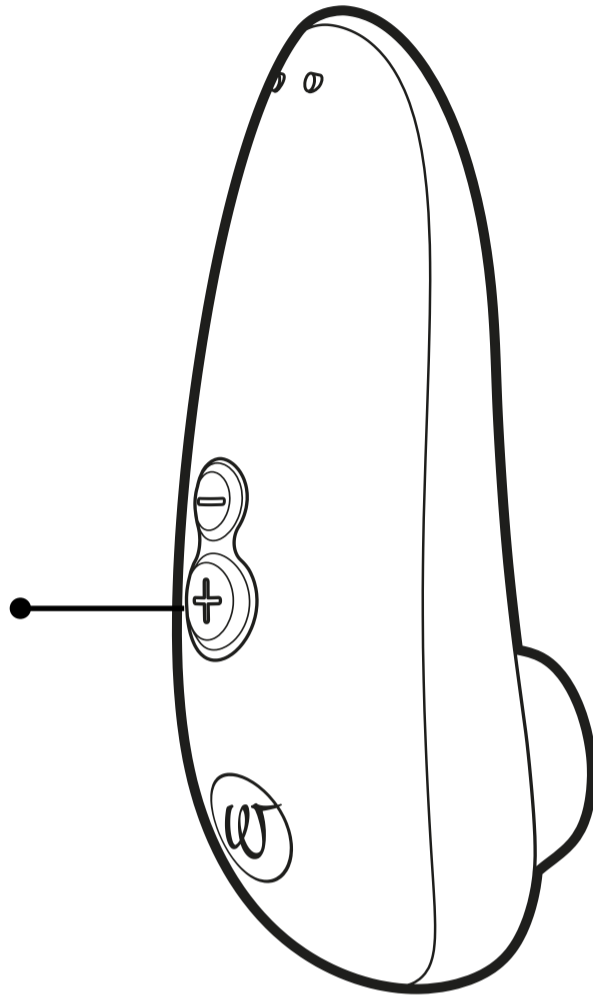

## 2. 使い方

ステイミュレーター ヘッドでクリトリスを包みます。

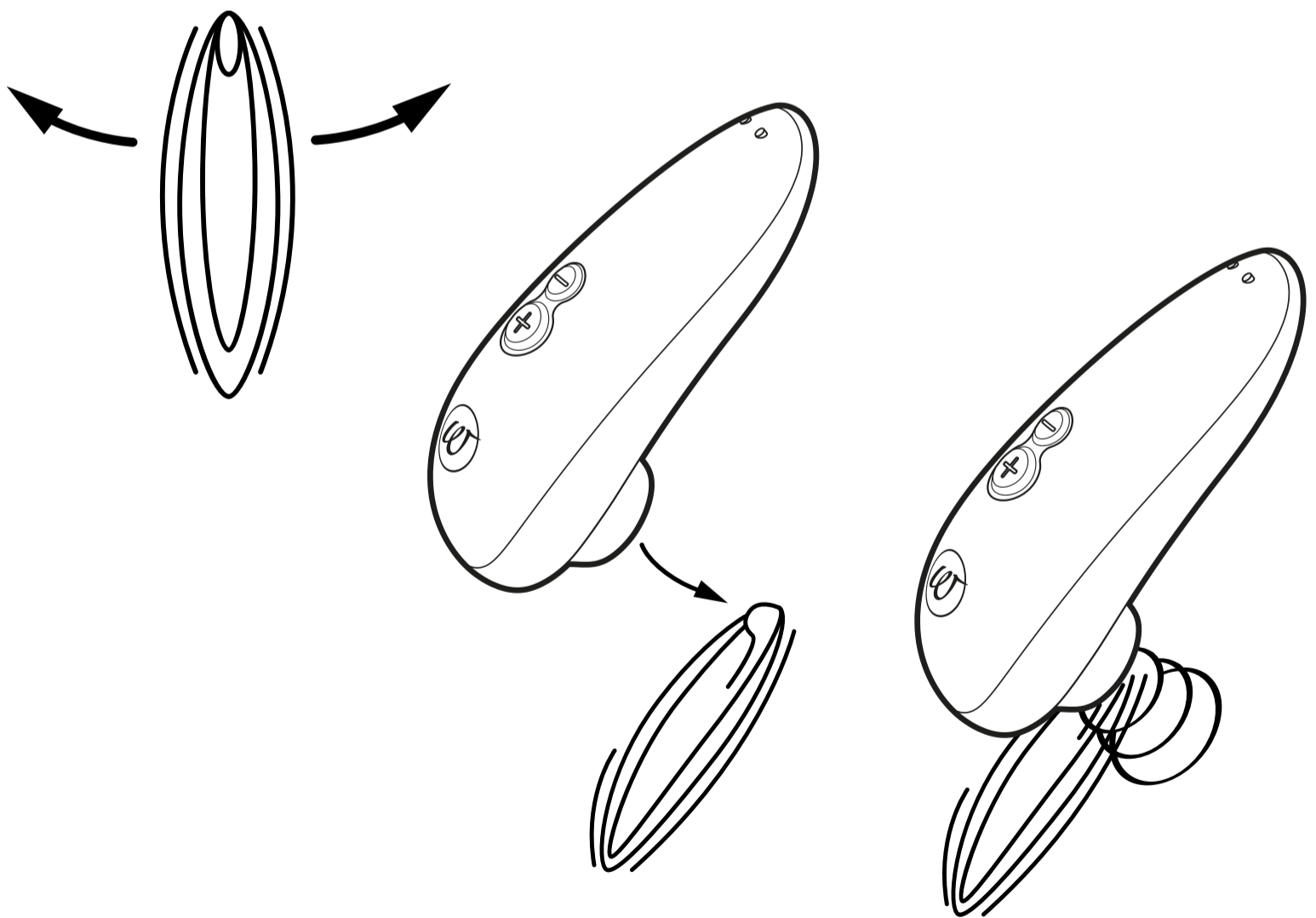

### 3. 強度の切替え

強くする  
軽く押します

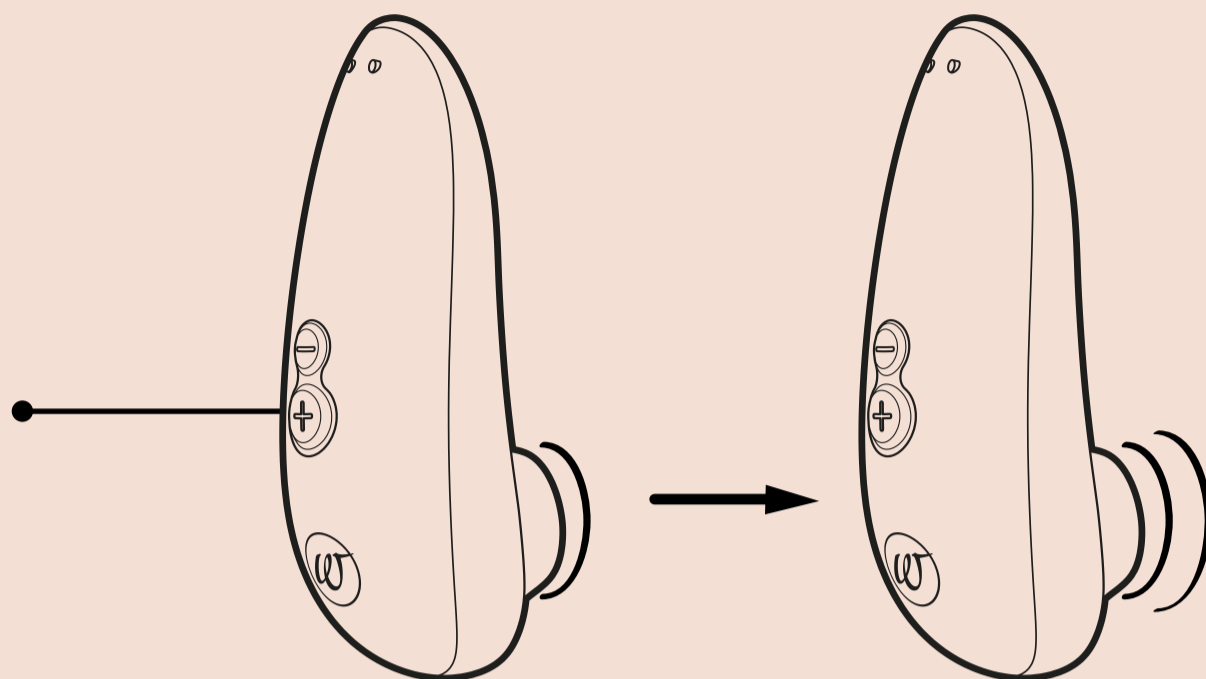

6  強度レベル

弱くする  
軽く押します

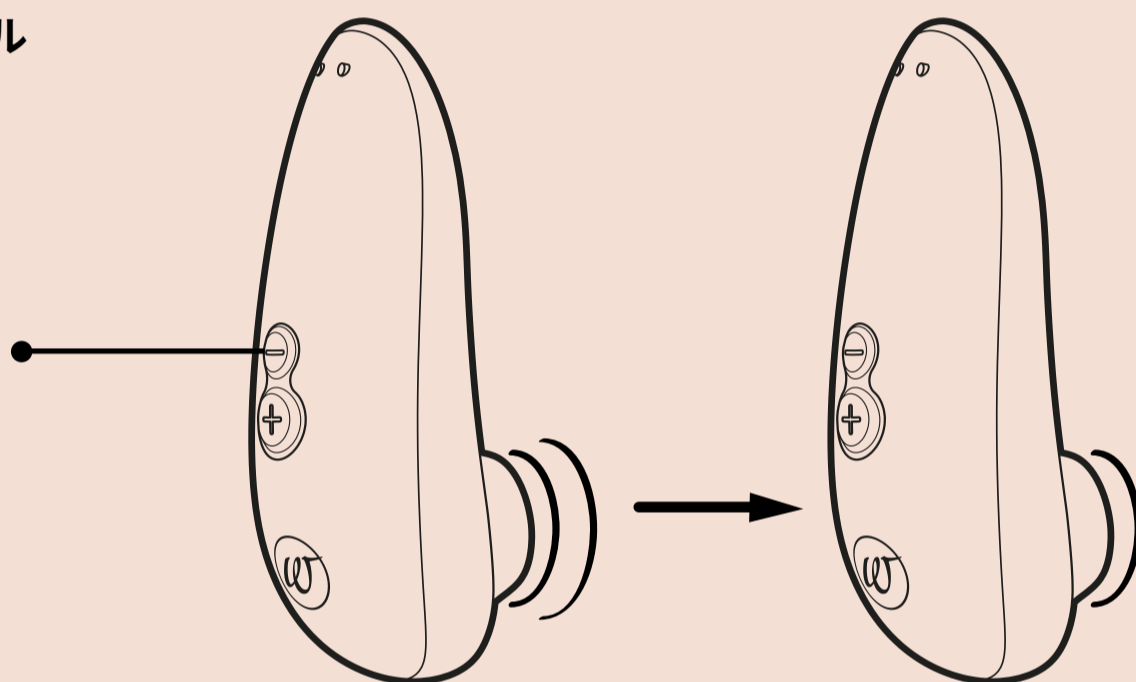

### 4. 電源を切る

スイッチを  
2 秒間押します

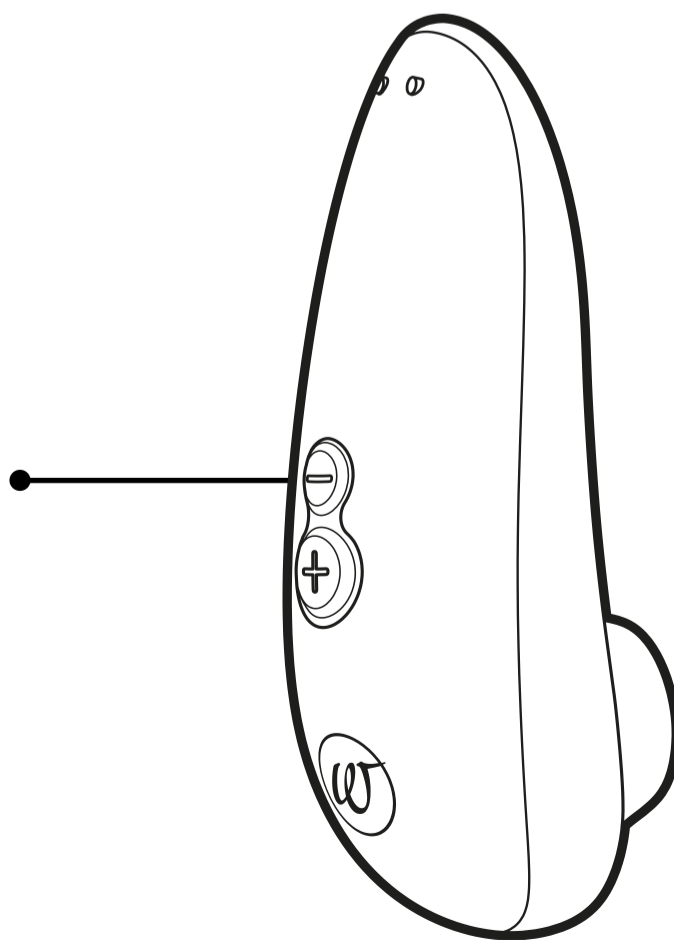



# 充電

Womanizer を初めて使用する前に、充電してください。バッテリーの寿命をできるだけ長く保つため、デバイスは、定期的に充電してください。

充電  
USB ポート

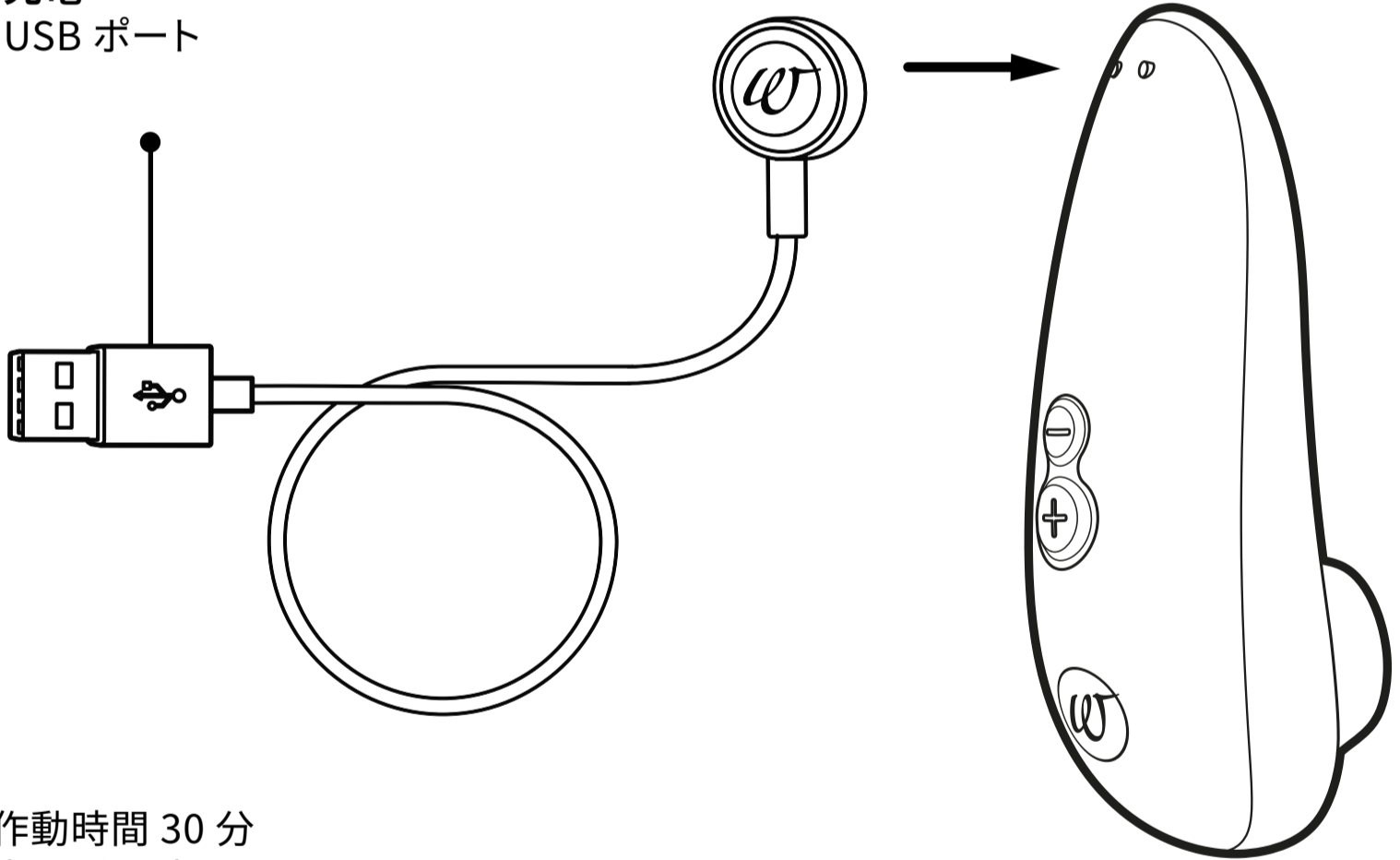

作動時間 30 分  
充電所要時間 30 分

# お手入れ

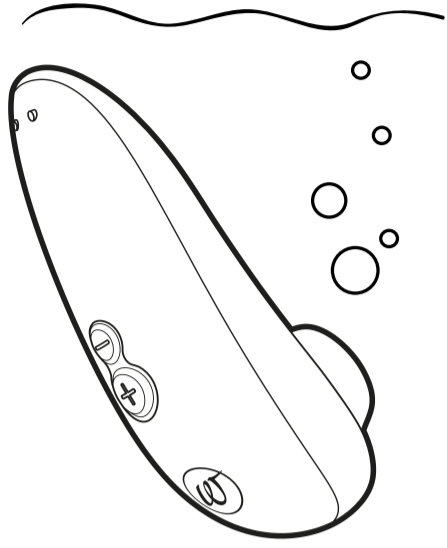

流水ですすぎ洗いしてください

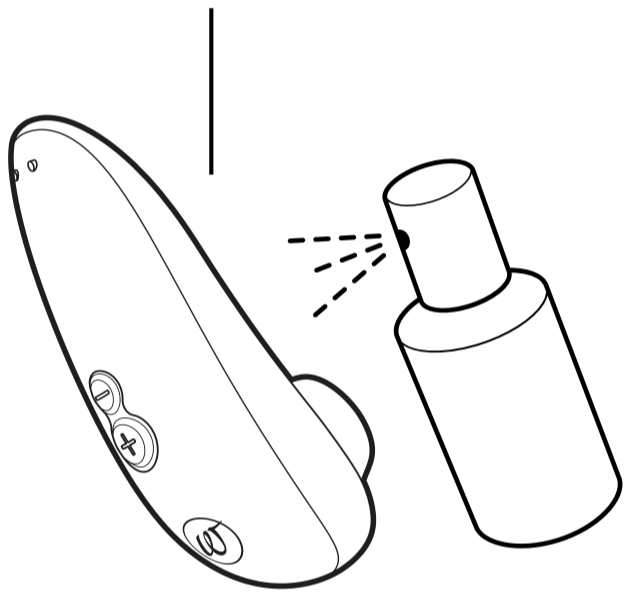

トイクリーナーを使用します

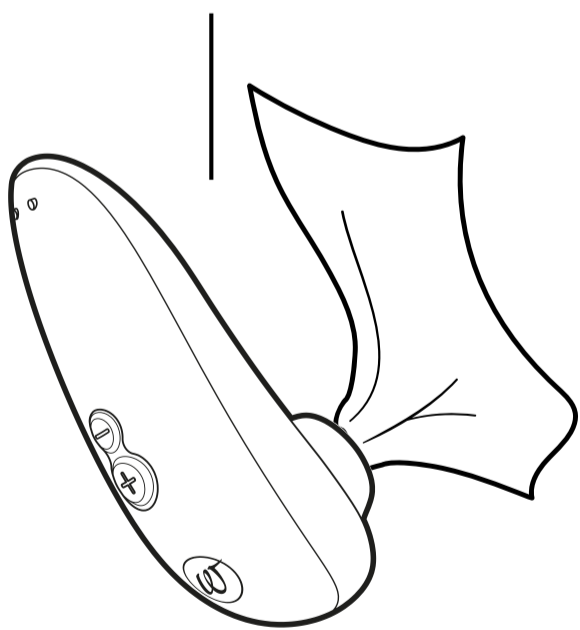

乾燥させます

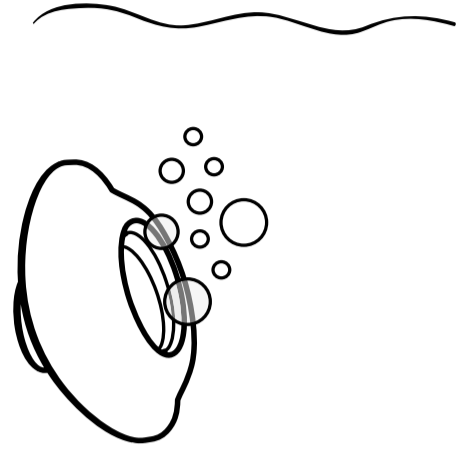

流水ですすぎ洗いしてください

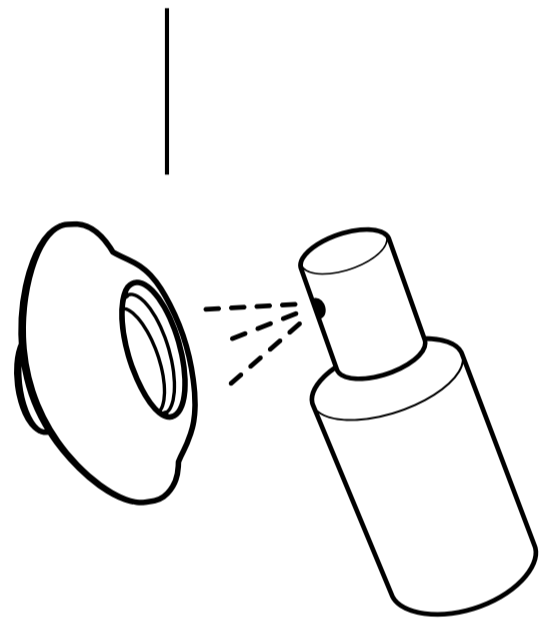

トイクリーナーを使用します

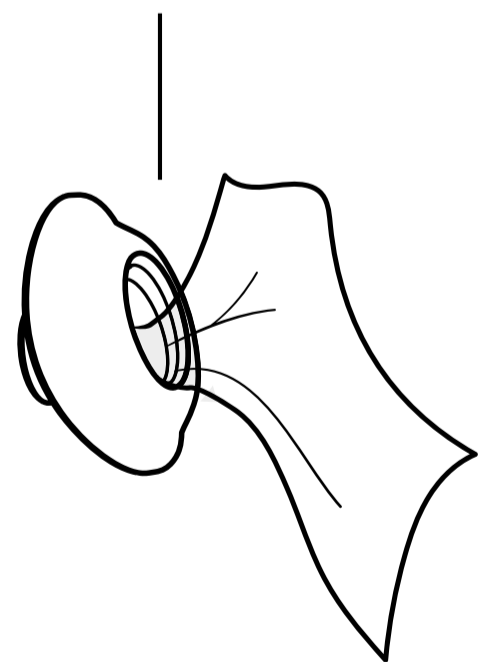

乾燥させます



Waterproof  
IPX7

# 一般情報

## 警告

損傷を防ぐため、Womanizer を使用する際、香料、アルコール、シリコンを配合した潤滑ジェルやマッサージオイルは使用しないでください。

初めて Womanizer を使用する前に、しっかりと洗浄してください。また、感染症のリスクを減らすため、使用後は必ず、洗浄してください。

## カスタマーケア

詳細情報は、当社ウェブサイト [www.womanizer.com](http://www.womanizer.com) を参照するか、[care@womanizer.com](mailto:care@womanizer.com) までお問い合わせください。

## 技術仕様書

モデル: WZ15B

電力定格: 3.7 V = 0.135 A:

搭載型リチウムイオン充電電池

5 V = 0.75 A: 充電には、USB を使用します。

充電デバイス:

製品の電力定格に対応した出力の USB AC アダプター (製品内容には含まれていません)

高速充電アダプターは使用しないでください。

## 製品内容

Womanizer Starlet 3、USB 充電ケーブル、クイックスタート ガイド、安全に関する指示。

## 保管

直射日光のあたらない、安全で乾いた場所に保管してください。

## 法定保証および

### メーカー保証

WOW TECH EUROPE GMBH では、販売者が消費者に対して実施する必要がある法定保証に加え、独自のメーカー保証を提供しています。

メーカー保証の条件は、当社ウェブサイトの「保証条件」に、記載されています。

## 基準

この保証は、電磁両立性 (EMC) に関する全ての基準に、準拠しています。デバイスは、当ユーザーマニュアルの指示に従い、適切に使用する限り、安全です。

## 環境保護

電子機器販売業者として、当社には、使用済みの電子機器廃棄物を、無料で引き取る法的義務が課せられています。そして、ユーザーであるお客様には、使用済みバッテリーを返却する義務が課せられています。ご注意ください。電子機器やバッテリーは、家庭ごみとして捨てないでください。

当社の電子アイテムに下記のシンボルが施されている場合は、家庭ごみとしての廃棄ができないことを意味しています。

## 造元

WOW Tech Europe GmbH,  
Friedenstrasse 91 / 91 a, 10249 Berlin,  
Germany

WOW Tech Europe GmbH は、デバイスを改良することを目的とした技術的変更、およびデザインの変更を行う権利を、保持しています。

北米担当販売代理業者: 1545 Carling Avenue, Suite 401, Ottawa ON, Canada K1Z 8P9

[www.wowtech.com](http://www.wowtech.com) デザイン: ドイツ製  
2021年中国製、マニュアル発行日: 02/2021  
バージョン 1

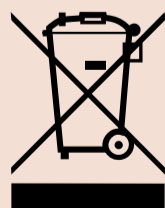

もっと知りたくなりましたか？

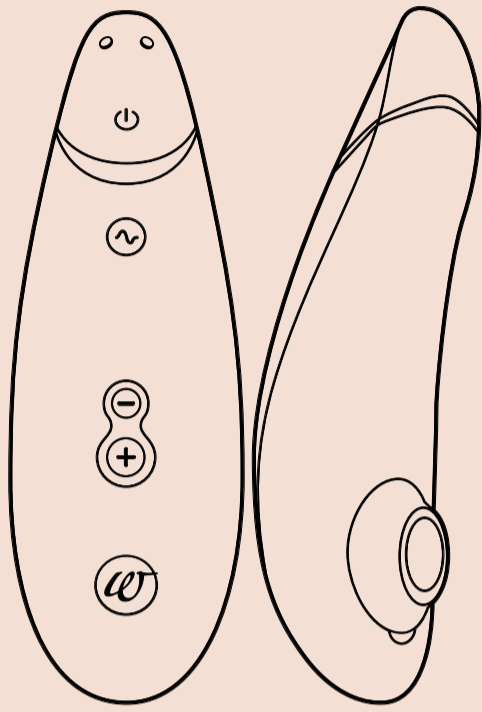

Pleasure Air  
Technology



Smart Silence

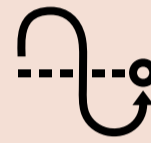

Autopilot

**Premium 2**  
Define your luxury

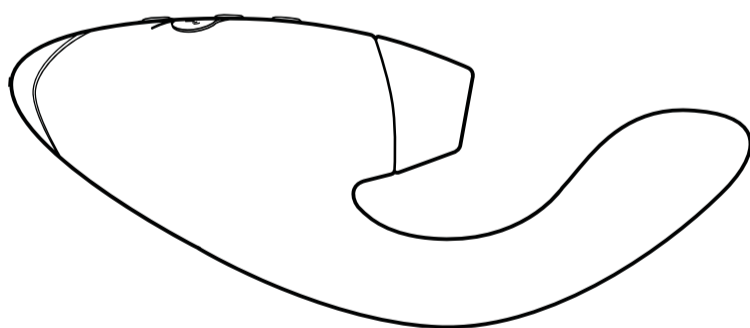

Pleasure Air  
Technology



Vibrator

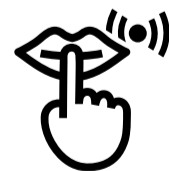

Smart Silence

**DUO**  
Double your Pleasure



**#IMASTURBATE**